

New ICMI Study Series

Maria G. Bartolini Bussi
Xu Hua Sun *Editors*

Building the Foundation: Whole Numbers in the Primary Grades

The 23rd ICMI Study



International Commission on
Mathematical Instruction



Springer Open

New ICMI Study Series

Published under the auspices of the International Commission
on Mathematical Instruction (ICMI)

Series Editors:

Jill Adler, ICMI President

Ferdinando Arzarello, ICMI Past President

Abraham Arcavi, ICMI Secretary General

Information on the ICMI Study programme and on the resulting publications can be obtained at the ICMI website <http://www.mathunion.org/ICMI/> or by contacting the ICMI Secretary General, whose email address is available on that website.

More information about this series at <http://www.springer.com/series/6351>

Maria G. Bartolini Bussi • Xu Hua Sun
Editors

Building the Foundation: Whole Numbers in the Primary Grades

The 23rd ICMI Study

 Springer Open

Editors

Maria G. Bartolini Bussi 
Department of Education and Humanities
University of Modena and Reggio Emilia
Modena, Italy

Xu Hua Sun 
Faculty of Education
University of Macau
Macao, China

Additional material to this book can be downloaded from <http://extras.springer.com>.



ISSN 1387-6872

ISSN 2215-1745 (electronic)

New ICMI Study Series

ISBN 978-3-319-63554-5

ISBN 978-3-319-63555-2 (eBook)

<https://doi.org/10.1007/978-3-319-63555-2>

Library of Congress Control Number: 2017960195

© The Editor(s) (if applicable) and The Author(s) 2018. This book is an open access publication.

Open Access This book is licensed under the terms of the Creative Commons Attribution 4.0 International License (<http://creativecommons.org/licenses/by/4.0/>), which permits use, sharing, adaptation, distribution and reproduction in any medium or format, as long as you give appropriate credit to the original author(s) and the source, provide a link to the Creative Commons license and indicate if changes were made.

The images or other third party material in this book are included in the book's Creative Commons license, unless indicated otherwise in a credit line to the material. If material is not included in the book's Creative Commons license and your intended use is not permitted by statutory regulation or exceeds the permitted use, you will need to obtain permission directly from the copyright holder.

The use of general descriptive names, registered names, trademarks, service marks, etc. in this publication does not imply, even in the absence of a specific statement, that such names are exempt from the relevant protective laws and regulations and therefore free for general use.

The publisher, the authors and the editors are safe to assume that the advice and information in this book are believed to be true and accurate at the date of publication. Neither the publisher nor the authors or the editors give a warranty, express or implied, with respect to the material contained herein or for any errors or omissions that may have been made. The publisher remains neutral with regard to jurisdictional claims in published maps and institutional affiliations.

Printed on acid-free paper

This Springer imprint is published by Springer Nature

The registered company is Springer International Publishing AG

The registered company address is: Gewerbestrasse 11, 6330 Cham, Switzerland

Foreword

The International Commission on Mathematical Instruction (ICMI) was established at the Fourth International Congress of Mathematicians held in Rome in 1908. It was initiated to support active interests in school education which were widespread among mathematicians at the time. ICMI is crucial for the [International Mathematical Union](#) (IMU), because education and research cannot be separated from each other. ICMI and the IMU function together for mathematics like the two wheels of a cart, since ICMI develops education systems which enable mathematics to prevail in society, while the IMU contributes to society through the development of pure and applied mathematical sciences.

I have been serving the IMU as President since January 2015. Since I served the IMU previously (1995–2002), I have noticed that ICMI and the IMU are working together to establish collaborations given that mathematics education is a major preoccupation of most scientific organisations nowadays.

My first physical involvement with ICMI as IMU President started with my participation in the ICMI Study 23 Conference in Macao in May/June 2015. The ICMI Study 23 was planned and run jointly by its local and foreign co-chairs, with support from the University of Macau. The International Program Committee (IPC) meeting of ICMI Study 23 in Berlin was also supported by the IMU Secretariat. I saw that the support and cooperation of ICMI and the IMU have been essential throughout these activities.

I was very pleased to learn that ICMI Study 23 addressed, for the first time, mathematics teaching and learning in primary school (and pre-school as well) for all, and I believe that it will have a larger impact for later mathematics knowing. I hope the volume supports the whole of mathematics education.

Kyoto University
Kyoto, Japan

Shigefumi Mori

Preface

I am particularly proud of the publication of this 23rd volume in the series of ICMI Studies, not only since this means that a long scientific and organisational work has been happily accomplished, but also for the outstanding quality of its content and for the absolute relevance of the theme. ICMI Study 23 fully realises the objectives of ICMI ‘to offer a forum for promoting reflection, collaboration and the exchange and dissemination of ideas on the teaching and learning of mathematics from primary to university level’. Concentrating on whole numbers in primary grades represents a relevant signal of interest for a crucial moment in educational programmes everywhere in the world. Never as in this case it is truer that the study addresses a theme of particular significance to contemporary mathematics education.

The content of the volume is in perfect consonance with the overall ICMI programmes, according to which ‘ICMI works to stimulate the creation, improvement and dissemination of recent research findings and of the available resources for instruction (e.g curricular materials, pedagogical methods, the appropriate use of technology, etc.). The objective is of providing links among educational researchers, curriculum designers, educational policy makers, teachers of mathematics, mathematicians, mathematics educators and others interested in mathematical education around the world’.

The people of this study have worked on a project that is challenging both scientifically and culturally: the topics in the chapters and in the panel reports of the book, the commentaries on them written by eminent scholars, and the two appendices face a large horizon of themes that go well beyond mathematics and show how focusing on the learning and teaching of whole numbers is an immensely demanding task that requires a wide range of competencies in addition to mathematics, from linguistics to ethnomathematics, to neuroscience and more. The processes according to which kids learn and elaborate whole numbers and their properties are incredibly rich and intermingled with the culture where they live and with which they can speak and think, as well as with the artefacts, which the tradition of their countries or the most recent technology allows them to use.

The book builds, in this sense, a real-world map of whole number arithmetic: even if it is far from being complete, it does cover many regions of the world, from East to West, from North to South, including many non-affluent countries. The contributions from the different cultures illustrate the fascinating enterprise of the mathematics teachers at the primary level, who from the one side speak the universal language of mathematics, but from the other side can link it to the specific language and cultural environment of their own countries, in order to make it accessible to their students. This amazing synthesis emerges clearly from the research and practice described in the volume, which has the not-common capacity of intertwining the rigour of mathematics, linguistics, cognitive sciences, etc. with the extraordinary different ways according to which numbers are alive in the different regions.

It is particularly significant that the study and the volume also had the contributions of invited people from another relevant IMU-ICMI programme, the ‘Capacity and Networking Project (CANP)’, aimed to enhance mathematics education at all levels in developing countries so that their people are capable of meeting the challenges these countries face. Their inputs have been important, since they emphasised the problems and the specificities of teaching whole numbers in those countries and contributed to the richness and variety of voices in the volume.

The 536 pages of the book demonstrate the incredibly intense work of this study, which lasted almost five years, from the appointment of the International Program Committee and its two co-chairs at the end of 2012, to the preparation and organisation of its Conference, which was held in Macao in June 2015, to the last intense work for the preparation and editing of this book, which, as it is usual for the ICMI Study volumes, does not consist of the proceedings of the meeting, but is a further elaboration of the discussions and results reached during the meeting itself.

I followed all these phases, and I must say that without the incredible work of the IPC and particularly of the two co-chairs, Profs. Maria G. Bartolini Bussi and Xu Hua Sun, we could not have now so nice a book, which is really a reference and a source of inspiration for theory, research and practice to all the community of researchers, practitioners and policymakers in mathematics education, especially, but not only, those interested in mathematical education at the primary level.

On behalf of the ICMI EC and of the ICMI larger family, I wish to thank all of them here for their remarkable work. As well, I take this opportunity to thank the University of Macau and the Education and Youth Affairs Bureau and especially its Rector Wei Zhao, Vice Rector Lionel Ni, Director Lai Leong, Dean Xitao Fan and Associate Dean Timothy Teo and Director of Global Affairs Da Hsuan Feng, who generously supported the organisation of the Conference; the President of the IMU, Prof. Shigefumi Mori, who attended the meeting in Macao, thereby underlining the relevance of this study for the community of mathematicians; and the Springer Publisher for its accurate work of editing.

Turin, Italy
December 31, 2016

Ferdinando Arzarello

ICMI Study 23: Primary Mathematics Study on Whole Numbers

Convenors:

Xu Hua Sun (University of Macau, Macao SAR, China)

Maria G. Bartolini Bussi (Università di Modena e Reggio Emilia, Italy)

International Program Committee:

Co-chairs: Maria G. Bartolini Bussi (Italy) and Xu Hua Sun (China)

Members:

Sybilla Beckmann (USA)

Sarah Inés González de Lora Sued
(República Dominicana)

Maitree Inprasitha (Thailand)

Berinderjeet Kaur (Singapore)

Joanne Mulligan (Australia)

Jarmila Novotná (Czech Republic)

Hamsa Venkat (South Africa)

Lieven Verschaffel (Belgium)

Abraham Arcavi (Israel – ICMI Secretary
General) ex officio

Roger Howe (USA – ICMI Liaison)

Ferdinando Arzarello (Italy – ICMI President)

Attendees at the Study Conference Held in Macao (SAR China) in June 2015

Abraham Arcavi	Maitree Inprasitha
Ferdinando Arzarello	Chunlian Jiang
Mike Askew	Min Jing
Nadia Azrou	Weerasuk Kanauan
Anna Baccaglioni-Frank	Berinderjeet Kaur
Deborah Loewenberg Ball	Visa Kim
Maria G. Bartolini Bussi	Qiping Kong
Hyman Bass	Ulrich Kortenkamp
Sybilla Beckmann	Pierre Kouamé Koffi
Aarnout Brombacher	Silke Ladel
Brian Butterworth	Caroline Lajoie
Christine Chambris	Kerstin Larsson
Narumon Changsri	Allen Leung
Limin Chen	Mongkolsery Lin
Kin Chung Cheung	Pi Jen Lin
King Fai Cheung	Liping Ma
Kwok-cheung Cheung	Lynn McGarvey
Alf Coles	Yaxuan Meng
Jason Cooper	Alain Jacques Mercier
Shelley Dole	Jasmina Milinković
Jean-Luc Dorier	Joanne Mulligan
Lisser Rye Ejersbo	Oi-Lam Ng
Anna-Lena Ekdahl	Yujing Ni
Adi Eraky	Jarmila Novotná
Ann M. Gervasoni	Andreas Obersteiner
Peter John Gould	Catherine Anne Pearn
Raisa Guberman	Andrea Peter-Koop
Shengqing He	Chanhpheng Phommaphasouk
Marja van den Heuvel-Panhuizen	Francisco Roberto Pinto Mattos
Annette Isabel Hilton	Serge Quilio
Catherine Houdement	Alessandro Ramploud

(continued)

Nicole (Nicky) Roberts	Lieven Verschaffel
Thomas Rottmann	Yanling Wang
Veronica Philemon Sarungi	Yi Wang
Judy M. Sayers	He Wei
Nathalie Sinclair	Shu Xie
G�rard Sensevy	Yan Ping Xin
Man Keung Siu	Mengling Xiong
Hannah Slovin	Yuriko Yamamoto Baldin
Sophie Soury-Lavergne	Der-Ching Yang
Xu Hua Sun	Jennifer Young-Loveridge
Fr�d�rick Tempier	Juan Zhang
Eva Thanheiser	Qiaoping Zhang
Estela Aurora Vallejo Vargas	Xiaoyan Zhao
Michiel Veldhuis	Dahai Zou
Linda Venenciano	Haode Zuo
Hamsa Venkat	Marianela Zumbado Castro

Contents

Part I Introductory Section

1	Building a Strong Foundation Concerning Whole Number Arithmetic in Primary Grades: Editorial Introduction	3
	Maria G. Bartolini Bussi and Xu Hua Sun	
2	Social and Cultural Contexts in the Teaching and Learning of Whole Number Arithmetic	19
	Maria G. Bartolini Bussi and Xu Hua Sun	
3	Language and Cultural Issues in the Teaching and Learning of WNA	35
	Xu Hua Sun and Maria G. Bartolini Bussi	
4	On Number Language: A Commentary on Chapter 3	71
	David Pimm	

Part II Working Group Chapters and Commentaries

5	The What and Why of Whole Number Arithmetic: Foundational Ideas from History, Language and Societal Changes	91
	Xu Hua Sun, Christine Chambris, Judy Sayers, Man Keung Siu, Jason Cooper, Jean-Luc Dorier, Sarah Inés González de Lora Sued, Eva Thanheiser, Nadia Azrou, Lynn McGarvey, Catherine Houdement, and Lisser Rye Ejersbo	
6	Reflecting on the What and Why of Whole Number Arithmetic: A Commentary on Chapter 5	125
	Roger Howe	

7	Whole Number Thinking, Learning and Development: Neuro-cognitive, Cognitive and Developmental Approaches	137
	Joanne Mulligan, Lieven Verschaffel, Anna Baccaglioni-Frank, Alf Coles, Peter Gould, Shengqing He, Yunpeng Ma, Jasmina Milinković, Andreas Obersteiner, Nicole Roberts, Nathalie Sinclair, Yanling Wang, Shu Xie, and Der-Ching Yang	
8	Whole Number Thinking, Learning and Development: A Commentary on Chapter 7	169
	Pearla Nesher	
9	Aspects that Affect Whole Number Learning: Cultural Artefacts and Mathematical Tasks	181
	Maria G. Bartolini Bussi, Maitree Inprasitha, Ferdinando Arzarello, Hyman Bass, Ulrich Kortenkamp, Silke Ladel, Caroline Lajoie, Yujing Ni, Thomas Rottmann, Veronica Sarungi, Sophie Soury-Lavergne, and Jenny Young-Loveridge	
10	Artefacts and Tasks in the Mathematical Preparation of Teachers of Elementary Arithmetic from a Mathematician’s Perspective: A Commentary on Chapter 9	227
	Bernard R. Hodgson	
11	How to Teach and Assess Whole Number Arithmetic: Some International Perspectives	251
	Jarmila Novotná, Berinderjeet Kaur, Ann Gervasoni, Mike Askew, Michiel Veldhuis, Catherine Pearn, and Xu Hua Sun	
12	How to Teach and Assess Whole Number Arithmetic: A Commentary on Chapter 11	287
	Claire Margolinas	
13	Connecting Whole Number Arithmetic Foundations to Other Parts of Mathematics: Structure and Structuring Activity	299
	Hamsa Venkat, Sybilla Beckmann, Kerstin Larsson, Yan Ping Xin, Alessandro Ramploud, and Limin Chen	
14	Structuring Structural Awareness: A Commentary on Chapter 13	325
	John Mason	
Part III Panels		
15	Tradition in Whole Number Arithmetic	343
	Ferdinando Arzarello, Nadia Azrou, Maria G. Bartolini Bussi, Sarah Inés González de Lora Sued, Xu Hua Sun, and Man Keung Siu	

16 Special Needs in Research and Instruction in Whole Number Arithmetic	375
Lieven Verschaffel, Anna Baccaglioni-Frank, Joanne Mulligan, Marja van den Heuvel-Panhuizen, Yan Ping Xin, and Brian Butterworth	
17 Professional Development Models for Whole Number Arithmetic in Primary Mathematics Teacher Education: A Cross-Cultural Overview	399
Jarmila Novotná, Maria G. Bartolini Bussi, Sybilla Beckmann, Maitree Inprasitha, Berinderjeet Kaur, Xu Hua Sun, Hamsa Venkat, and Mike Askew	
Part IV Plenary Presentations	
18 The Theory of School Arithmetic: Whole Numbers	439
Liping Ma and Cathy Kessel	
19 Quantities, Numbers, Number Names and the Real Number Line	465
Hyman Bass	
20 Low Numeracy: From Brain to Education	477
Brian Butterworth	
Appendices	489
Author Index	515
Subject Index	527

Contributors

Ferdinando Arzarello University of Turin, Turin, Italy

Mike Askew University of the Witwatersrand, Johannesburg, South Africa, and Monash University, Melbourne, Victoria, Australia

Nadia Azrou University Yahia Fares Medea, Medea, Algeria

Anna Baccaglini-Frank Università di Pisa, Pisa, Italy

Maria G. Bartolini Bussi Department of Education and Humanities, University of Modena and Reggio Emilia, Modena, Italy

Hyman Bass University of Michigan, Ann Arbor, MI, USA

Sybilla Beckmann University of Georgia, Athens, GA, USA

Brian Butterworth (discussant) University College London, London, UK

Christine Chambris Laboratoire de didactique André Revuz, Université de Cergy-Pontoise, Cergy, France

Limin Chen Shenyang Normal University, Shenyang, China

Alf Coles University of Bristol, Bristol, UK

Jason Cooper Weizmann Institute of Science, Rehovot, Israel

Sarah Inés González de Lora Sued Pontificia Universidad Católica Madre, Santiago de los Caballeros, República Dominicana

Jean-Luc Dorier University of Geneva, Geneva, Switzerland

Lisser Rye Ejersbo Aarhus University, Aarhus, Denmark

Ann Gervasoni Monash University, Melbourne, Victoria, Australia

Peter Gould NSW Department of Education and Communities, Sydney, NSW, Australia

- Shengqing He** Hangzhou Normal University, Hangzhou, China
- Bernard R. Hodgson** Université Laval, Quebec City, QC, Canada
- Catherine Houdement** Laboratoire de didactique André Revuz, Université de Rouen-Normandie, Rouen, France
- Roger Howe** Yale University, New Haven, CT, USA
- Maitree Inprasitha** Khon Kaen University, Khon Kaen, Thailand
- Berinderjeet Kaur** National Institute of Education, Nanyang Technological University, Singapore, Singapore
- Cathy Kessel** Consultant, Berkeley, CA, USA
- Ulrich Kortenkamp** Universität Potsdam, Potsdam, Germany
- Silke Ladel** Universität des Saarlandes, Saarbrücken, Germany
- Caroline Lajoie** Université du Québec à Montréal, Montreal, QC, Canada
- Kerstin Larsson** Stockholm University, Stockholm, Sweden
- Liping Ma** Independent Scholar, Shanghai, China, and Palo Alto, CA, USA
- Yunpeng Ma** Northeast Normal University, Changchun, China
- Claire Margolinas** Laboratoire ACTé, Université Clermont-Auvergne, Clermont-Ferrand, France
- John Mason** The Open University, Milton Keynes, UK
- Lynn McGarvey** University of Alberta, Edmonton, AB, Canada
- Jasmina Milinković** University of Belgrade, Belgrade, Serbia
- Joanne Mulligan** Macquarie University, Sydney, NSW, Australia
- Pearla Neshier** University of Haifa, Haifa, Israel
- Yujing Ni** Chinese University of Hong Kong, Hong Kong, China
- Jarmila Novotná** Charles University, Prague, Czech Republic, and Laboratoire “Culture et Diffusion des Savoirs”, Université de Bordeaux, Bordeaux, France
- Andreas Obersteiner** Technische Universität München, München, Germany
- Catherine Pearn** The University of Melbourne, Melbourne, Victoria, Australia
- David Pimm** Simon Fraser University, Burnaby, BC, Canada
- Alessandro Ramploud** Scuola Primaria Leopardi, Reggio Emilia, Italy
- Nicole Roberts** University of the Witwatersrand, Johannesburg, South Africa
- Thomas Rottmann** Bielefeld University, Bielefeld, Germany

Veronica Sarungi Institute for Educational Development, The Aga Khan University, Dar es Salaam, Tanzania

Judy Sayers Stockholm University, Stockholm, Sweden

Nathalie Sinclair Simon Fraser University, Burnaby, BC, Canada

Man Keung Siu (discussant) University of Hong Kong, Pokfulam, Hong Kong, China

Sophie Soury-Lavergne IFE ENS de Lyon, Lyon, France

Xu Hua Sun Faculty of Education, University of Macau, Macao, China

Eva Thanheiser Portland State University, Portland, OR, USA

Marja van den Heuvel-Panhuizen Utrecht University, Utrecht, the Netherlands

Michiel Veldhuis Utrecht University, Utrecht, The Netherlands

Hamsa Venkat University of the Witwatersrand, Johannesburg, South Africa

Lieven Verschaffel Katholieke Universiteit Leuven, Leuven, Belgium

Yanling Wang Northeast Normal University, Changchun, China

Shu Xie Northeast Normal University, Changchun, China

Yan Ping Xin Purdue University, West Lafayette, IN, USA

Der-Ching Yang National Chiayi University, Chiayi, Taiwan

Jenny Young-Loveridge University of Waikato, Hamilton, New Zealand

List of Abbreviations

ACARA	Australian Curriculum Assessment and Reporting Authority
AMPS	Awareness of Mathematical Pattern and Structure
ANS	Analogue Number System
APEC	Asia-Pacific Economic Cooperation
BCE	Before Common Era
CANP	Capacity and Networking Project
CCSSO	Council of Chief State School Officers
CE	Common Era
CERME	Congress of the European Society for Research in Mathematics Education
CFEM	Commission Française pour l'Enseignement des Mathématiques
CNAP	Catastro Nacional de Asentamientos en Condiciones de Pobreza
COMPS	Conceptual Model-based Problem Solving
CPA	Concrete–Pictorial–Abstract
CRME	Center for Research in Mathematics Education
CU	Composite Units
DAE	Digital Assessment Environment
DBE	Department for Basic Education
DOR	to Design – to Observe – to Redesign (a mathematics lesson)
DWR	Division With Remainder
DZ	Dizygotic
EASPD	European Association of Service Providers for Persons with Disabilities
EC	Executive Committee
EG	Equal Group
ENRP	Early Numeracy Research Project
ERMEL	Equipe de Recherche Mathématique à l'École Élémentaire
FASMED	Formative Assessment in Science and Mathematics Education
GCD	Greatest Common Divisor
ICD10	International Statistical Classification of Diseases and Related Health Problems 10th Revision

ICME	International Congress on Mathematical Education
ICMI	International Commission on Mathematical Instruction
ICMT	International Conference on Mathematics Textbook Research and Development
ICT	Information and Communication Technologies
IMU	International Mathematical Union
IPC	International Program Committee
IPST	Institute for the Promotion of Teaching Science and Technology
IQ	Intelligence Quotient
LAB	Linear Arithmetic Blocks
LCM	Least Common Multiple
LDM	Learning Disabilities (or Difficulties) in Mathematics
MAB	Multibase Arithmetic Blocks
MIUR	Ministero dell'Istruzione, dell'Università e della Ricerca
MLD	Mathematics Learning Difficulties
MOE	Ministry of Education
MOEST	Ministry of Education Science and Technology
MOEVT	Ministry of Education and Vocational Training
MPOS	Multiple Problems, One Solution
MSW NRW	Ministerium für Schule und Weiterbildung des Landes Nordrhein-Westfalen
MZ	Monozygotic
NCTM	National Council of Teachers of Mathematics
NGO	Non-Governmental Organisation
NLVM	National Library of Virtual Manipulatives
NRC	National Research Council
NSF	National Science Foundation
OECD	Organisation for Economic Co-operation and Development
OPMC	One Problem, Multiple Changes
OPMS	One Problem, Multiple Solutions
OTL	Opportunity to Learn
OTS	Object Tracking System
PASA	Pattern and Structure Assessment – early mathematics
PASMAP	Pattern and Structure Mathematics Awareness Program
PCK	Pedagogical Content Knowledge
PGBM	Please Go Bring Me
PISA	Programme for International Student Assessment
PME	(international group for the) Psychology of Mathematics Education
PVN	Place Value Notation
RME	Realistic Mathematics Education
SAT	Stanford Achievement Test
SBS	Social and Behavioural Science
SFON	Spontaneous Focusing on Numerosity
SFOR	Spontaneous Focusing on quantitative Relations
STEM	Science, Technology, Engineering and Mathematics

SYL	Sketchpad for Young Learners
TDI	Teacher-Delivered Instruction
TDS	Theory of Didactical Situations
TIMSS	Trends in International Mathematics and Science Study
UMI	Unione Matematica Italiana
UN	United Nations
UNESCO	United Nations Educational, Scientific and Cultural Organisation
UNICEF	United Nations International Children's Emergency Fund
UPE	Universal Primary Education
UR	Unit Rate
VT	Variation Theory
WMCP	Wits Maths Connect Primary
WNA	Whole Number Arithmetic
WOND	Wechsler Objective Numerical Dimension
WWYD	Watch What You Do

List of Figures

Fig. 1.1	The customised <i>suàn pán</i> for the participants in the conference	10
Fig. 3.1	The Chinese Rod representation of the first nine numerals	46
Fig. 3.2	Rod representation of multi-digit numbers	46
Fig. 3.3	An ancient drawing of a <i>suàn pán</i> (算盘) with measurement units	47
Fig. 3.4	The number 71,824, written by the mathematician Jia Xian during the Song dynasty (960–1279).....	50
Fig. 3.5	The oral counting in Chinese. One ones, two ones ...; ten ones, one ten and one ones, one ten and two ones, ...; two ten ones, two tens and one ones	50
Fig. 3.6	The decomposition of 6 in many different ways as $5 + 1$, $4 + 2$ and so on	51
Fig. 3.7	Addition in the Chinese textbook	52
Fig. 3.8	Subtraction in the Chinese textbook	54
Fig. 3.9	Representation of 123456789 in a Chinese <i>suàn pán</i>	55
Fig. 3.10	Wording on <i>suàn pán</i> : forward and backward	55
Fig. 3.11	Comparing numbers in the first grade.....	55
Fig. 3.12	Fingering in <i>suàn pán</i> : the correct method of moving the beads.....	60
Fig. 4.1	Dienes blocks	76
Fig. 4.2	A depiction of Dienes blocks	77
Fig. 4.3	An ancient Egyptian numeral.....	77
Fig. 4.4	(a–d) Various relationships among sets of number words within a single natural language	83
Fig. 4.5	Metaphor and metonymy in relation to the interlinked systems of natural language, notation and the world	85

Fig. 5.1	Shang oracle bone numerals from the fourteenth century BCE	101
Fig. 5.3	Representation of 4359	102
Fig. 5.4	Representation of 5080	102
Fig. 5.2	Representation of 1234 on a horizontal counting board	102
Fig. 7.1	Which is the largest set?.....	141
Fig. 7.2	The line begins at 0 and ends at 10. Where is the number 6 located?.....	141
Fig. 7.3	A possible decomposition of 7×3 in $5 \times 3 + 2 \times 3$	152
Fig. 8.1	Example elaborated by the author: exemplification according to Gattegno's approach to the additive relation.....	175
Fig. 9.1	Semiotic mediation	187
Fig. 9.2	The Ishango bone.....	189
Fig. 9.3	Tallies for ballot counts.....	189
Fig. 9.4	Chinese counting rods from excavation.....	190
Fig. 9.5	Chinese counting rods from Mekong area.....	190
Fig. 9.6	Counting rods from Conti (1920)	191
Fig. 9.7	An Inca <i>quipu</i> from the Larco Museum in Lima	191
Fig. 9.8	<i>Quipu</i> and <i>yupana</i> (By Felipe Guaman Poma de Ayala)	192
Fig. 9.9	Roman abacus	193
Fig. 9.10	A precious ancient jade <i>suàn pán</i> 算盘	193
Fig. 9.11	A <i>soroban</i>	193
Fig. 9.12	A <i>schoty</i>	193
Fig. 9.13	The arithmetic rack	194
Fig. 9.14	'Tavola pitagorica' from an Italian notebook.....	194
Fig. 9.15	The reduced pithy table from an old Chinese textbook	195
Fig. 9.16	<i>Left</i> : Napier's bones. <i>Right</i> : instruction	196
Fig. 9.17	Gelosia multiplication: $323 \times 12 = 3876$	196
Fig. 9.18	A <i>mancala</i>	197
Fig. 9.19	Playing cards.....	197
Fig. 9.20	A monochrome spike abacus	200
Fig. 9.21	An ancient Italian manuscript	201
Fig. 9.22	Place value chart and a foldable strip representing 5376; folded it shows the four-digit number; unfolded it shows the sum of thousands, hundreds, tens and ones	202
Fig. 9.23	A child jumping on a floor number line.....	203
Fig. 9.24	Moving Tweety on the number line	204
Fig. 9.25	Drawn arches on the number line	204
Fig. 9.26	A second grader draws two exemplars of spike abacus close to each other to represent an eight-digit number by juxtaposing them.....	206

Fig. 9.27	The drop-box game extracted from Inprasitha and Isoda	208
Fig. 9.28	Activity for first graders	208
Fig. 9.29	The pascaline (<i>left</i>) and the e-pascaline in a Cabri Elem e-book (<i>right</i>), both displaying number 122	210
Fig. 9.30	The tablet version of the e-pascaline	210
Fig. 9.31	TouchCounts	212
Fig. 9.32	Ladybug Count (<i>left</i>) and Fingu (<i>right</i>)	213
Fig. 9.33	<i>Stellenwerttafel</i>	213
Fig. 9.34	An image from a d-book with students' drawings	214
Fig. 9.35	Young children counting the beads of a giant Slavonic abacus	216
Fig. 9.36	A 3×3 grid square	218
Fig. 9.37	The calendar	218
Fig. 10.1	Numerosity of dots aggregates	233
Fig. 10.2	The factors of 18, <i>à la Cuisenaire</i>	234
Fig. 10.3	Passing from the square of a whole number to the next	235
Fig. 10.4	Fragment of the calculation of 23×15 (detailed style)	235
Fig. 10.5	The 'cargo method' of F. Lemay	240
Fig. 10.6	The 7-hour clock	243
Fig. 10.7	The six-column Eratosthenes sieve	243
Fig. 10.8	The Spirograph curve 105/30 and the star polygon $\{7/2\}$	245
Fig. 10.9	Visual proofs of basic rules of arithmetic	246
Fig. 11.1	Seating organisation	258
Fig. 11.2	Introduction and welcome	258
Fig. 11.3	Lead in: fluency with number facts	258
Fig. 11.4	First situation setting	259
Fig. 11.5	Second situation setting	259
Fig. 11.6	Third situation setting	259
Fig. 11.7	Group counting and sharing	260
Fig. 11.8	Practice stage 1	260
Fig. 11.9	Practice stage 2	260
Fig. 11.10	Practice stage 3	261
Fig. 11.11	Addition and subtraction growth point distribution for Grade 1–4 children	264
Fig. 11.12	Examples introducing the decomposition of 10 in the Chinese textbook	266
Fig. 11.13	Scheme of a didactical situation	273
Fig. 11.14	Representations on the whiteboard	274
Fig. 11.15	Representation of 24 and 9	274
Fig. 11.16	Candies in boxes	274
Fig. 11.17	Different representations of $24 + 9$	275

Fig. 12.1	Hamdi's representation of the square's problem.....	291
Fig. 12.2	Floriane's representation of the square's problem	292
Fig. 13.1	The child's hand.....	313
Fig. 13.2	The expression $N \times 2$	314
Fig. 13.3	Conceptual model of <i>equal groups</i> problems	315
Fig. 13.4	Conceptual model of <i>multiplicative compare</i> problems	315
Fig. 13.5	Conceptual model of <i>part-part-whole</i> problems.....	316
Fig. 13.6	Conceptual model of <i>additive compare</i> problems	316
Fig. 13.7	Reasoning about proportional relationships from a multiple-batches perspective	319
Fig. 13.8	Reasoning about proportional relationships from a variable-parts perspective.....	320
Fig. 14.1	A stick configuration.....	328
Fig. 14.2	A part of a frieze pattern	328
Fig. 15.1	The introduction of tens in the Chinese textbook	354
Fig. 15.2	The world's earliest decimal multiplication table	359
Fig. 15.3	Spike abacus with rods in a Chinese textbook.....	360
Fig. 15.4	Addition and subtraction with concept connection in a Chinese textbook.....	361
Fig. 15.5	From units to tens (the <i>left</i>) and thousands (the <i>right</i>) in the Chinese textbook.....	362
Fig. 15.6	Different number systems	365
Fig. 15.7	Extraction of the square root.....	367
Fig. 15.8	Problem of the square city and tree.....	367
Fig. 15.9	Extraction of the square root with accompanying number	368
Fig. 15.10	Setting up a quadratic equation in a geometric context	369
Fig. 16.1	Percentage problem in the DAE with optional auxiliary tools.....	387
Fig. 16.2	Sample screenshots of the PGBM-COMPS© intelligent tutor system.....	390
Fig. 17.1	Using a definition of multiplication and a strip diagram to explain an equation	406
Fig. 17.2	Use of models to solve a two-part word problem	408
Fig. 17.3	Implicit introduction of the part-part-whole concept in Grade 1	409
Fig. 17.4	Explicit introduction of part-part-whole models in Grade 2.....	410
Fig. 17.5	Lesson study incorporating open approach.....	415
Fig. 17.6	Contents and steps for teaching $9 + 4$	416
Fig. 17.7	Students' responses for $9 + 4$	417

Fig. 18.1	The definition of unit	442
Fig. 18.2	The definition of sum of two numbers	445
Fig. 18.3	Example of introducing definition and terms of addition to first-grade students	447
Fig. 18.4	Two stages in first-grade subtraction	449
Fig. 18.5	The correspondence between terms in addition and subtraction	449
Fig. 18.6	Addition and subtraction derived from the quantitative relationship ‘sum of two numbers’; terms used in addition and subtraction	451
Fig. 18.7	Example of ‘equivalent substitution’ in ‘sum of two numbers’	452
Fig. 18.8	The definition of product of two numbers	453
Fig. 18.9	The correspondence between terms in multiplication and division	456
Fig. 18.10	Multiplication, partitive and quotitive divisions	457
Fig. 19.1	Exercises from Davydov’s curriculum	471
Fig. 19.2	Making bundles	474
Fig. 20.1	Voxel-based morphometry (structural brain imaging) identifies a <i>left</i> parietal cluster that correlates with core number skill	483
Fig. 20.2	Dots2Track	485

List of Tables

Table 2.1	The context form	23
Table 2.2	The countries	25
Table 2.3	Structure of primary school.....	27
Table 3.1	The symmetric scheme in <i>Sunzi Suanjing</i>	56
Table 3.2	The frequency of teaching with variation in the Chinese classroom.....	58
Table 3.3	An example of variation problems from the OPMC category Beijing Education Science Research Institute and Beijing Instruction Research Center for Basic Education (1996), vol. 4, p. 88.....	65
Table 9.1	Four-Phases_Model to support the development of basic computational ideas	206
Table 9.2	Levels of cognitive demands	215
Table 9.3	Number ranges within grades 1–4.....	219
Table 11.1	Setting and sequence of activities of the lesson	256
Table 11.2	The lesson plan (excerpt)	267
Table 14.1	A grid	330
Table 15.1	Some pre-Columbian names of numbers	357
Table 17.1	International comparison.....	423
Table 17.2	Summary of experiments	425
Table 20.1	Three-digit subtraction, three-digit multiplication and three-digit division accuracy at age 10–11 years	482
Table 20.2	Heritability of arithmetic and dot enumeration.....	483

Part I
Introductory Section

Chapter 1

Building a Strong Foundation Concerning Whole Number Arithmetic in Primary Grades: Editorial Introduction



Maria G. Bartolini Bussi  and Xu Hua Sun 

Il ne s'agit pas là de philosophie comparée, par mise en parallèle des conceptions; mais d'un dialogue philosophique, où chaque pensée, à la rencontre de l'autre, s'interroge sur son impensé

(‘This is not about comparative philosophy, about paralleling different conceptions, but about a philosophical dialogue in which every thought, when coming towards the other, questions itself about its own unthought’ (Jullien 2006, p. vi))

他山之石, 可以攻玉 (*tā shān zhī shí, kěyǐ gōng yù*)
(‘The stone from another mountain can be used to polish one’s own jade’ (Xiao Ya, Shijing: He Ming, 1000 A. C.))

1.1 Introduction

After more than five years of collaboration on whole number arithmetic (WNA), we summarise our experiences, focusing on the process, the merits and the limits of the ICMI Study 23, together with the potential for future activity and for addressing different kinds of audience. We have not worked alone. A very knowledgeable and helpful International Program Committee (IPC) shared the whole process of preparation of this volume. We wish to thank them all for their long-lasting (and not yet finished) collaboration; although, obviously, the responsibility for some delicate choices and possible mistakes and misunderstandings is left to the two of us.

The second author was supported by Research Committee, University of Macau, Macao, China (MYRG2015-00203-FED). The opinions expressed in the article are those of the authors.

M.G. Bartolini Bussi (✉)

Department of Education and Humanities, University of Modena and Reggio Emilia,
Modena, Italy

e-mail: mariagiuseppina.bartolini@unimore.it

X.H. Sun (✉)

Faculty of Education, University of Macau, Macao, China

e-mail: xhsun@umac.mo

© The Author(s) 2018

M.G. Bartolini Bussi, X.H. Sun (eds.), *Building the Foundation: Whole Numbers in the Primary Grades*, New ICMI Study Series,
https://doi.org/10.1007/978-3-319-63555-2_1

The two epigraphs above, from the French philosopher and sinologist François Jullien and from an ancient Chinese saying, summarise our attitude now. This international study has offered us the opportunity to increase our knowledge and start two complementary processes:

- Becoming aware of some deep values of our own culture (our ‘unthought’) which we may have considered in the past the only possible choice or, at least, the most suitable choice for an ideal ‘human nature’.
- Considering the possibility of introducing into our own practices, beliefs and values (our ‘jade stone’) the processes of innovation, not copied from but influenced by practices, beliefs and values of another culture.

The Study Volume is an account of the collective memory of participants offered to the wider community of primary mathematics educators, including researchers, teachers, teacher educators and policymakers. It is a product of fruitful collaboration between mathematicians and mathematics educators, in which, for the first time in the history of ICMI, the largely neglected issue of WNA in primary school has been addressed. The volume reports all the activities of the Conference. Many co-authors, who were involved in a collective co-authorship, are listed at the end of the volume.

1.2 The ICMI Study 23

1.2.1 *The Rationale of the Study*

Primary schooling is compulsory in all countries, with different facilities and opportunities for children to take advantage of it. Mathematics is a central subject in primary mathematics education, and the delivery of the mathematics curriculum is important in all countries for the different kinds of citizens and the different kinds of competences each seeks to produce. In the proceedings of a recent workshop organised by the National Academies of Science, Engineering and Medicine, held in November 2016, to explore the presence and the public perception of the Social and Behavioural Science (SBS) in K-12 education, a research survey was conducted that compared public knowledge and attitudes towards the natural sciences and social sciences, using a representative national sample of 1000 adults (balanced in terms of age and gender). Besides questions on SBS, the survey included questions about STEM (Science, Technology, Engineering and Mathematics). More than 30% of respondents opined that mathematics and science education should begin in elementary school or earlier with a strong preference for mathematics in both pre-school and elementary school.¹

¹ <http://nap.us4.list-manage.com/track/click?u=eaea39b6442dc4e0d08e6aa4a&id=99397b4537&e=f0cb5232c5>

WNA and related concepts form the basis of mathematics content covered in later grades. WNA in primary school lays the foundation for secondary school. It is one of the goals of education for all and a part of the UN Global Education First Initiative (UNESCO 2012). Consistently, the volume titled *Building the Foundation: Whole Numbers in the Primary Grades* aims to convey the message of the importance of laying a solid foundation of WNA as early as possible for further mathematics learning.

1.2.2 *The Launch of the Study*

A reflection on primary school mathematics was considered timely by the ICMI Executive Committee (EC) (term 2010–2012). The theme of the study was defined as follows:

The beginning of the approach to whole numbers, including operations and relations, and the solution of arithmetic word problems, in schools (and possibly pre-school environments), up to Grade 3 or more, according to the various education systems

Although it is not the only topic relevant to primary school mathematics, WNA was chosen by the EC of ICMI to focus on a shared centrality in primary school mathematics curricula all over the world.

The study was launched by ICMI at the end of 2012, with the appointment of two co-chairs and the IPC, which, on behalf of ICMI, was responsible for conducting the study:

Maria (Mariolina) G. Bartolini Bussi, Italy, and Xu Hua Sun, Macao SAR, China (co-chairs);

Berinderjeet Kaur, Singapore; Hamsa Venkat, South Africa; Jarmila Novotná, Czech Republic; Joanne Mulligan, Australia; Lieven Verschaffel, Belgium; Maitree Inprasitha, Thailand; Sybilla Beckmann, USA; Sarah Inés González de Lora Sued, Dominican Republic; Abraham Arcavi, Israel (ICMI Secretary General); Ferdinando Arzarello, Italy (ICMI President); Roger E. Howe, USA (ICMI liaison)

1.2.3 *The Discussion Document*

During 2013, an intense mail exchange within the IPC established and shared the rationale, the goals and the steps of the forthcoming study. In January 2014, an IPC meeting took place in Berlin, at the IMU Secretariat, which generously supported the costs. The IPC members were welcomed by Prof. Dr. Jurgen Sprekels, Director of the Weierstrass Institute for Applied Analysis and Stochastic (WIAS, Berlin), and by the then ICMI President Prof. Ferdinando Arzarello, who participated in the meeting and, later, in the entire Study Conference.

The meeting in Berlin took place in a productive and collaborative atmosphere.

A Discussion Document (this volume, Appendix 2) including a call for papers for the Study Conference was prepared, with the Study Conference announced for June 2015 in Macao (SAR China). This document summarised issues that were considered important to discuss in the study. Emphasis was given to the importance of cultural diversity and its effects on the early introduction of whole numbers. In order to foster understanding of the different contexts in which authors had developed their studies, each applicant for the study was required to fill a specific *context form* in order to include background information about their submission's context (this volume, Chap. 2).

Five themes (each corresponding to a working group in the Conference) were identified and assigned to pairs of members of the IPC:

1. *The why and what of whole number arithmetic*
2. *Whole number thinking, learning and development*
3. *Aspects that affect whole number learning*
4. *How to teach and assess whole number arithmetic*
5. *Whole numbers and connections with other parts of mathematics*

Three plenary panels were identified:

1. *Traditions in whole number arithmetic*, chaired by Ferdinando Arzarello
2. *Special needs in research and instruction in whole number arithmetic (WNA)*, chaired by Lieven Verschaffel
3. *Whole number arithmetic and teacher education*, chaired by Jarmila Novotná

Three plenary speakers were invited: Hyman Bass, Brian Butterworth and Liping Ma.

The intention of the IPC was to offer a map of some important issues related to WNA, crossing the borders of countries and regions. The aim was to foster reflections among participants (and, subsequently, among the readers of the volume) on their own cultural contexts, with representation in the Conference and the volume of sources from a wide range of geographical and socio-economic contexts. Cole's (1998) book on *Cultural Psychology* affirms the need for this kind of range:

In recent decades many scholars whose work I discuss have sought to make the case for a culture-inclusive psychology. They argue that so long as one does not evaluate the possible cultural variability of the psychological processes one studies, it is impossible to know whether such processes are universal or specific to particular cultural circumstances. For examples, John and Beatrice Whiting, anthropologists with a long-term interest in human development, wrote: 'If children are studied within the confines of a single culture, many events are taken as natural, or a part of human nature, and are therefore not considered as variables. It is only when it is discovered that other people do not follow these practices that have been attributed to human nature that they are adopted as legitimate variables'. (p. 2)

The temptation of a narrow and local perspective is a risk for mathematics educators too, given the enormous advantages that mathematics developed in the West in recent centuries has had on the development of science, engineering and technologies. This study aimed at challenging some of these beliefs with a short, yet lively, immersion in an atmosphere where a more open mind is needed, at least when

discussing early year mathematics and where the strong links with everyday life and cultural traditions come into play.

1.2.4 *The Study Conference*

By the end of the selection process, 67 papers were accepted and distributed over the five themes. For each accepted paper, a maximum of two co-authors were invited to participate in the Study Conference. A volume of proceedings was edited by Xu Hua Sun, Berinderjeet Kaur and Jarmila Novotná (Sun et al. 2015).

Thanks to generous support from the University of Macau, the Education and Youth Affairs Bureau, Macao SAR and ICMI, for the first time the ICMI Study 23 was able to invite observers from developing countries. A choice was made to privilege *Capacity and Networking Project (CANP)* participants who comprise the major developmental focus of the international bodies of mathematicians and mathematics educators (this volume, [Appendix 1](#)). Other observers came from the Great Mekong Area and China. The total number of participants was 91 from 23 countries.

The Study Conference was held on June 3–7, 2015, in Hengqin Campus, University of Macau, leased to Macao by the State Council of the People's Republic of China in 2009 for the construction of the new campus. The Conference was opened by Prof. Zhao Wei, Rector of the University of Macau. Addresses were given by Mr. Wong Kin Mou, Representative of Director of the Education and Youth Affairs Bureau and Chief of Department of Research and Educational Resources of Macao SAR; Prof. Shigefumi Mori, President of IMU; Prof. Ferdinando Arzarello, President of ICMI; and the co-chairs (the co-authors of this chapter).²

1.2.5 *The Study Volume*

The ICMI Study Conference served as the basis for the production of this Study Volume, edited by the two co-chairs of the study. The five themes identified in the Discussion Document (this volume, [Appendix 2](#)) were assigned to pairs of members of the IPC, who took part in the selection of the submitted papers and the organisation of the five working groups in the conference. As is the tradition with the ICMI studies, the IPC members who led the working groups proceeded to lead the writing of the corresponding chapter and to synthesise and integrate the papers presented in the group alongside the subsequent discussions. Unfortunately, due to health reasons, Sarah Inés Gonzáles de Lora Sued was not able to take part in the Conference. During the writing process, Christine Chambris kindly accepted to take Sarah's role.

²A gallery of photos from the Study Conference is available at: www.umac.mo/fed/ICMI23/photo.html.

A short summary of the volume follows.

The introductory part addresses some background issues.

The diversity of contexts (Chap. 2) addresses the growing importance of understanding the role of the social and cultural context in which the teaching and learning of mathematics is situated. The process that led the IPC to prepare a *context form* for each submitted paper is reported, together with a short analysis of the collected forms. This information is important to understand the perceptions of the contributors involved in writing this volume.

The diversity of languages (Chap. 3) addresses a feature that emerged in working groups and plenary panels as well. The richness of cultural contexts allowed participants to discuss possible linguistic supports or limitations that may interfere with students' mathematics learning and teacher education. The participants were informed by the working group leaders (when appropriate) that their contribution to the language discussion would have been summarised in an editorial chapter by the co-chairs, mentioning their contribution in the proceedings. A large part of the chapter is devoted to the Chinese case that is different from many other languages.

Chapter 4 is a commentary paper prepared by an acknowledged scholar in the field, David Pimm. He was not able to participate in the Conference, but was kindly willing to write a commentary chapter.

The working groups' part comprises 10 chapters, organised in pairs. The working groups' chapters are co-authored by the IPC members who led the group together with listed participants, and the different levels of collaboration during the writing process are acknowledged as mutually agreed. The odd-numbered chapters (Chaps. 5, 7, 9, 11 and 13) report, in order, the outputs of the discussions of the five working groups. Each of these chapters is followed (in the even-numbered chapters) by a commentary paper authored by an acknowledged scholar with expertise in the field of whole number arithmetic, who did not take part in the Conference and thus offered a different perspective on the study's key themes: Roger Howe (Chap. 6), Pearla Neshet (Chap. 8), Bernard Hodgson (Chap. 10), Claire Margolinas (Chap. 12) and John Mason (Chap. 14).

The panel part includes three panels (Chaps. 15, 16 and 17), which aimed to address some transversal issues (traditions, special needs and teacher education) that cut across the working group foci, with the participation of most members of the IPC exploiting their areas of expertise and of some other invited participants, including a discussant for each panel.

The plenary presentation part includes three plenary presentations (Chaps. 18, 19 and 20) which aimed at addressing WNA from three different perspectives: that of a professional mathematician and past ICMI president (Hyman Bass), that of a neurocognitive scientist with research on developmental dyscalculia (Brian Butterworth) and that of a scholar in mathematics education with expert knowledge of Chinese and US traditions (Liping Ma).

Three appendixes are included in the volume – the first related to the CANP participants' reflections, the second related to the Discussion Document of the ICMI Study 23 and the third related to the electronic supplementary material (videos).

1.3 Merits of the Study

The ICMI Study 23 has seen merits from both organisational and scientific perspectives.

The Study Conference was located in Macao SAR, the right place for many reasons. First, in recent years, the outstanding performance of Chinese students in the OECD PISA mathematics assessment was debated all over the world. In particular, Macao SAR's performance rose from 15th position in 2009 to 3rd position in 2015. Knowing more about this performance is of interest to all mathematics educators.

But there are other reasons. Macao is known as the place of a dialogue between Portugal and China, between European and Eastern cultures. Contacts between Asia and the West started along the Silk Road even before the Common era (BCE).³ As from the thirteenth century, numerous traders – most famously the Italian Marco Polo – had travelled between Eastern and Western Eurasia. In the sixteenth century (1552), St Francis Xavier, a Navarrese priest and missionary and co-founding member of the Society of Jesus, reached China. Some decades later, the Italian Jesuit Matteo Ricci reached Macao. He introduced Western science, mathematics, astronomy and visual arts into China and carried on significant intercultural and philosophical dialogue with Chinese scholars, particularly representatives of Confucianism.

Matteo Ricci (1552–1610) is known as the initiator of the Catholic missions in China and one of the earliest members of the Society of Jesus. Others before him ventured towards China, but did not succeed in remaining there for life, let alone to receive the respect and admiration from the Chinese people that Ricci enjoys even to this day. The root of Ricci's success lies in his achieved integration as a human person that made it possible for him to enter so fully into another culture without losing himself. The Society of Jesus and Macao, in many ways, share together a common beginning and 450 years of history. The Jesuits in Macao have always been at the service of the human person, either in need of education or material help, but always at the very deepest level of ideals and hopes, where culture finds its roots. This Jesuit tradition continues even today in Macao at the Macao Ricci Institute.⁴

The Ricci Institute was visited by the participants in the Study as a part of the social programme, with lectures by Man Keung Siu about the role of Matteo Ricci in introducing elements of European mathematics into China. Among these were the first six books of *Euclid's Elements* and the first arithmetic book on European pen calculation. These translations changed Chinese mathematics education and gave Chinese people their first access to real images of Western mathematics (Chap. 15).

This intercultural dialogue is evident not only in the architecture of the old city, the parallel entrance corridor of the Macao museum⁵ and the road signs (written in Chinese and Portuguese), but also on the new Hengqin Campus,⁶ where the Study

³ www.ancient.eu/Silk_Road/

⁴ www.ricci-macao.org/eng/introduction/index.htm

⁵ www.macaumuseum.gov.mo/w3ENG/w3MMabout/MuseumC.aspx

⁶ www.umac.mo/about-um/introduction/about-the-university-of-macao.html

Fig. 1.1 The customised *suàn pán* for the participants in the conference



Conference was held. Hence, the participants were physically embedded in intercultural dialogue. We believe that this heritage of mixed traditions under the influence of the Confucian educational heritage can provide a resource for new thinking in global mathematics education development. In all the working groups and the panels, the discussion was lively, and the presence of the Chinese culture was evident: the colleagues from the Chinese areas discussed their own perspectives, often different from the others' and still connected with the classical tradition. Interestingly, a special gift was offered to all participants: a *suàn pán* (算盘), the famous Chinese abacus, added in 2013 to UNESCO's intangible heritage list (see Fig. 1.1).

A central part of the social programme was the visit to two first grade classrooms to observe lessons on addition and subtraction, according to the typical Chinese tradition of *open classes* (*guānmó kè*, 观摩课), where many observers (several dozens in our case) observed a lesson, with a carefully organised teaching plan distributed in advance, and discussed with the teachers later in order to improve the lesson for the future. The participants showed great interest in this lively observation of a Chinese classroom, it is described at length in one chapter of the Study Volume (Chap. 11), and commented on from a Western perspective (Chap. 12). The immersion in a culture so different from that of most participants led to a sharing of some features of a range of different traditions, providing a much broader and deeper airing of what is known in the literature. Comparisons between Chinese and Western cultures of education have become relatively common in the international literature (e.g. Gardner 1989; Stevenson and Stigler 1992), but most participants at the Study Conference had never had personal experience in this field. The meeting of different *cultural traditions* was reconsidered in a specific panel chaired by Ferdinando Arzarello (Chap. 15).

An innovation related to our central attention to culture was that during the Study Conference, in some working groups, short *video clips* about classroom episodes were shown by the participants, who had agreed to prepare them with English subtitles. The vivid impression that a video clip can give of classroom life and of the implicit culture is different from what is discernible in a written paper. While access to video clips was constrained by the need to meet permission, privacy and ethical rules (where these too are culturally dependent on different countries' laws and

norms), and by the resources available to prepare the English transcripts required to make the video clips understandable in the context of an international conference, we collected a small gallery of video clips that can be enlarged in the future. References to particular video clips appear across the volume as electronic supplementary material (see also [Appendix 3](#)) and are available on the publisher website.

Our attention to *contexts* and different cultural traditions is one of the major merits of this study, in place from the beginning in the Discussion Document (this volume, [Appendix 2](#)). It is worth noting our increased emphasis on what previously was considered more as a ‘special interest’ rather than a core feature: for instance, a plenary panel on *Cultural contexts for European research and design practices in mathematics education* (Jaworski et al. 2015) was hosted by CERME 9 (the Conference of the European Society for Research on Mathematics Education, held in Prague in 2015) and a plenary address was given by Bill Barton on *Mathematics education and culture: a contemporary moral imperative* at ICME 13.⁷ The direction seems to be right but the way remains long.

The issue of *languages* and their influence on WNAs was considered in different working groups and was summarised in a specific chapter (Chap. 3). Perspectives on WNA in relation to history, language and societal changes were also discussed in Chap. 5 and Chap. 6.

During the process, the IPC felt that the traditional limits on how WNA is perceived did not afford adequate recognition to the *connections* existing between different mathematical areas, for instance, the connection between arithmetic and algebra. Two chapters (Chaps. 13 and 14) address this issue.

Teacher education and development in relation to WNA was addressed in a panel (Chap. 17), complementing the ICMI Study 15 (Even and Ball 2009), thereby filling a gap in that the earlier study made little reference to primary level in the Study Volume.

Special needs were addressed in a panel (Chap. 16) that drew on the contribution of Chap. 7, reporting on neurocognitive, cognitive and developmental approaches. It represents a first step into a desirable and better dialogue between scholars from different communities, that is mathematics educators and (neuro-)cognitive scientists. WNA has been a hot topic in the field of psychology. Yet, studies carried out from the perspective of classroom teaching are relatively rare, and most studies are conducted in experiment rooms, with risks of limited application to classroom teaching and instruction. This study has thus started to build important discussions.

The issue of *early childhood* settings is considered in the chapters focusing on observation studies (Chap. 7) and intervention studies (Chap. 9). The importance of supporting literacy in these early childhood settings is widely accepted; but, historically, mathematics has often been viewed by many as unimportant to, or developmentally inappropriate for, young children’s learning experiences: for example, current US state standards for early childhood do not include much mathematics (National Research Council 2009). More generally, many early childhood pro-

⁷<https://lecture2go.uni-hamburg.de/l2go/-/get/v/19757>

grammes spend little focused time on mathematics and are accompanied by concerns of low instructional quality. Many opportunities are therefore missed for learning mathematics. A key exception is represented by the proactive stance of the European Society for Research in Mathematics Education, which has, from 2009, included a specific working group on *Early Years Mathematics* meeting every second year (Levenson et al. [in preparation](#)). A plenary talk on *Towards a more comprehensive model of children's number sense* by Lieven Verschaffel, member of the IPC of the ICMI Study 23, was also presented at CERME 10⁸ in Dublin.

Last but not least, a further merit of the Study is the involvement of *CANP representatives* as observers. This group has acknowledged ([Appendix 1](#)) the importance of the Study Conference where each of them was assigned to a working group, ensuring dialogue between them and the other participants. They also had a formal meeting with the ICMI President, Ferdinando Arzarello, during which, for the first time, experiences across CANPs were shared. Veronica Sarungi (personal communication), representative of CANP4, noted in her reflections:

One of the major contributions of the ICMI Study 23 was to enable the CANPs to build networks beyond their regions. As a result of connections formed in Macao, a discussion group proposal was submitted and accepted for ICME-13 that will focus on CANPs. Apart from networking, the meeting in Macao enhanced the individual capacity of the representatives that had an effect on their respective institutions, national and regional associations.

This friendly and supported introduction into the international community of mathematics educators has already contributed to broadened participation in other ICMI activities and regional conferences and meetings of affiliated organisations such as CERME.

1.4 Impact of the Study

Overall, the impact of the study is promising. Some communities indicated their interest before the Study Conference (e.g. Bartolini Bussi and Sun [2014](#); Beckmann [2015](#)). After the Conference, reports (by invitation) have appeared in key journals (*European Mathematical Society Newsletter*, in English; *Mathematics Education Journal*, in Chinese; the *Bulletin of CFEM*, in French) and conference proceedings (*Copirelem*, Bartolini Bussi and Sun [2015](#); *SEMT 2015*, Novotná [2015](#)). An official report has been published by *L'Enseignement Mathématique* (Bartolini Bussi and Sun [2016](#)). A report on “ICMI Study 23 on Whole Number Arithmetic” was given by Roger Howe at NCTM [2017](#). A presentation of the Study Volume was also held in 2016 in a special timeslot at ICME 13 in Hamburg.⁹

The intercultural dialogue between mathematics educators interested in WNA for the primary school continues in international conferences (such as SEMT, taking

⁸ www.cerme10.org

⁹ <https://lecture2go.uni-hamburg.de/l2go/-/get/v/19768>

place every second year in Prague¹⁰) and at ICME, where specific groups are organised every fourth year. Moreover, the Inter-American Conference on Mathematics Education (IACME), taking place every 4 years, has a special section on primary mathematics education, and WNA is an important part of it.

1.5 Limits of the Study

The aim of constructing a map of the main educational aspects of WNA has been partially fulfilled in the Study Conference and in this Volume, with a wide multicultural approach. Some themes have been deepened and some others have been opened up as new avenues that currently are simply sketched.

The issue of *textbooks* within the teaching of WNA is touched upon in some of the chapters (Chaps. 9 and 11), but would deserve a whole study in its own (Jones et al. 2014¹¹).

The issue of *assessment* of and for WNA learning too has been touched (Chap. 11), but the theme deserves further exploration. The ICMI Study 6 on assessment is as yet not updated (Niss 1993a, b) with changes internationally influencing practices at the country and classroom levels (see, for instance, Suurtamm et al. 2016).

The issue of *gifted students' needs* was only skimmed within the consideration of challenging mathematical tasks (Chaps. 9, 10 and 14). Hence, in this case too, there is space for further development (see, for instance, Singer et al. 2016).

The participation in the Study Conference deserves some comments. It was not surprising that China was well represented in the Conference, because of the proximity to the venue. Yet, in spite of the significant efforts of the IPC members, a limitation of the study was the failure to involve mathematics educators from a wider range of countries and regions (e.g. Russia, India, Japan, Korea, several parts of Africa and Latin America). Equity imperatives for participation in the ICMI Study 23 therefore remained far from being reached, although the themes of the Study had the potential to involve mathematics educators and policymakers from developing countries. Key obstacles that we identified included:

- Ineffective dissemination (international mailing lists and journals continue to reach a limited portion of the mathematics education community across the world).
- Language issues (the choice of English as the study language, although inescapable, may well have inhibited some authors from applying).
- Costs (while airfares tend not to be strictly related to the distance from countries, commercial constraints continue to apply).

¹⁰ www.semt.cz

¹¹ www.sbm.org.br/icmt2/

1.6 The Implications of This Study

1.6.1 *A Message for Practitioners*

The multifaceted aspects considered in the many chapters of the Study Volume have the potential to attract mathematics teachers and teacher educators from all over the world: there are collections of tasks, activities and artefacts (see, for instance, Chaps. 9 and 10), addressing WNA. Approaches and models for teacher education and development are also broadly represented in the study, with input from many acknowledged scholars in the field of mathematics education, making the study attractive for researchers in primary school arithmetic.

From the many examples, we pick up some:

- Balancing ordinal, cardinal and measurement aspects of (and approaches to) number sense.
- Connecting the three core concepts of addition, subtraction and number together.
- Exploiting the potential of cultural artefacts (e.g. abaci, Dienes blocks, Cuisenaire rods, pascalines, devices from multitouch technologies).
- Focusing on structural approaches to early number development.
- Focusing on the make-a-ten method of addition and subtraction within 20.
- Storytelling to borrow the completely regular number names in those cultures where irregular names are present.
- Emphasising the importance of figural and spatial representations.
- Fostering bodily involvement such as counting with fingers, dancing or jumping on the number line.

1.6.2 *A Message for Curriculum Developers and Policymakers*

The attention to the social and cultural contexts and to the importance of native languages in mathematics learning has the potential to attract curriculum developers and policymakers. Around the world, 250 million children either fail to complete more than 3 years of basic education or lack basic numeracy skills for ongoing learning despite finishing 3 years of basic education (Matar et al. 2013). In one region of Morocco, one assessment showed that 20% of Grade 2 students could not solve any simple addition problems and 44% could not answer any simple subtraction problems (Matar et al. 2013). Furthermore, children who start school with a poorly developed understanding of number tend to remain low achievers throughout school (Geary 2013). This contrast between acknowledged needs and existing instructional programmes should be a major preoccupation of curriculum developers and policymakers.

Some policies and approaches that this study offers as suggestions include:

- Taking seriously the influence of early grade instruction on success in later education.
- Promoting early childhood mathematics in schools.
- Considering globalisation and the roots of mathematics in local cultures in a dialectic way.
- Taking the particular language and cultural constraints into account.
- Addressing the use of cultural artefacts and cognitively demanding tasks as teaching aids.
- Acknowledging the professional status of primary school teachers.
- Designing primary teacher education and development in order to make them highly educated professionals.

1.7 Concluding Remarks

Our hope is that the special focus on WNA in primary school mathematics within ICMI Study 23 lays the ground for further attention to primary mathematics topics, curricula and pedagogies to be addressed in future studies and in the conferences of organisations affiliated to ICMI, because *building the foundation*, as the title of volume reads, is critically important for the development of mathematics teaching and learning in secondary/high schools and beyond.

The interest shown by the participants from many different countries and regions and their engagement in authoring parts of this volume, as well as the early impact of the study, suggest strong potential and opportunities for organising a follow-up study in a few years' time. We, as co-chairs of the ICMI Study 23, will continue to collaborate in order to ensure a long-lasting influence of this study in our regions and, more generally, at the international level.

ICMI conferences and studies are examples of attempts to improve communication between different communities. However, it is misleading to claim that ICMI Study 23 achieved a *shared perspective*. This volume does not present a single coherent discourse, nor did the mathematics educators and the mathematicians converge to a common discourse of teaching WNA. A better description would be *sharing perspectives*, in the following sense: the various communities were given ample opportunities to present and elaborate their perspectives; others listened attentively and respectfully; there were opportunities for participants to discuss commonalities and differences and to develop new insights, yet eventually each participant was free to adopt, reject, modify or integrate parts of the others' perspectives into his/her own discourse of WNA.

In a world increasingly driven by questions about borders and migrations across them, what this volume has succeeded in collecting are overviews and discussions that are of interest to mathematics educators across phases and across borders. The volume provides illustrations of interventions and developments that share, across

different cultural contexts, a concern with broadening access to foundational mathematical ideas that are important if we are to contribute to progress and participation into higher-level mathematics. Diversity of language, artefacts and approaches to this endeavour of broadening access strengthens the field's ability to address this goal. We conclude by offering our thanks for the cross-cultural interaction processes that have culminated in this work. The broader global discourses that prevail at the time of the publication of this volume resonate with talk of walls and of borders. This volume stands as a testament to the strength of cross-national and cross-cultural collaboration – the dissolution of borders – and this study, like previous ICMI studies, is enriched by the international collaboration.

1.8 Processes and Acknowledgements

The chapters were reviewed internally by the IPC and by the co-chairs. Through this process, cross-referencing was developed as much as possible, and there was careful examination of any overlaps. Where different chapters have treated similar ideas, we have tried as far as possible to indicate cross-references.

We want to acknowledge the particular roles played by three members of the IPC, Xu Hua Sun, Jarmila Novotná and Berinderjeet Kaur, who carefully edited the online proceedings (Sun et al. 2015), and the role played by Hamsa Venkat, who was helpful in editing many chapters of the volume. Xu Hua Sun, as a Macao co-convenor, took care of many financial and practical matters, which made the study possible. We are also grateful to Bill Barton who, as President of ICMI when the proposal was submitted, was encouraging and supportive; Lena Koch who managed many ICMI matters; Ferdinando Arzarello, the President of ICMI; and to Abraham Arcavi, the ICMI Secretary General, during the whole study, who were present in many phases of the process, from the first IPC meeting in Berlin to the entire Conference in Macao and to the presentation at ICME 13. The process went through the terms of three Presidents of ICMI: Bill Barton, Ferdinando Arzarello and Jill Adler. We thank Jill Adler, the President of ICMI from January 1 2017, who devoted much energy to a thoughtful reading of the manuscript with new eyes and to the agreement for the contract with Springer that allowed, for the first time, to have an Open Access publication in the Niss series. Thanks are given also to Natalie Rieborn (Springer) and the whole SPI staff who were very supportive and patient in the very long process of book preparation. We also wish to thank Shigefumi Mori, the President of IMU, who showed in many ways his deep interest in primary mathematics education.

The ICMI Study co-chairs and the IPC members are very grateful to the participants of the conference for their written papers which appear in the conference proceedings (Sun et al. 2015) and for their significant contributions to the discussions, which highly enriched the contents of this study. Special thanks are for David Pimm who collaborated in a very generous way to the final editing of the volume.

References

- Bartolini Bussi, M. G., & Sun, X. (2014). The twenty-third ICMI study: Primary mathematics study on whole numbers. *Educational Studies in Mathematics*, 86(3), 307–309.
- Bartolini Bussi, M. G., & Sun, X. (2015). Learning from the world: The teaching and learning of whole numbers arithmetic in the ICMI study 23. In Copirelem (Ed.), *Actes du 42e Colloque International des formateurs de mathématiques chargés de la formation des maîtres* (pp. 39–51). Besancon: ARPEME.
- Bartolini Bussi, M. G., & Sun, X. (2016). ICMI study 23: Primary mathematics study on whole numbers. *L'Enseignement Mathématique*, 61(3), 505–517.
- Beckmann, S. (2015) *The twenty-third ICMI study: Primary mathematics study on whole numbers* Retrieved February 10, 2016, from <http://www.stemeducationjournal.com/content/1/1/5>
- Cole, M. (1998). *Cultural psychology. A once and future discipline*. Cambridge, MA: Harvard University Press.
- Even, R., & Ball, D. L. (Eds.). (2009). *The professional education and development of teachers of mathematics. The 15th ICMI study*. New York: Springer.
- Gardner, H. (1989). *To open minds. Chinese clues to the dilemma of contemporary education*. New York: Basic Books.
- Geary, D. (2013). Early foundations for mathematics learning and their relations to learning disabilities. *Current Directions in Psychological Science*, 22(1), 23–27.
- Howe, R. (2017). Report on ICMI study 23 on whole number arithmetic. *NCTM 2017 annual meeting and exposition* (April 05, 2017–April 08, 2017). San Antonio, TX.
- Jaworski, B., Bartolini Bussi, M. G., Prediger, S., & Nowinska, E. (2015). Cultural contexts for European research and design practices in mathematics education. In K. Kreiner & N. Vondrova (Eds.), *CERME9. Proceedings of the Ninth Congress of the European Society for Research in Mathematics Education* (pp. 7–35). Prague: Charles University in Prague, Faculty of Education and ERME.
- Jones, K., Bokhove, C., Howson, G. & Fan, L. (2014). *Proceedings of the International Conference on Mathematics Textbook Research and Development (ICMT-2014)*. Southampton: Education School, University of Southampton. http://eprints.soton.ac.uk/374809/1/ICMT-2014_proceedings150331.pdf
- Jullien, F. (2006). *Si parler va sans dire: Du logos et d'autres ressources*. Paris: éditions du Seuil.
- Levenson, E., Bartolini Bussi M. G., & Erfjord I. (in preparation, 2018). *Early years mathematics*.
- Matar, M., Sitabkhan, Y., & Brombacher, A. (2013). *Early primary mathematics education in Arab countries of the Middle East and North Africa*. Bonn and Eschborn: Deutsche Gesellschaft für Internationale Zusammenarbeit (GIZ) GmbH.
- National Research Council. (2009). *Mathematics learning in early childhood: Paths toward excellence and equity*. Washington, DC: National Academies Press.
- Niss, M. (1993a). *Investigations into assessment in mathematics education: an ICMI study* (Vol. 2). New York/Berlin: Springer.
- Niss, M. (1993b). *Cases of assessment in mathematics education: an ICMI study* (Vol. 1). New York/Berlin: Springer.
- Novotná, J. (2015). *Presentation of the ICMI study 23*. Retrieved February 10, 2016, from www.semt.cz
- Singer, F. M., Sheffield, L. J., Freiman, V., & Brandl, M. (2016). *Research on and activities for mathematically gifted students authors*. New York: Springer.
- Stevenson, W., & Stigler, J. W. (1992). *The learning gap: Why our schools are failing, and what we can learn from Japanese and Chinese education*. New York: Summit Books.

- Sun, X., Kaur, B., & Novotna, J. (2015). (eds.). *Conference proceedings of the ICMI study 23: Primary mathematics study on whole numbers*. Retrieved February 10, 2016, from www.umac.mo/fed/ICMI23/doc/Proceedings_ICMI_STUDY_23_final.pdf
- Suurtamm, C., Thompson, D. R., Kim, R. Y., Moreno, L. D., Sayac, N., Schukajlow, S., Silver, E., Ufer, S., & Vos, P. (2016). *Assessment in mathematics education large-scale assessment and classroom assessment*. Cham: Springer.
- UNESCO. (2012). Challenges in basic mathematics education, by Michèle Artigue. Retrieved January 30, 2017, from <http://unesdoc.unesco.org/images/0019/001917/191776e.pdf>

Open Access This chapter is licensed under the terms of the Creative Commons Attribution 4.0 International License (<http://creativecommons.org/licenses/by/4.0/>), which permits use, sharing, adaptation, distribution and reproduction in any medium or format, as long as you give appropriate credit to the original author(s) and the source, provide a link to the Creative Commons license and indicate if changes were made.

The images or other third party material in this chapter are included in the chapter's Creative Commons license, unless indicated otherwise in a credit line to the material. If material is not included in the chapter's Creative Commons license and your intended use is not permitted by statutory regulation or exceeds the permitted use, you will need to obtain permission directly from the copyright holder.



Chapter 2

Social and Cultural Contexts in the Teaching and Learning of Whole Number Arithmetic



Maria G. Bartolini Bussi  and Xu Hua Sun 

2.1 Introduction

At the first meeting of the ICME 23 IPC group, held in Berlin in January 2014, there was unanimous agreement on the relevance of cultural diversity in ICMI Studies. The Discussion Document for the study noted that:

It was decided that cultural diversity and how this diversity impinges on the early introduction of whole numbers would be one major focus. The Study will seek contributions from authors from as many countries as possible, especially those in which cultural characteristics are less known and yet they influence what is taught and learned. In order to foster the understanding of the different contexts where authors have developed their studies, each applicant for the Conference will be required to prepare background information (on a specific form) about this context. (see this volume, [Appendix 2](#), “Introduction and Rationale for ICMI Study 23”)

This statement was based, on the one hand, on the awareness of the increasing participation of scholars from developing countries in international conferences and of the number of submissions to international journals of manuscripts from all over the world and, on the other hand, on the ICMI aim to improve the quality of mathematics teaching and learning worldwide. Most IPC members, including the first author of this chapter, have experience in reviewing papers for international

The second author was supported by the Research Committee, University of Macau, Macao, China (MYRG2015-00203-FED). The opinions expressed in the article are those of the authors.

M.G. Bartolini Bussi (✉)

Department of Education and Humanities, University of Modena and Reggio Emilia,
Modena, Italy

e-mail: mariagiuseppina.bartolini@unimore.it

X.H. Sun (✉)

Faculty of Education, University of Macau, Macao, China

e-mail: xhsun@umac.mo

© The Author(s) 2018

M.G. Bartolini Bussi, X.H. Sun (eds.), *Building the Foundation: Whole Numbers in the Primary Grades*, New ICMI Study Series,
https://doi.org/10.1007/978-3-319-63555-2_2

conferences and journals: in many papers, there is an implicit belief that the readership knows enough about the context in which a study has been carried out (especially if it concerns European or North American countries) and that the transposition of findings from one country to another is possible and natural, if the theoretical framework and methodology are sound enough.

However, as early as the ICMI Study 8 (1992–1998) on *Mathematics Education as a Research Domain: A Search for Identity* (Sierpinska and Kilpatrick 1998), working group 4, led by Susan Pirie, Tommy Dreyfus and Jerry Becker, was raising questions about the issue of results and their validity. An interesting question was raised:

To what extent can research results from one environment or culture (e. g. Japan) be linked to those from another culture (e.g. the USA) and to what extent are results culture specific?
(p. 27)

Although the issue was raised about 20 years ago, at the ICMI Study Conference in Washington, DC, in 1994, the acknowledgement of the issue of cultural context in major international journals and conferences remains uncommon (Bartolini Bussi and Martignone 2013). In support of this claim, it is enough to quote some excerpts from the information given to prospective authors of empirical studies by one of the major international journals, i.e. the *Journal for Research in Mathematics Education* (NCTM n.d.).

The Journal for Research in Mathematics Education seeks high quality manuscripts that contribute knowledge to the field of mathematics education. For an author's work to be publishable, it needs to exhibit qualities that characterize well-conceived and well-reported research studies. The following information illustrates characteristics of strong manuscripts that have been submitted to JRME.

The following items are then elaborated:

appropriate purpose and rationale
clear research questions
an informative literature review
a coherent theoretical framework
clearly described research methods
sound research design and methods
claims about results and implications that are supported by data
contribution to the field of mathematics education
clearly explained and appropriately used terms
high quality writing
mathematical accuracy.

An abridged version of the same document appears in the PME 39 (2015) guidelines for research reports of empirical studies.

Observational, ethnographic, experimental, quasi-experimental, and case studies are all suitable.

Reports of empirical studies should contain, at minimum, the following:

- a statement regarding the focus of the submitted paper;
- the study's theoretical framework;
- references to the related literature;

- an indication of and justification for the study's methodology; and
- a sample of the data and the results (additional data can be presented at the conference but some data ought to accompany the proposal)

In both cases, no reference to the social and cultural context is explicitly mentioned. Hence, the limited space allowed either for manuscripts or (even more limited) for research reports is likely to inhibit the author's intention of framing the empirical study within its context. Moreover, it implicitly conveys the idea that every relevant scientific communication must follow the above structure, where there is no reference to the social and cultural context. It seems a limiting rather than a proactive statement.

For example, open-class activities/lesson studies that view the classroom as an open or public space, which has been a major influence in the professional development of teachers in China and Japan for many years, may be contrasted with the view of the private and autonomous classroom that has been described as common in the Western tradition (see, for instance, Sztein et al. 2010).

Instead, the evidence of some ongoing changes may be found in the guidelines for reviewers in two subsequent Conferences of the European Society for Research in Mathematics Education. The CERME 8 (2013) guidelines read:

Reports of Studies (Empirical or Developmental)

Surveys, observational, ethnographic, experimental or quasi-experimental studies, case studies are all suitable. Papers should contain at least the following:

a statement about the focus of the paper;

an indication of the theoretical framework of the study reported, including references to the related literature;

an indication of and justification for the methodology used (including problem, goals and/or research questions; criteria for the selection of participants or sampling; data collection instruments and procedures);

results;

final remarks or conclusions

The CERME 9 (2015) guidelines added a new indicator:

an indication on the scientific and cultural context in which this study is embedded (explaining crucial assumptions and the possible contingency of the relevance of the study for a specific cultural context)

What happened between the CERME 8 and CERME 9 guidelines? Both co-chairs of this ICMI23 Study were present at CERME 8, and the first author of this chapter was invited by the organising committee to introduce a forum discussion about the neglected importance of the social and cultural context. The CERME board was favourably impressed and accepted the challenge to adapt the widespread tradition mentioned above. CERME 9's scientific committee not only introduced a small change in the instruction (for authors and reviewers), but also decided to host a panel chaired by Barbara Jaworski on *Cultural Contexts for European Research and Design Practices in Mathematics Education* (Jaworski et al. 2015). The panel was held very successfully in Prague in February 2015. This panel represents a milestone in making explicit international awareness of the importance of the social and cultural context in the teaching and learning of mathematics.

Another milestone is represented by the explicit request for contextual detail in the ICMI Study 23. The ICMI Study IPC unanimously agreed to highlight the role of the social and cultural context and to design a specific form (see below) for collecting relevant information about this context, in order to leave the limited space of the paper (eight pages) for the scientific report according to the usual formats. The aim was twofold: not only to collect relevant information for understanding the different contexts (as explicitly written in the Discussion Document), but also to foster authors' awareness about the relevance of their own cultural contexts.

2.2 The Context Form: Design

The form designed by the IPC tried to address some very basic issues about the situation in the country where either the empirical research study or the theoretical reflections were carried out. The IPC was aware that a complete answer to all the questions would have been very demanding, and akin to a study itself, unless the authors knew some already existing documents at the national level (e.g. ICMI 2011).

The form designed by the IPC follows (Table 2.1).

Some applicants expressed surprise at this unexpected additional task, asking the reasons for completing such a form with information that should already be known by all mathematics educators: this was further evidence, if any were needed, that the awareness of the relevance of the social and cultural context and the need to offer information about these are far from being shared in the field.

The following story of the Macao Conference, with the visit to Chinese schools and with the discovery of the differences between Western and Eastern mathematical traditions, provided further evidence that this awareness is really needed and useful in order to understand and to start a fruitful dialogue between different cultural contexts. This aspect will be further elaborated in this chapter and in the whole volume.

2.3 The Context Form: Data

Sixty-six context forms were collected, concerning 29 countries (counting separately China and SARs Hong Kong and Macao). The distribution by country is detailed in Table 2.2.

Three submitted papers concerned cross-cultural studies (Cyprus – Netherlands, Germany – Australia, England – Sweden, where the context forms for both countries were filled (and, hence, were counted twice in the above table). In one case, the submitted paper concerned a cross-cultural study where all the Francophone countries were analysed for a study commissioned by the World Bank: a single context

Table 2.1 The context form

Please fill in as many of the following as completely as possible so that we understand the context of your paper	
General (objective data)	Give a rough idea of the numbers of:
	Students up to the age of 11 years
	Teachers for pre-primary and primary education
	A short description of the National Education System (please match grades with pupils' age)
	If relevant, please explain whether the system is inherited from colonial period or is related to local traditions
	Give information about what you consider an important feature in your country (e.g. the pillar of the network of monastic schools in Burma)
Inclusiveness	Is the system totally inclusive?
	Are there special schools/classrooms for sensually impaired students (blind, deaf)?
	Are there special schools for students with disabilities?
National language(s)	List the national language(s) of the country
	List the local languages (minorities)
	Is pre-primary/primary school carried out in the local languages?
Migrant/refugee/marginalised students	Is there a significant minority of migrating students (coming from other countries), of refugee students and of marginalised students?
	Are there specific rules for schools which take care of these students? Is there some help from the national/local government?
Pre-primary general	Is pre-primary education extended to the whole country?
	Which percentage of students are expected to enrol in pre-primary education?
Pre-primary textbooks	Do they exist?
	In what language (in the case of more local languages)?
	Is there only one national textbook? Or a limited number?
	Is there only one teachers' guide? Or a limited number?
Primary general	Is primary education extended to the whole country?
	Which percentage of students are expected to enrol in primary education?

(continued)

Table 2.1 (continued)

Please fill in as many of the following as completely as possible so that we understand the context of your paper	
Primary textbooks	Do they exist? In what language (in the case of more local languages)?
	Is there only one national textbook? Or a limited number?
	Is there only one teachers' guide? Or a limited number?
Primary teachers' qualification	Generalists or specialists?
Assessment	Is there a national system of assessment?
	At what ages/grades are students assessed in mathematics (focus on both pre-school and primary school)?
Standards	Is there a governmental/national document for standards?
Teacher education and development	What are the national rules?
	Is there some shared practice you consider relevant (e.g. Lesson Study in Japan, <i>guānmó kè</i> in China)?
	Do you have forms of distance learning for teacher development?
Teacher education and development: pre-primary	How is organised pre-primary teacher education?
	Please distinguish (if relevant) the governmental rules and what happens in practice?
Teacher education and development – primary	How is organised primary teacher education?
	Please distinguish (if relevant) the governmental rules and what happens in practice?
Contents (limiting the focus to whole numbers)	Local languages
	Place value: do you have tradition of system of representation in base not ten?
	Problems: which kind of problems are typical of school practice? (e.g. China: problems with variation)
	Problems: which kind of problem-solving strategies? (e.g. Singapore: model method)?
Any other information related to the context of your paper	

form was filled for all the Francophone countries, with reference to the colonial influence of the French system.

The applicants were encouraged to fill the form as completely as possible, drawing on their own knowledge. Hence, rather than on objective data, in most cases, the information drew on applicants' knowledge and perceptions of their national contexts. Moreover, the sample was a convenience sample involving the selection of the most accessible subjects (Marshall 1996), limited to the applicants in the study,

Table 2.2 The countries

Country	Number of forms	Country	Number of forms
Algeria	1	Australia	5
Belgium	1	Brazil	1
Canada	4	China	5
China HK SAR	2	China Macao SAR	2
Cyprus	1	Czech Republic	1
Denmark	1	Dominican Rep.	1
England	1	France	4
Germany	4	Israel	3
Italy	4	Jordan	1
Netherlands	2	New Zealand	2
Serbia	1	Singapore	1
South Africa	3	Sweden	2
Switzerland	1	Taiwan	4
Thailand	1	USA	5
Vietnam	1	All Francophone countries	1

hence excluding or limiting the contribution of some major areas (e.g. India, Russia, Latin America, much of Africa, Southeast Asia).

In the following, we briefly outline the main outcomes of an early analysis of the collected data.

2.3.1 The General Structure of Education Systems for Early Years Mathematics

The data reported by the applicants have been matched with Education Database (n.d.). Although in some countries (e.g. Australia, Brazil, Canada, Cyprus, Germany, Switzerland, USA) there are differences between the different states/provinces/regions/territories, the models may be summarised as follows. While primary school or elementary school is the accepted wording, in some cases pre-primary school is named in different ways. Usually pre-primary is not mandatory but attended by many students (in some cases up to 95%) at least in the last year before entering primary school.

In some cases primary school is split into different steps including also what is elsewhere called middle school. Although our convenience sample is limited to 29 countries, there is a large variety, concerning both the duration and the entry age. In Europe too different models exist. This institutional diversity has implications for this study: for instance, when the entry age is postponed, it is likely that WNA is approached at pre-school level, and when the duration is extended (up to sixth grade, as in many Eastern countries), it is likely that pre-algebraic thinking is fostered before high school level. As these institutional differences cannot be cancelled,

in this study we chose to focus on the contents rather than on the grades or the students' age (Table 2.3).

The influence of colonial heritage is reported in some countries: Algeria, Australia, China HK, China Macao, New Zealand, Taiwan (from Japan and China). This influence in some cases emerges also in the choice of school language different from family language. This issue was reported and discussed also in the Conference (this volume, Chap. 3).

2.3.2 *Inclusiveness in Education*

The focus on inclusive education has a long story in UNESCO's documents (e.g. UNESCO 2009a; see the historical summary on p. 9) and dates back to the Universal Declaration of Human Rights (1948), but it is still actual (see, for instance, the plenary speech by Bill Barton in ICME 13¹). Inclusive education was taken into account in the *Millennium Developmental Goals* criteria (UNESCO 2010), where *Universal Primary Education* (UPE) is mentioned (Millennium Developmental Goal 2). It is considered also in the most recent document (UNESCO 2017) on *Education for Sustainable Development Goals*, where it is included in the learning objective 4: 'Quality Education | Ensure inclusive and equitable quality education and promote lifelong learning opportunities for all' (UNESCO 2017, p. 18 ff.).

UNESCO (2009a) states that inclusion addresses not only students with special needs² (e.g. disable students), but also those from diverse backgrounds (cognitive, ethnic and socio-economic). Hence, this issue is related to some other questions posed in the context form (i.e. national languages and school languages, provisions for migrant, refugee and marginalised students).

This broad approach was assumed by the IPC of the study which included in the context form three different items (see above) concerning students with special needs, students with school language different from family language and students with diverse background.

The presence of different national languages has been reported by applicants, mentioning also local languages. There are countries where home languages are different from national language (or languages), for instance, in Algeria, Arabic and Berber–Tamazight; in Australia, Australian English and aboriginal languages; in Belgium, Dutch, French and German; in Canada, English and French; in the Chinese

¹ <https://lecture2go.uni-hamburg.de/l2go/-/get/v/19757>

² We are aware that there is a growing trend towards abandoning the wording 'special needs' and using 'special rights' or 'educational rights'. For instance, Runswick-Cole and Hodge (2009) have argued for abandoning the language of 'special education needs' in the UK, based on the claim that it has led to exclusionary practices, mentioning an Italian rights-based approach developed in Reggio Emilia that refers to 'children with special rights' drawing on the United Nations Convention of the rights of the child (UNICEF 1989). Yet we decided to maintain the most common wording 'special needs' as it is shared in literature and better known by mathematics educators.

Table 2.3 Structure of primary school

4-6 age: 6-10 (12)	5 age: 6-11	5-6 age: from 6	6 age: from 5	6 age: 6-12	6 age: 7-13	5-6-7 age: from 6	7 age: 7-14	8 age: 4-12	8 age: 7-15	9 age: 6-15	9 age: 7-16	10 age: from 6-16
<i>Germany</i> (depending on region)	<i>Algeria</i> (under colonial influence)	<i>Cyprus</i> (Greek, 6; Turkish, 5)	<i>UK</i> (complex system)	<i>Australia</i>	<i>Taiwan</i>	<i>Canada</i> (depending on territories)	<i>South Africa</i>	<i>Netherlands</i>	<i>Serbia</i>	<i>Brazil</i> (5+4)	<i>Denmark</i>	<i>Jordan</i>
	<i>France</i>			<i>Belgium</i>	<i>Singapore</i>							
	<i>Italy</i>	<i>China</i>	<i>Hong Kong</i> (modelled after UK system)	<i>Switzerland</i> (complex system)	<i>Dom. Rep.</i>							
	<i>Vietnam</i>	<i>Macao</i> (under different influences)			<i>New Zealand</i>							
	<i>USA</i> (complex system)			<i>Israel</i> (complex system based on religions)								
				<i>Thailand</i>								

area, Mandarin, Cantonese and minorities languages; in Cyprus, Greek and Turkish; in Israel, Hebrew and Arabic; in New Zealand, English, Te Reo Maori and New Zealand Sign Language; in Serbia, Serbian, Hungarian and Romanian; in Singapore, English, Malay, Tamil and Mandarin; in South Africa, Afrikaans, English, Zulu, Xhosa, Swati, Tswana, Southern Sotho, Northern Sotho, Tsonga, Venda and Ndebele; in Sweden, Swedish, Finnish, Meankeli, Samic, and so on; in Switzerland, French, German, Italian and Romansh; in Thailand, Thai and Esann; and in the USA, English and Spanish. In most cases, the language of teaching (or school language) is different from home languages with the well-known critical consequences (Barwell et al. 2016). There are countries with acknowledged minorities (e.g. Czech Republic, France, Italy, New Zealand) where teaching in the minority language is encouraged with special funds and programmes. For instance, in New Zealand, Maori schools are very well developed and address about 15–20% students.³

The issue of migrant, marginalised and refugee students is mentioned by some applicants, although only in a few countries (e.g. Australia, Belgium, Cyprus, Germany, Jordan, Netherlands, New Zealand) official governmental support is mentioned. In other cases (e.g. France, Italy, UK), municipal support is mentioned together with the involvement of volunteers and charities.

According to the data reported in UNESCO (2017) and confirmed by some participants, there has been significant progress towards ensuring UPE in terms of access, and the conversation has now shifted from aiming for access to goals for quality UPE.

The question of students with disabilities or special needs seems to be ill-posed or, maybe, ill-interpreted by the applicants to the Conference. In many cases, applicants answered YES (i.e. the system is inclusive) probably meaning that all the students are allowed to go to primary school, but in many cases (at least 12 out of 29), special schools for disabled students were mentioned as the only provision.

According to UNESCO (2009a):

In most countries, both developed and developing, the steps towards achieving the right to education for students with disabilities have followed a common pattern, with some local variations. Progress has tended to follow the pattern of steps outlined below:

Exclusion from school, based on negative attitudes and a denial of rights, justified by the belief that students with disabilities cannot learn or benefit from education

Segregation, reflecting the emphasis on ‘difference’, combined with a charity-based approach, where separate education centres and schools were and are still provided by local, regional and international charitable NGOs and, more recently, by development-focused NGOs

Integration, reflecting some degree of acceptance for some disabled students, depending on their degree of disability, allowing them to attend local regular national schools, as long as they can fit in to the school and the school does not have to make significant adjustments for them

Inclusion in education, acknowledging the fact that all students, including those with disabilities, have the right to education, that all schools have the responsibility to teach every child and that it is the responsibility of the school to make the adjustments that may be necessary to make sure that all students can learn (p. 51)

³ www.education.govt.nz/ministry-of-education/our-role-and-our-people/education-in-nz/

Following this definition, if the system of special schools is widespread in a country, it is a *segregation* model and not an *inclusive* model.

To sum up the data, most countries are reported to have special schools only; some countries (e.g. Australia, Brazil, Canada, Czech Republic, Denmark, France, Germany, Israel, Netherlands, New Zealand) have started a process of *integration*, and some countries have stated by law complete *inclusion* in mainstream classes with support teachers. A relevant case, worthwhile to be mentioned, is Italy. D'Alessio (2011) reconstructs the historical and legislative backgrounds of the integration policy in Italy, mentioning the promulgation of the Italian Constitution (Senato della Repubblica 1947), where the spirit and ethos for integration were already encapsulated.

Since the Fascist dictatorship had denied individual freedom, one of the first targets of the democratic Constitution was to put the dignity of the person and the rights of minorities at the centre of the constitutional charter. (D'Alessio 2011, p. 6)

In the following years, legislation went in this direction. According to Ferri (2008), for Italian teachers, inclusion was considered 'a moral issue which is more important than a legal mandate' (p. 47). A discussion about the possible distance between laws and implementation is made by Booth and Ainscow (2011) which have designed a tool to support and assist with the process of developing inclusive education.

At the international level, inclusive education is considered to be:

a key vehicle through which the right to an equal education opportunity for all can be ensured. For this to become a reality it is necessary to provide a system in which all persons, including persons with disabilities, can access education at all levels on an equal basis with others in the communities in which they live. They should not be excluded on the basis of any disability and should get the support they require. (EASPD 2012, p. 6)

It must be said, however, that the issue of *exclusion-segregation-integration-inclusion* is far from being agreed upon at the international level. It is not only a matter of clear definitions; it is rather a matter of ethical consensus. A recent paper by Reindal (2016) summarises different positions, reconstructing the history of the inclusion debate from the 'World Conference on Special Needs Education' in Salamanca in 1994. Reindal claims:

Inclusive education as presented in documents from UNESCO was indefinite from the start in relation to both the target group and those whose responsibility was to implement inclusive education for that group. Reviews of the research also support several interpretations of responsibility and elucidations of inclusive education. In a recent study based on prior reviews and a recent search of databases covering the period 2004–2012, Goransson and Nilholm (2014a) found four different interpretations of inclusion which gave rise to four qualitatively different categories of definitions. These definitions were related hierarchically to each other employing stricter criteria concerning what counts as inclusive education as one goes from A to D:

- (A) Placement definition – inclusion as the placement of pupils with disabilities in mainstream classrooms.
- (B) Specified individualised definition – inclusion as meeting the social/academic needs of pupils with disabilities.

- (C) General individualised definition – inclusion as meeting the social/academic needs of all pupils
- (D) Community definition – inclusion as creation of communities with specific characteristics.

Reindal (2016) suggests to tackle this issue from the perspective of a *capability approach* (Walker and Unterhalter 2007), as that:

has the potential to emphasise the ethical aspects of inclusion because it builds on an understanding of difference as a specific variable of human diversity, and because it understands human dignity as the development of capabilities. The capability approach defends an understanding of difference as a specific variable of human diversity with an objective reality. [...] If the central purpose of special education and inclusion is to treat all students as the same while at the same time aiming to treat them differently then one must deal with the problem of difference in a way that comes to grips with the attendant challenges – as well as those faced particularly by developing countries. (Reindal 2016, p. 6)

The issue of the diversity of school language and family language was discussed during the Conference and finds place in this Volume (e.g. Chap. 3, 4 and 9). The issue of students with special needs was discussed during the Conference and reported in some chapters (e.g. Chaps. 7, 8, 9, 16 and 20).

The capability approach, one that is very interesting, was not picked up in the Study and may suggest future developments in mathematics education.

2.3.3 *Textbooks*

Most applicants reported that no textbook for pre-primary exists: rather, some available collections of learning resources, working sheets and teachers' guides are mentioned.

As far as primary school is concerned, textbooks exist everywhere, although in some cases (e.g. Australia) the adoption of a textbook is not mandatory. In most countries there is a free-market system with no official overlooking agency. In some countries only one or a limited number of approved textbooks is available (e.g. Chinese area, Algeria, Germany, Singapore and Thailand). In Vietnam, textbooks are written by specialists of the Ministry of Education. In South Africa, there are textbooks in all the national languages, though harder to access in the smaller language groups. In China too, there are textbooks in all the minority languages.

In this Study, the issue of textbooks was just skimmed in the Chaps. 9 and 11 but would deserve a study in its own.

2.3.4 *National Curriculum Standards and Assessment*

In nearly all the countries of this convenience sample, there are national standards. They do not exist in Algeria and are identified with the sole national textbook in Jordan. An interesting case is represented by the USA. There is no national

curriculum in the USA, but National Council of Teachers of Mathematics (NCTM) Standards are widespread. Yet, locally, states, school districts and national associations recommend some curriculum standards be used to guide school instruction. The Common Core Standard initiative⁴ is in progress. In nearly all the countries, there is a national system of assessment (in progress in New Zealand) consistent with curriculum standards. However, the grades in which assessment takes place are not the same. Usually they are every second or third year and depend also on the structure of the education system (see Sect. 2.3.1).

2.3.5 *Teachers' Qualification and Teacher Education and Development*

All the applicants reported a *generalist* trend for primary teacher education in their countries, with some limited exceptions: Germany, with the encouragement to get further qualification in German or Mathematics, and Italy, with testing of specialist mathematics teachers in some schools, according to autonomous choices of the school council. Only in Denmark and in the Chinese area a trend towards specialist mathematics teachers is reported. In China, this choice is common in big cities but not in rural areas. Where there are specialist mathematics teachers, it is common to form a Mathematics Teaching Research Group in the school, for in-service development according to the model of 'open classes', called in Chinese *guānmó kè* (观摩课), which means 'to observe for imitating a lesson' and has some similarities to the Japanese lesson study (Sun et al. 2015).

In our convenience sample, pre-service teacher education at universities (or, in some cases, teachers' colleges) seems well established. In most cases for pre-primary and primary school, the length of the programme (bachelor) is the same:

3-year bachelor in Belgium and New Zealand

4-year bachelor in Australia, Canada, Chinese area, South Africa, Switzerland

5-year master in Italy

6-year master in Thailand

In other countries, the length is different for pre-primary and primary school teachers:

2–3 years in Singapore (at the National Institute of Education)

3–4 years in Denmark, Serbia

3 1/2–4 years in Sweden

In some cases the length of the bachelor degree is not reported.

In Germany no university programme for pre-primary teachers is reported, while the programme for primary teachers is at masters level (5 years).

In France there is no information provided for pre-primary, while the programme for primary teachers is at masters level (5 years).

⁴www.corestandards.org

In the USA the rules are different in different states. For primary teachers, bachelor degrees are mentioned.

In the UK, different agencies are involved with programmes of different lengths (e.g. school-led teacher training, university programmes).

Practicum (internship) is mentioned with very different organisations and durations, for instance, a 600 hours practicum is required in Italy alongside the 5-year master programme, while in Israel, the practicum is at the end of the university programme. A year of practicum is required in Macao alongside the 4-year bachelor degree. In Australia 80 hours of mandatory practicum is prescribed for bachelor programmes.

Distance learning is mentioned especially for in-service teacher development. However, for in-service development, different models are described from inspector-led programmes, to mandatory programmes (60 hours per year in Israel, 5 days per year in Switzerland). In Australia, there is a programme for accreditation according to well-described professional standards. In some cases in-service development is appointed to municipalities (Sweden). In many cases in-service development is reported as not effective. It seems that, in general, there are not well-organised models. A relevant exception is the model of ‘open classes’ in China (see Sect. 2.3.3).

For teacher education and development, besides the panel on teacher education (this volume, Chap. 17), it is worthwhile to mention the ICMI Study 15 (Even and Ball 2009).

2.4 Conclusion

In this chapter we have briefly explored mainly structural features of the instruction systems including inclusiveness, curricula, standards and assessment and teacher education and development. We had just a glance to the many different choices existing in the countries of our convenience sample.

Our limited analysis shows that even in Europe, a small continent, many different organisations of the education systems exist. Education systems are cultural artefacts that could be studied, on the one hand, as products of socio-cultural contexts and, on the other hand, as sources of information about the society that constructed or adopted them. We do hope that, in the future, a sensitive attitude for cultural contexts will become more and more shared, in international journals and conferences. As stated by Bartolini Bussi and Martignone (2013):

The question of cultural background applies to every study in mathematics education [...] It is necessary to explain in more depth how the research design and implementation is related to the cultural background: the results and success (if any) of the project may depend on implicit values which are not likely to be found in other contexts. (p. 2)

In this spirit, the investigation of the different social and cultural contexts continued throughout the whole study and is mirrored in the Study Volume.

References

- Bartolini Bussi, M. G., & Martignone, F. (2013). Cultural issues in the communication of research on mathematics education. *For the Learning of Mathematics*, 33(1), 32–38.
- Barwell, R., Clarkson, P., Halai, A., Kazima, M., Moschkovich, J., Planas, N., Phakeng, M., Valero, P., & Villavicencio Ubillús, M. (2016). *Mathematics education and language diversity: The ICMI study 21st*. Cham: Springer.
- Booth, T., & Ainscow, M. (2011). *Index for Inclusion: Developing learning and participation in schools* (3rd revised ed.). Canterbury: Centre for Studies on Inclusive Education.
- CERME 8. (2013). <http://cerme8.metu.edu.tr/#>. Retrieved January 24, 2016.
- CERME 9. (2015). <http://www.cerme9.org/guidelines/>. Retrieved January 24, 2016.
- D’Alessio, S. (2011). *Inclusive education in Italy. A critical analysis of the policy of “integrazione scolastica”*. Rotterdam: Sense Publishers.
- EASPD. (2012). *Analysis of the use and value of the Index for Inclusion (Booth and Ainscow 2011) and other instruments to assess and develop inclusive education practice in P2i partner countries*. Brussels/Tilburg, Fontys OSO. <http://www.icevi-europe.org/enletter/issue51-09EASPD3.pdf>. Retrieved December 27, 2016.
- Education database. (n.d.). <http://www.classbase.com/Countries>. Retrieved January 24, 2016.
- Even, R., & Ball, D. L. (2009). *The professional education and development of teachers of mathematics: The 15th ICMI study*. New York: Springer.
- Ferri, B. (2008). Inclusion in Italy: What happens when everyone belongs. In S. L. Gabel & S. Danforth (Eds.), *Disability and the politics of education: An international reader* (pp. 41–52). New York: Peter Lang Publishers.
- Göransson, K., & Nilholm, C. (2014). Conceptual diversities and empirical shortcomings: A critical analysis of research on inclusive education. *European Journal of Special Needs Education*, 29(3), 265–280. <https://doi.org/10.1080/08856257.2014.933545>.
- ICMI (2011). *The ICMI database project*. <http://www.mathunion.org/ICMI/Activities/Database-Project/Introduction/>. Retrieved January 24, 2016.
- Jaworski, B., Bartolini Bussi, M. G., Prediger, S., & Nowinska, E. (2015). Cultural contexts for European research and design practices in mathematics education. In K. Kreiner & N. Vondrova (Eds.), *CERME9. Proceedings of the Ninth Congress of the European Society for Research in Mathematics Education* (pp. 7–33). Prague: Charles University in Prague, Faculty of Education and ERME.
- Jones, K., Bokhove, C., Howson, G., & Fan, L. (2014). *Proceedings of the International Conference on Mathematics Textbook Research and Development*. Southampton: University of Southampton. Retrieved June 2, 2016 from <http://eprints.soton.ac.uk/374809/>
- Marshall M. N. (1996) Sampling for qualitative research. *Family Practice*, 13(6), 522–525.
- NCTM. (n.d.). *Characteristic of a high quality JRME manuscript*. <http://www.nctm.org/publications/write-review-referee/journals/Characteristics-of-a-High-Quality-JRME-Manuscript/>. Retrieved January 24, 2016.
- PME 39. (2015). *Submissions: Research reports*. <http://www.pme39.com/submissions/>. Retrieved January 24, 2016.
- Reindal, S. M. (2016). Discussing inclusive education: An inquiry into different interpretations and a search for ethical aspects of inclusion using the capabilities approach. *European Journal of Special Needs Education*, 31(1), 1–12.
- Runswick-Cole, K., & Hodge, N. (2009). Needs or rights? A challenge to the discourse of special education. *British Journal of Special Education*, 36(4), 198–203.
- Senato della Repubblica. (1947). *Constitution of the Italian Republic*. https://www.senato.it/docu-menti/repository/istituzione/costituzione_inglese.pdf. Retrieved 10 December 2016.
- Sierpinska, A., & Kilpatrick, J. (1998). *Mathematics education as a research domain: A search for identity, An ICMI study*. Dordrecht: Springer.

- Sun, X.H., Teo, T., & Chan, T.C. (2015). Application of the open-class approach to pre-service teacher training in Macao: A qualitative assessment. *Research Papers in Education*, 30(5), 567–584.
- Sztein, E., Olson, S., & Ferreras, A. (Eds.). (2010). *The teacher development continuum in the United States and China: Summary of a workshop*. Washington, DC: The National Academies Press.
- UNESCO. (2009a). *Towards inclusive education for students with disabilities: A guideline*. Bangkok: UNESCO Asia and Pacific Regional Bureau for Education. <http://unesdoc.unesco.org/images/0019/001924/192480e.pdf>. Retrieved October 25, 2017.
- UNESCO. (2009b). *Policy guidelines on inclusion in education*. Paris: United Nations Educational, Scientific and Cultural Organization. unesdoc.unesco.org/images/0017/001778/177849e.pdf. Retrieved April 24, 2017.
- UNESCO. (2010). *Resolution adopted by the General Assembly. 65/1. Keeping the promise: United to achieve the Millennium Developmental Goals*. www.un.org/en/mdg/summit2010/pdf/outcome_documentN1051260.pdf. Retrieved April 24, 2017.
- UNESCO. (2017). *Education for sustainable development goals*. Learning objectives. <http://unesdoc.unesco.org/images/0024/002474/247444e.pdf>. Retrieved April 24, 2017.
- UNICEF. (1989). *Convention on the rights of the child*. www.unicef-irc.org/portfolios/crc.html. Retrieved April 25, 2017.
- Walker, M., & Unterhalter, E. (2007). The capability approach: Its potential for work in education. In M. Walker & E. Unterhalter (Eds.), *Amartya Sen's capability approach and social justice in education* (pp. 1–18). London/New York: Palgrave Macmillan.

Open Access This chapter is licensed under the terms of the Creative Commons Attribution 4.0 International License (<http://creativecommons.org/licenses/by/4.0/>), which permits use, sharing, adaptation, distribution and reproduction in any medium or format, as long as you give appropriate credit to the original author(s) and the source, provide a link to the Creative Commons license and indicate if changes were made.

The images or other third party material in this chapter are included in the chapter's Creative Commons license, unless indicated otherwise in a credit line to the material. If material is not included in the chapter's Creative Commons license and your intended use is not permitted by statutory regulation or exceeds the permitted use, you will need to obtain permission directly from the copyright holder.



Chapter 3

Language and Cultural Issues in the Teaching and Learning of WNA



Xu Hua Sun  and Maria G. Bartolini Bussi 

3.1 Introduction

3.1.1 Reflections on Language and Culture Before, During and After the Macao Conference

Language is an artefact used to communicate and think (see Chap. 9). Languages differ not only in pronunciation, vocabulary and grammar, but also the different ‘cultures of speaking’. Language plays a common, key role in conveying mathematics concepts for learning and teaching and the development of mathematical thinking. The features of language can help to make numerical concepts transparent and support the understanding that occurs in learning discourse. A cross-cultural examination of languages should thus allow us to understand the linguistic support and limitations that may foster/hinder students’ learning and teachers’ teaching of mathematics. This study examines number naming and structure across languages and language issues related to whole number structure, arithmetic operations and key concepts, and thus has important educational implications for whole number arithmetic.

The first author was supported by Research Committee, University of Macau, Macao, China (MYRG2015-00203-FED). The opinions expressed in the article are those of the authors.

X.H. Sun (✉)

Faculty of education, University of Macau, Macao, China

e-mail: xhsun@umac.mo

M.G. Bartolini Bussi (✉)

Department of Education and Humanities, University of Modena and Reggio Emilia,
Modena, Italy

e-mail: mariagiuseppina.bartolini@unimore.it

© The Author(s) 2018

M.G. Bartolini Bussi, X.H. Sun (eds.), *Building the Foundation: Whole Numbers in the Primary Grades*, New ICMI Study Series,
https://doi.org/10.1007/978-3-319-63555-2_3

As reported in Chap. 2, this study aims to foster awareness of the relevance of cultural diversity in the teaching and learning of whole number arithmetic and in related studies. As stated in ICMI Study 21 (Barwell et al. 2016, p. 17), ‘language and culture are closely and intimately related and cannot be separated’. Language and culture influence each other. Language is part of culture and plays an important role in it. A language not only contains a nation’s cultural background, but also reflects a national view of life and way of thinking. Hence, no discussion of language issues in whole number arithmetic can be separated from cultural background.

In this chapter, we address language and cultural issues based on different examples reported by the conference participants, which can be roughly divided as follows:

- The language of whole number arithmetic in Indo-European languages
- The colonial case in Africa
- The Chinese case

We also consider some of the educational implications.

A short outline of Chinese grammar for numbers is collected for the interested reader, who may in this way become acquainted with some background of the Chinese mathematics education. This special focus on the Chinese language and culture depends on:

- The ‘perfect’ match between everyday Chinese arithmetic and the mathematician’s arithmetic (Sun 2015).
- The very interesting organisation of Chinese curricula that has seemingly proceeded uninterrupted since classic times (see Chap. 5).
- The presence of some original strategies (e.g. variation problems) (Sun 2011, 2016).
- The performance of Chinese students and teachers (e.g. Geary et al. 1993; Ma 1999).
- The circumstance of us meeting together in China and seeing a Chinese first-grade lesson in person (see Chap. 11).

The presence of different cultural and linguistic traditions makes participants and readers aware of the choices that have been made throughout history regarding the teaching and learning of whole number arithmetic, creating an improved awareness of cultural diversity in mathematics. This diversity does not allow for the simple adoption of curricula developed by others, unless a careful process of *cultural transposition* (see Chap. 13) is started. An example at the end of the chapter (Sect. 3.4.5.2) illustrates this point.

3.1.2 *Some Everyday Language Issues in Number Understanding*

An assumption of the universality of whole number arithmetic has been predominant for both curriculum reformers and international evaluators. The so-called Hindu-Arabic system of numerals as number signs is considered the most effective computation tool and has consequently been adopted by countries around the world during the last century. However, in this chapter, we discuss how whole number arithmetic is not culture-free, but rather deeply rooted in local languages and cultures, and present the inherent difficulty of transposition from language and culture perspectives.

Information about how words are connected with whole number arithmetic may be found in many books (e.g. Menninger 1969; Zaslavsky 1973; Ifrah 1981; Lam and Ang 2004). We do not aim to summarise what can easily be found elsewhere. Our intention is to systematically collect some of the information and reflections shared between the conference participants who represented many cultural contexts and report on some of the features of their languages/cultures that have important educational implications.

Before approaching the topic of whole number arithmetic, we examine some of the studies conducted in the linguistic field, particularly in the field of *pragmatics*, where the contrast within the same culture between figurative meaning in everyday language and literal meaning in school arithmetic language is investigated. As the examples (Bazzanella, personal communication) come from very different languages and cultures, this phenomenon seems universal despite having different features.

The roots of this phenomenon may be found in ancient ages. In *Poetics*, Aristotle himself introduces the idea of the *metaphor*, which consists of giving a thing a name that belongs to something else. Among the different examples, one concerns numbers: “‘Indeed ten thousands noble things Odysseus did,’ for ten thousand, which is a species of many, is here used instead of the word ‘many’” (Levin 1982, p. 24).

In ancient China, ‘ten thousand’ (wàn, 万) was used in a figurative way, as in the proper name for ‘the Great Wall’ (万里长城, wàn lǐ chángchéng). This name literally means ‘ten thousand lǐ long wall’, where *lǐ* is an ancient unit of length used to highlight the immense length of the wall.¹

In the last decades, linguistic scholars have started to investigate the use of numbers (whole numbers) in everyday language. There are several issues involved in this usage, such as *indeterminacy* and *approximation*. Indeterminacy in language is commonly resorted to for a variety of reasons and takes several different forms (Krifka 2007; Bazzanella 2011). In some applications of numerals, exact numbers are used systematically to denote indefinite quantities. Such uses are linked to certain very specific numerals, either rather low ones (2, 3, 4, 5) or high but ‘round’ ones (100, 1000). They are *hyperbolic* in the sense that the number indicated cannot

¹https://en.wikipedia.org/wiki/Great_Wall_of_China

be true; moreover, several variants of one expression (100, 1000, 10,000, etc.) often coexist (Lavric 2010). Lavric (2010) collects several examples from European languages (English, French, German, Italian and Spanish) where the meaning of whole numbers is not the same as the numerals learnt in counting. Some expressions in some languages must be interpreted in an approximate way. For instance, the sentence ‘*vuoi due spaghetti?*’ (do you wish to have *two* spaghetts?) among Italian speakers means ‘do you wish to have some spaghetti?’ Hence, ‘two’ is not used in its cardinal meaning but means a general number of things. Round numbers (i.e. powers of ten, such as ten, a hundred, a thousand, ten thousand, a hundred thousand, a million) are also used in hyperbolic meaning: ‘I have told you a thousand times that you have to be prudent’. Fractions may be used to mean a very small number (‘half’ also sometimes means a part when the original is divided into two parts that may not be equal), with the numerator ‘one’, and a high and round numerator (e.g. ‘even a millionth of a second’) is used to minimise or a very close numerator and denominator used to maximise (e.g. ‘it is ninety-nine point nine percent certain’). Apart from European languages, in Mandarin Chinese, approximate numerical expressions are classified into two main types with different meanings: one with the discourse marker *bā* (吧) denoting the approximate quantity and the other without an explicit marker denoting the exact quantity (Ran 2010). These aspects are studied in linguistics for their effects on translations from one language to another, when literal translation is impossible. They are not usually considered in the literature on mathematics education, although they are important to the connection (continuity vs discontinuity) between everyday language and school language.

3.2 Place Value in Different School Languages and Cultures

3.2.1 Some Reported Difficulties in Understanding Place Value

How is number naming in daily language related to the structure of numbers in school mathematics? How do listeners in the mathematics classroom recognise numerical concepts? What are the cognitive bases of approximate uses? What are their effects on cognitive processes? We discuss these language issues related to the comprehension of place value in the following.

Place value is the most important concept in the so-called Hindu-Arabic system, as it has a long-term effect on the comprehension of number structure and calculations. It denotes the value of a digit depending on its place or position in the number. Each place has a value of ten times the place to its right. In Chinese literature, place value is emphasised as an understanding of numeration with different units (計數單位). Recording magnitude with different units in counting is called *place value* in English-speaking communities or *positional notation* in French-speaking communities. In place value, there are two inseparable principles (Houdement and Tempier 2015):

- The *positional principle*, where the position of each digit in a written number corresponds to a unit (e.g. hundreds stand in the third place)
- The *decimal principle*, where each unit is equal to ten units of the immediately lower order (e.g. one hundred = ten tens)

However, a range of studies shows that the teaching and learning of place value/numeration units is difficult. For example, Tempier (2013) finds low percentages of success of 104 French third graders (8- to 9-year-olds) in tasks involving relations between units: ‘1 hundred = ... tens’ (48% success), ‘60 tens = ... hundreds’ (31% success) and ‘in 764 ones there are ...tens’ (39% success). Even in the fourth and fifth grades, no more than half of the students demonstrate an understanding that the ‘5’ in ‘25’ represents five of the objects and the ‘2’ the remaining 20 objects (Kamii 1986; Ross 1989).

Bartolini Bussi (2011) mentions a similar difficulty (see Sect. 9.3.2):

When 7-year-old students are asked to write numbers, a common mistake in transcoding from number words to Hindu-Arabic numerals shows up: some students write ‘10,013’ instead of ‘113’ as the zeroes on the right (100) are not overwritten by tens and units. (p. 94)

It should not be surprising that these students cannot grasp multi-digit addition and subtraction. Many curricula in the West list place value as positional knowledge only. For instance, Howe (2010) offers a critique of elementary curricula in the USA:

Place value...is treated as a vocabulary issue: ones place, tens place, hundreds place. It is described procedurally rather than conceptually.

Bass (see Chap. 19) uses the problem of counting a large collection to stimulate the development of grouping with multiple units, according to the concept of place value. Young-Loveridge and Bicknell (2015) advise supporting the comprehension of place value by providing meaningful multiplication and division at the same time. Place value is inherently *multiplicative* (Askew 2013; Bakker et al. 2014) and usually introduced as part of the addition and subtraction of multi-digit numbers before children have experienced meaningful multiplication and division. In Chap. 9, we report on artefacts designed and used to overcome some difficulties in the introduction of place value. Based on the studies that have been conducted, a language perspective on place value is rare in the mathematics education field. In this chapter, we wish to reconstruct some part of the history of place value while looking at it from the language perspective.

3.2.2 Transparency and Regularity of Number Languages: Some European Cases

In Europe, place value was introduced in the thirteenth century through the Arabic tradition and came into conflict with previous traditions (Menninger 1969; Lam and Ang 2004). This explains why the principle of place value continues to be a specific

part of school curricula (Fuson and Briars 1990). Units of hundreds and thousands are always explicit, but units of ones and tens are always implicit and often missing in spoken languages. For example, units of ones and tens are not visible in ‘thirty-one’.

Examples in European languages show that many irregularities appear in their languages; they depend on the existence of more ancient representation (with non-ten bases) or on other linguistic properties where the combination of two words forces an abbreviation. Furthermore, the order of units may be different.²

In English, French and German, numbers have independent names up to 12, while in Italian the suffix *dici* appears with 11 and becomes a prefix with 17 (as in French). English and German are similar from 13 to 20 (with the suffix *teen* or *zehn*, meaning 10). But from 21 the order of reading units and tens in German is opposite to that in English until 99. In French there is the memory of base 20, e.g. 70 is *soixante-dix*; 80 is *quatre-vingts*. A similar yet more complex irregularity is present in Danish: the irregularity involves the number names between 10 and 20, the inversion of units and tens (as in German) and a memory of a base 20 system (see Chap. 5 and Ejersbo and Misfeldt 2015).

When expressing $76 + 83$, for example, different languages hint at different words that make the column calculation more or less difficult.

English: seventy-six plus eighty-three

French: sixty-sixteen plus four-twentys-three

Italian: seventy-six plus eighty-three

Danish: three-and-a-half-twenty-six plus four-twenty-three

Chinese: seven tens six plus eight tens three.

The transparency of the Chinese names is likely to foster students’ understanding of place value.

3.2.3 *Post-colonial Cases: Africa and Latin America*

Zaslavsky (1973) wrote her fundamental books on African mathematical tradition to contrast the scarce (if any) references to Africa in Menninger (1969). In a later study, Verran (2001) reports on the Yoruba approach to whole number arithmetic. At the Macao Conference, there were two scholars from Northern Francophone (Nadia Azrou) and South-Eastern Anglophone Africa (Veronica Sarungi) who reported on the story of whole number arithmetic in the schools in their postcolonial regions.

²Funghi (2016) prepared a review of many different languages.

3.2.3.1 Algeria

Azrou (2015) reports the language situation in Algeria, where many different languages are spoken with different status: classical Arabic, Berber and French together with many different local dialects (see Chaps. 5 and 15). Besides the different number words, Azrou reports the different meanings of ‘digit’ vs ‘number’. Consider the following examples:

A- 1,2,3,...,9

B- 2781

C- a series of digits to design a phone number, a car number and an address, e.g. the contact number for ICMI-49 30 20 37 24 30...

In English, A are called digits, B numbers and C numbers.

In Arabic, A are called رقم *raqm* (digit) or أرقام *arqam* (digits, the plural).

In French, A are called chiffres, B nombres and C numéro.

In Berber (Tamazight is one of the oldest languages of humanity), only one word (*numro*) is used for everything.

The relationship between the French dialect and Berber language (languages used in everyday life) presents a problem. The dialect and Berber language have kept one word (*numro*) to express everything. This is a problem for students, who confuse the mathematical concepts they learn at school (for both Arabic and French) with the street mathematics used in Berber in everyday life.

3.2.3.2 The Guatemalan Case

In Guatemala, the official language is Spanish, and the indigenous population comprises 41% of the total population. There are 25 linguistic communities grouped in 4 ‘pueblos’ (different groups of people), i.e. Ladino, Maya, Grifúna and Xinka, each with a unique identity, culture and language. Mayans comprise 81% of the indigenous population and have four linguistic communities. The formal recognition of the complex ethnic composition of this country was made in 1996 through the ‘Agreement of Peace’, which recognised people’s right to their cultural identities. As a consequence, the Ministry of Education set up a bilingual programme in which the teaching must be done bilingually, respecting the culture and values of the indigenous people. In 2005, there were 3800 bilingual schools, and many of their teachers could speak the indigenous language but could not write or read it. Because of the characteristics of this country, primary schools work with two number systems: vigesimal (base 20) for Mayan mathematics and decimal. Numbers are read and written according to the two systems and various languages. The Mayan numeration system uses three symbols: the dot to represent a unit (●), the bar to represent five units (▬) and a third symbol to represent the zero, also called a shell or cocoa bean (○). With the combination of these three symbols, the first 19 numbers are written using three rules. First, from one to four, points are combined. Second, five points form a bar. Third, bars are combined up to three.

3.2.3.3 Tanzania and Other East African Countries

Sarungi (personal communication) reports on the complex situation in the part of Africa colonised by the British Empire (East African countries). The diversity in learners' first languages makes teaching mathematics in those languages difficult. For example, Tanzania has over 120 ethnic tribes with their own languages, although these belong to major language groups such as Bantu, Nilotic and Cushitic. At the same time, Kiswahili, which is a mixture of Bantu, Arabic and other languages such as Portuguese and English, has become the first language of tribes along the coast and islands of Zanzibar. In fact, Kiswahili is the national language of Tanzania and Kenya and is widely spoken in other East and Central African countries such as Burundi, Rwanda, Uganda and Democratic Republic of Congo.

In Tanzania, the language policy is to use Kiswahili as the medium of instruction in pre-primary and primary education (MOEVT 2014), even though Kiswahili is not the first language of many children, especially those in rural areas (Halai and Karuka 2013) and is learnt formally when entering school. In Uganda, the policy is to use ethnic or local languages in the first 3 years of primary school, although English is used in settings in which learners have diverse local languages (National Curriculum Development Centre n.d.). Research conducted in African contexts has pointed to the challenges of using a language that is not easily accessible to learners and even teachers in some cases, while the use of first languages in mathematics classrooms has been shown to foster more interactions between learners and teachers (Sepeng 2014).

Apart from the benefits of increased participation, the names of numbers in ethnic languages usually point to a base 10 structure (see Funghi 2016). Most African languages have a similar structure for numbers between 10 and 20, namely, 'ten' and '*digit*', where *digit* stands for a number from one to nine inclusive. Moreover, the decades from 20 to 90 have a logical structure. The wording constitutes either 'tens *digit*' to signify how many tens are taken or 'decade *digit*', such as in Simbiti. Thus, a number like 34 in African ethnic language is literally formed as 'tens three and four' or mathematically 'three tens and four'. Many children encounter the names of numbers to around 30 in a non-formal way by the time they start attending school. Thus, learning whole numbers in such ethnic languages could help learners to make sense of the structure of the numbers. However, there are challenges in taking advantage of these affordances. First, teachers may not be equipped to assist learners, due to unfamiliarity with the local language and its mathematical register (Chauma 2012). Moreover, the language policy may not be favourable to promoting the use of ethnic languages, as is the case for Tanzania, where Kiswahili is encouraged for purposes of national unity.

When widely spoken in a community, Kiswahili can bridge the gap between the multiplicities of languages, although its use for learning whole numbers can be a potential source of confusion for children, even if it is their first language. This is due to the origins of number names from Arabic and Bantu words, which results in an inconsistency in the naming of decades (for a comparison between Awahili and Arabic, see Funghi 2016).

For Bantu speakers, numbers from 1 to 20 present little problem, except for the names of 6, 7 and 9. However, non-Bantu speakers have to learn most of the names, although the structure from 11 to 20 is familiar. For most learners, there is an additional cognitive demand in learning the names of decades, which no longer adhere to the structure of Bantu or other ethnic languages but instead borrow words from Arabic. For example, there is very little link between the names for 30 and 3. In effect, children are required to learn new names for 20, 30, 40 and 50 in Kiswahili. It is only 60, 70 and 90 that have some link to 6, 7 and 9, respectively. Thus, asking children to write down a given two-digit number in words can result in confusion if, for instance, the child needs to remember the name for 30 (*thelathini*) and cannot infer it from its name, which is linked to its value (three tens). On a related point, the use of English in private pre-primary schools in Tanzania further complicates the matter, as the structure of numbers from 11 to 19 does not follow the known structure of Bantu and Kiswahili. Ultimately, even in contexts in which both learners and teachers speak the same language as the language of instruction, it is important to take into account the features of the common language that hinder or promote the learning of whole numbers in early years of schooling.

3.2.4 *Towards Transparency: The Chinese Approach*

Chinese young children perform better at facets of basic arithmetic, such as generating cardinal and ordinal number names (Miller et al. 2000), understanding the base 10 system and the concept of place value (Fuson and Kwon 1992), using decompositions as their primary backup strategy to solve simple addition problems (Geary et al. 1993) and calculation (Cai 1998). A comparative study (Geary et al. 1992) indicates that the addition calculating scores of Chinese students is three times that of American students. Specifically, Chinese students use more advanced strategies and exhibit faster retrieval speeds. American students use counting strategies (e.g. counting fingers or verbal counting) more frequently than their Chinese counterparts. Chinese students use retrieval strategies more frequently than their American counterparts (He 2015). However, most studies have provided various explanations for these findings, such as parents' high expectations for education, the diligence of the students and the effectiveness of the teachers. Ni (2015) argues that elementary school curricula, textbooks, classroom instruction and the cultural values related to learning mathematics have contributed to the arithmetic proficiency of Chinese children and the establishment of arithmetic as a social-cultural system.

The 2013 PISA results in mathematics (from the test taken in 2012) showed that the highest performers were located in Asian countries, placing in the following order: (1) Shanghai (China), (2) Singapore, (3) Hong Kong (China), (4) Taiwan, (5) South Korea, (6) Macao (China) and (7) Japan. All of these countries have used languages that share the same ancient Chinese number tradition.

Some authors have studied the Chinese language and culture in mathematics education in the last few decades. For instance, ICMI Study 13 (Leung, Graf and

Lopez-Real (2006) first focused on a comparison of East Asia and the West. It was followed by a trend of studies and volumes about Chinese tradition in mathematics education (Fan et al. 2004, 2015; Li and Huang 2013; Wang 2013). The specific issue of language has been addressed by many authors such as Galligan (2001) and Ng and Rao (2010), and other authors such as Fuson and Li (2009) and Xie and Carspecken (2007) have compared educational materials in China and the USA.

This phenomenon relates to a large number of teachers and students. In China, there are nearly 2.63 hundred million primary school students. Moreover, the ancient Chinese literature affected the development of mathematics in most East Asian countries (e.g. Japan, Korea, Vietnam) (Lam and Ang 2004) in terms of the convention of place value.

3.3 The Chinese Approach to Arithmetic

3.3.1 *The Ancient History*

The Chinese approach to numerals in primary schools shows consistency among the features of Chinese language, the names of numbers and the use of artefacts for representing numbers and computing (Chap. 5), which can be traced back to the tradition of teaching numbers in China in fourteenth century BCE (Guo 2010). The long tradition is reflected in a range of ancient Chinese arithmetic works, such as the official mathematical texts for imperial examinations in mathematics used a thousand years ago:

The *Suàn shù shū*, *Writings on Reckoning* (算数书) (202–186 BCE)

Zhoubi Suanjing (周髀算经) (100 BCE)

The Nine Chapters on the Mathematical Art (九章算术) (100 BCE)

The Sea Island Mathematical Manual (海岛算经) (about 225–295 CE)

The Mathematical Classic of Sun Zi (孙子算经) (500 CE)

The Mathematical Classic of Zhang Qiujiang (张丘建算经) (500 CE)

Computational Canon of the Five Administrative Sections (五曹算经) (1212 CE)

Xia Houyang's Computational Canons (夏侯阳算经) (1084 CE)

Computational Prescriptions of the Five Classics (五经算术)

Jigu Suanjing (缉古算经) (625 CE)

Zuisu (缀术) (500 CE)

Shushu jiyi (数术记遗) (about 200 CE)

In this section, we offer a short outline of Lam and Ang's (2004) *Fleeting Footsteps*, a long history drawing on an important reference.

In the general history of numbers, the importance of the Chinese tradition is not always acknowledged. For instance, Ifrah (1981) claims that place value is an Indian invention. Dauben (2002) strictly criticises this error:

One Chinese source of which Ifrah is apparently unaware is the *Sun Zi Suanjing* 孙子算经 (The Mathematical Classic of Sun Zi), written around 400 CE. (p. 37)

This text has been available in an English translation since 1992 in *Fleeting Footsteps*, an edition prepared with extensive commentary by Lam and Ang, who later published a more extended edition (Lam and Ang 2004). This source not only gives a complete description of Chinese rod numerals, but also describes in detail ancient procedures for arithmetic operations. The most ambitious part of Lam and Ang's study argues that the Hindu-Arabic number system had its origins in the rod numeral system of the Chinese. The most persuasive evidence Lam and Ang offer is the fact that the complicated, step-by-step procedures for carrying out multiplication and division are identical to the earliest but later methods of performing multiplication and division in the West using Hindu-Arabic numerals, as described in the Arabic texts of al-Khwārizmī, al-Uqlīdisī and Kūshyār ibn Labbān (see the extensive review in Lam and Ang 2004). Guo (2010) explains that the Chinese system was transmitted to India during the fifth to ninth centuries, to the Arabic empire in the tenth century and then to Europe in the thirteenth century through the Silk Road. In 1853, Alexander Wylie, Christian missionary to China, refuted the notion that 'the Chinese numbers were written in words at length' and stated that in ancient China calculation was carried out by means of counting rods and that 'the written character is evidently a rude presentation of these', showing both the arithmetic procedure and the decimal place value notation in their numeral system through the use of rods. Wylie believed that this arithmetic method invented by the ancient Chinese played a vital role in the advancement of all fields that required calculations. After being introduced to the rod numerals, he wrote:

Having thus obtained a simple but effective system of figures, we find the Chinese in actual use of a method of notation depending on the theory of local value [i.e. place value], several centuries before such theory was understood in Europe, and while yet the science of numbers had scarcely dawned among the Arabs. (p. 85)

In a review of the first edition of the *Archives internationales d'histoire des sciences*, Volkov (1996) writes that the book 'may provoke a strong reaction from historians of European mathematics'. Nevertheless, Volkov emphasises one of the book's great strengths:

The emphasis made by the authors on the great importance of studying Chinese methods of instrumental calculators as well as numerical and algorithmic aspects of Chinese mathematics, which otherwise cannot be understood properly. (p. 158)

Chemla (1998) suggests adopting a prudent attitude towards this controversy:

The *nine chapters* share with the earliest extant Indian mathematical writing (6th c.) basic common knowledge, among which is the use of a place-value decimal numeration system. Such evidence allows no conclusion as to where this knowledge originated, a question which the state of the remaining sources may prevent us forever answering. Instead, it suggests that, from early on, communities practicing mathematics in both areas must have established substantial communication. (p. 793)

This historic origin could be helpful for understanding why the Chinese (Eastern individuals) have found it so easy to grasp this concept, why it is so late to develop in Europe, how number heritage has been shaped and how we can advise on the

number practices or tools used to strengthen the comprehension of place value. In the following, we elaborate on the Chinese approach to arithmetic as representative of East Asia. We begin by considering some elements of the Chinese approach to numbers and computation and then discuss some of the educational implications.

Although ancient Chinese mathematicians did not develop a deductive approach, they made advances in inductive algorithm and algebra development (Guo 2010). The *Zhoubi Suanjing* (周髀算經), the oldest complete surviving mathematical text compiled between 100 BCE and 100 CE, contains a statement highlighting the analogy nature of Chinese tradition:

In relation to numbers, you are not as yet able to generalize categories. This shows there are things your knowledge does not extend to, and there are things that are beyond the capacity of your spirit. Now in the methods of the Way [that I teach], illuminating knowledge of categories [is shown] when words are simple but their application is wide-ranging. When you ask about one category and are thus able to comprehend a myriad matters, I call that understanding the Dao. ... This is because a person gains knowledge by analogy, that is, after understanding a particular line of argument they can infer various kinds of similar reasoning ... Whoever can draw inferences about other cases from one instance can generalize. (Quoted in Cullen 1996, pp. 175-176)

Since antiquity, the major focus of Chinese mathematics has been on numbers and computations as collections of prescriptions similar to modern algorithms. Mathematics is called *shùxué* 数学 (“shù” meaning ‘number’) in Chinese. Knotted cords and tallies (see Sect. 9.2.2) were mentioned in ancient Chinese literature (Martzloff 1997, p. 179), following multiplicative-additive rules. The Chinese used bamboo rods to count (see the information about counting rods in Sect. 9.2.2), and this activity fostered the creation of a systematic way to represent numbers. The first nine numerals formed by the rods are presented in Fig. 3.1.

According to Lam and Ang (2004), the number presentation principle was initially introduced as follows:

Numerals in tens, hundreds and thousands were placed side by side, with adjacent digits rotated, to tell each apart. For example, 1 was represented by a vertical rod, but 10 was represented by a horizontal one, 100 by a vertical one, 1000 by a horizontal one and so forth. Zero was represented by a blank space so the numerals 84,167 and 80,167 would be as shown [see Figure 3.2]. ... Although most books on the early history of mathematics, especially the recent ones, have mentioned the Chinese rod numerals, they have failed to draw attention to a very important fact that the ancient Chinese had invented a positional NOTATION. Any number, however large, could be expressed through this place value notation which only required the knowledge of nine signs. I should add that in the current

Fig. 3.1 The Chinese Rod representation of the first nine numerals



Fig. 3.2 Rod representation of multi-digit numbers



Fig. 3.3 An ancient drawing of a *suàn pán* (算盘) with measurement units (https://commons.wikimedia.org/wiki/File:Ming_suanpan.JPG)

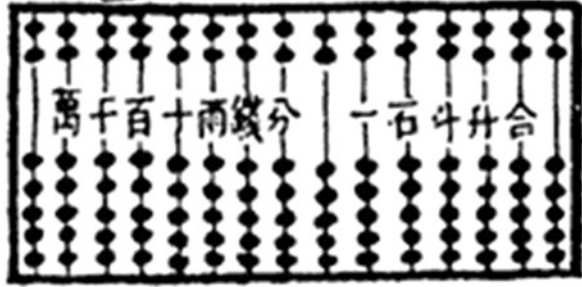

more sophisticated written form, a tenth sign, in the form of zero, is required (Lam and Ang 2004, p. 1)

The translation of the computation principle was initially introduced as follows:

In the common method of computation [with rods] (*fán suàn zhī fǎ*, 凡算之法), one must first know the positions (*wèi*, 位) [of the rod numerals]. The units are vertical and the tens horizontal, the hundreds stand and the thousands prostrate; thousands and tens look alike and so do ten thousands and hundred. (Lam and Ang 2004, p. 193)

A feature of Chinese mathematics is the ancient use of the counting rods (算筹, *suàn chóu*) on a table (counting board, *jìshù bǎn*, 计数板, Fig. 3.3). The counting board was used to make computations (arithmetic operations, extracting roots) and solve equations. The rules for using the counting board are carefully described by Lam and Ang (2004), who highlight the feature of introducing procedures in pairs: the procedure for subtraction is the inverse of that for addition, and the procedure for division is the inverse of that for multiplication. Chemla (1996) highlights that the position in the counting board is stable (see Sect. 3.3.4, which reports on the wording of the elements of arithmetic operations).

3.3.2 Chinese Language Foundation to Place Value

The concept of place value is dominantly used in counting rod or *suàn pán* (算盘) and written numerals (Sun 2015). Moreover, place value can be traced to the use of base 10 and conversion rates for measurements, classifier grammar and the part-part-whole structure with radicals and characters in local language. This language origin can be helpful in understanding why Western students find it so difficult to grasp the concept of place value and why it has developed so late in Europe from a language perspective.

3.3.2.1 Base 10 and the Conversion Rate for Measurement

The Chinese system had a base 10 convention for representing quantities (Lam and Ang 2004; Martzloff 1997; Sun 2015). This was consistent with the conversion rate between the measurement units of length and volume, since the first emperor (*qin*

shi huang 秦始皇) who unified the whole of China in third century BCE introduced a metric system for measurements.³ Except for weight units, units of length and volume had base 10 conversion rates. For example, the conversion rate of length units was expressed as follows (Lam and Ang 2004):

1 *yin* (引) = 10 *zhang* (丈) = 100 *chi* (尺) = 1000 *cun* (寸) = 10,000 *fen* (分) = 100,000 *li* (釐) = 1,000,000 *hao* (毫).

The conversion rate of weight units was:

1 *liang* (两) = 10 *qian* (钱) = 100 *fen* (分) = 1000 *li* (釐) = 10,000 *hao* (毫) = 100,000 *si* (丝).

The conversion rate of volume units was:

1 *gong* (斛) = 10 *dou* (斗); 1 *dou* (斗) = 10 *sheng* (升).

The ancient conversion rate of time units was 100 before the Western Zhou dynasty:

1 *shi* (时) = 100 *ke* (刻); 1 *night* (晝夜) = 5 *geng* (更).

The first money conversion rate was 10 in ancient China:

1 *peng* (朋) = 10 *ke* (具).

Besides the measurement unit systems, the Chinese system had a base 10 convention for representing numerals using number characters and corresponding number units (Zou 2015). This can be ascribed to the Yellow Emperor in the sixth century book by Zhen Luan, *Wujing suanshu* (五經算術 Arithmetic in Five Classics) (Guo 2010). The first five number units, i.e. *ge* (個), *shí* (十), *bǎi* (百), *qiān* (千) and *wàn* (萬), always represent 1, 10, 10², 10³ and 10⁴, respectively. The other number units vary with different systems of number notation.

Shushu jiyi 《数术记遗》 written by XuYue (徐嶽) during the Eastern Han dynasty (50–200 CE) recorded the early number naming principle: the conversion rate of the down number (*xiashu* 下数), i.e. the standard number, was 10; the conversion rate of the middle number (*zhongshu* 中数), i.e. the large number, was 10,000; and the conversion rate of the up number (*shangshu* 上数), i.e. the largest number, was the square of the number unit.

Looking at decimal and fraction numbers, the following spoken numeration units were used to denote small orders of magnitude in Sunzi Suanjing (Lam and Ang 2004) in ancient China. The negative power of 10 was stressed in daily spoken numerals: 10⁻⁴ 絲 *si*, 10⁻³ 毫 *hao*, 10⁻² 釐 *li* and 10⁻¹ 分 *fen*.

³It may be interesting to compare the situation in China with the situation in Europe, where the metric system was introduced at the end of the eighteenth century, and the situation in the USA and UK, where metricisation is still controversial. For example, the conversion rates of inches, feet, yards and miles are non-10: 12 inches = 1 foot, 3 feet = 1 yard, 5280 feet = 1 mile. One US fluid ounce is 1/16 of a US pint, 1/32 of a US quart and 1/128 of a US gallon.

3.3.2.2 Classifiers

All number units in the Chinese language are called *classifiers* (*Liàngcí* 量詞). In English, it is natural to use measurement words to describe the quantity of a continuous noun (i.e. to identify a specific unit to make the quantity countable). For example, in 1 m of cloth, 1 ml of water and 1 kg of meat, the measurement units of m, ml and kg are, respectively, required. However, it is natural not to use measurement words to describe the quantity of countable nouns (e.g. one apple, five ducks and three desks). There are hundreds of different classifiers, all of which reflect the objects to be counted. In Chinese, both uncountable and countable nouns need measurement words known as classifiers. Consider one *ge* (個) apple, five *zhi* (只) ducks and three *zhang* (張) desks, in which *ge* (“unit of fruit”), *zhi* (“unit of animal”) and *zhang* (“unit of object”) play the role of measurement word as units. This is a kind of Chinese grammar used to describe quantity (數量), which requires numbers and classifiers. The classifiers are called number units (Zou 2015), numeration units (Houdement and Tempier 2015), number ranks (Lam and Ang 2004) or number markers (Martzloff 1997).

The column units left of the *suàn pán* (算盤) shown in Fig. 3.4 read from left to right as follows:

Wan (萬 ten thousand), *qian* (千 thousand), *bai* (百 hundred), *shi* (十 ten), *liang* (兩 weight unit 1 *liang* = 1/16 jin), 錢 *qian* (10 *qian* = 1 *liang*), 分 *fen* (weight unit, 10 *fen* = 1 *qian*).

The column units right of the *suàn pán* shown in Fig. 3.4 read as follows from left to right:

一 ones, 石 *shi* (volume unit, 10 *dou* = 1 *shi*); 斗 *dou*, 升 *sheng*, 合 (1 斛 = 10 斗, 1 斗 = 10 升, 1 升 = 10 合).

The units are used as column units. Weight, volume and numeration units have the same position in a functioning calculation. This indicates that numeration units have the same role as that of measurement units in Chinese (Martzloff 1997).

Fig. 3.4 The number 71,824, written by the mathematician Jia Xian during the Song dynasty (960–1279)

七 一 八 二 四
萬 千 百 十 步
卅 一 卅 二 卅

一个、二个、; 一十一个、 一十二个、; 二十个, 二十一个....

Fig. 3.5 The oral counting in Chinese. One ones, two ones ...; ten ones, one ten and one ones, one ten and two ones, ...; two ten ones, two tens and one ones ...

Following Allan (1977), there are about 50 languages in the world with this feature, some in the Far East and some in other parts of the world. We discuss the case of the Chinese language, where numeral classifiers are systematically used, in detail as follows. Following Senft (2000), numeral classifiers are defined in the following way:

In counting inanimate as well as animate referents the numerals (obligatorily) concatenate with a certain morpheme, which is the so called ‘classifier’. This morpheme classifies and quantifies the respective nominal referent according to semantic criteria. (p. 15)

There are many classifiers in Chinese, as each type of counted object has a particular classifier associated with it. This is a weak rule, as it is often acceptable to use the generic classifier (*gè*, 个) in place of a more specific classifier. The generic classifier (*gè*, 个) is not translated into English, but may be considered as a kind of unit (a ‘one’). The generic classifier may be considered the prototype of units in place value representation.

Besides the generic classifier (*gè*, 个), other units of higher value have been introduced in Chinese to represent numbers: ten (*shí* 十), hundred (*bǎi* 百), thousand (*qiān* 千) and ten thousand (*wàn* 万). A very interesting example from ancient Chinese is given in Figure 1 in the *Yongle Encyclopedia* (1408).⁴ In the example shown in Fig. 3.4, the number 71,824 is represented to indicate the digit and number (or measurement) unit. In this case, the unit is 步 (*bù*, i.e. step, an ancient length unit).

In particular:

- The first line ‘七一九四二’ represents the number value ‘71,824’.
- The second line represents the units 萬 (*wàn*, ten thousand), 千 (*qiān*, thousand), 百 (*bǎi*, hundred), 十 (*shí*, ten) and 步 (*bu*, or ‘step’, an ancient length unit).
- The third line represents the number using the ancient rod numerals, hinting at the counting rods discussed previously. The number units have the same position as the measurement unit (bu).

Classifiers are used also in the recitation of numerals when counting objects, so that both oral and written numerals are kept consistent with each other.

In Fig. 3.5, ten-two hints at an addition procedure of $10 + 2$, while two tens hints at a multiplication procedure of 2×10 . Hence, the Hindu-Arabic number 24 is translated into the Chinese language as ‘two tens and four ones’ (二十四个).

The legend shows a literal translation into English (numeral and classifier). In the translation, there is ambiguity between one (number) and one (classifier or unit),

⁴https://en.wikipedia.org/wiki/Yongle_Encyclopedia. See also <http://www.wdl.org/en/item/3019/>

which in Chinese are written (一, 个) and said (yī and gè) in two different ways. The same happens for 10, which in English is both a number and a unit.

In other languages (e.g. Italian), the situation may be less ambiguous, as ‘uno’ and ‘dieci’ (numbers 1 and 10) are different from ‘unità’ and ‘decina’ (unit), but the use of terms like the latter in the reading of numbers is limited to school practice (decomposition of a given number in unit, ten, hundred and so on).

In Chinese, classifiers are also used in interrogative questions, e.g. 多少 (*duōshǎo*), which means ‘How much? How many?’, and the right classifier must follow. When this term is used in an arithmetic word problem, e.g. in additive problems, the same classifier is used for both the data and question. For example, if five *zhi* (只) ducks swim in a river, and then two *zhi* (只) ducks join them, how many *zhi* (只) ducks are there altogether? This example shows that *zhi* (只) must be used for both the data and question.

By identifying classifiers of quantity, concrete numbers with units of the same name (same classifiers) are defined *like numbers* (see Chap. 18 of this volume). A principle for arithmetic operations with like numbers is also constructed in everyday language (see Chap. 18 of this volume).

Principle of addition/subtraction: only like numbers can be directly added or subtracted. Two *zhi* (只) ducks can be added to three *zhi* (只) ducks. Two *zhi* (只) ducks cannot be added to three dozen *da* (打) or groups of ducks.

Principle of multiplication: only unlike numbers can be directly multiplied. For example, three groups of *zhi* (只) ducks swim at the river. Each group comprises four *zhi* (只) ducks. How many *zhi* (只) ducks are there in total? The answer is 4 *zhi* (只) ducks * 3 groups = 12 *zhi* (只) ducks.

Principle of division:

- *With like numbers (measure division)*: for example, 12 *zhi* (只) ducks swim in the river. Each group comprises four *zhi* (只) ducks. In this case, 12 and 4 are like numbers. How many groups are there in total? The answer is 12 *zhi* (只) ducks/4 *zhi* (只) ducks = 3 groups.
- *With unlike numbers (partitive division)*: for example, 12 *zhi* (只) ducks swim in the river. We plan to group them into three groups. Here, 12 and 3 are unlike numbers. How many *zhi* (只) ducks are in each group? The answer is 12 *zhi* (只) ducks/3 groups = 4 *zhi* (只) ducks per group.

Classifiers are one of the most important elements required in word problem-solving. Generally, Chinese curricula do not need a section to differentiate partitive division from measure division, as the grammar of classifiers is enough to introduce the distinction.

3.3.2.3 Radicals and the Part-Part-Whole Structure

Radicals (部首 *bù shǒu* ‘section headers’) constitute the basic writing unit. Most (80–90%) of Chinese characters are phonetic-semantic compounds, combining a semantic radical with a phonetic radical. Chinese words have a compound or

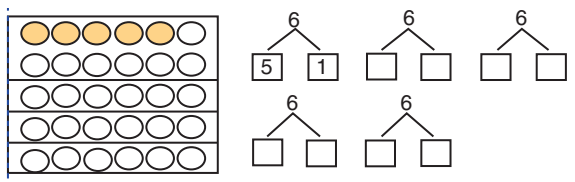

Fig. 3.6 The decomposition of 6 in many different ways as $5 + 1$, $4 + 2$ and so on (Mathematics Textbook Developer Group for Elementary School 2005, p. 42)

part-part-whole structure. The compound can be seen in the structure of Chinese number words. For example, as shown previously, the Chinese refer to the number 12 as ‘ten-two’ rather than as a single word such as ‘twelve’.

The idea of a part-part-whole structure appears in a more general way in number computations. A number (a whole) may be conceived as the sum of two parts in different ways (see Fig. 3.6).

This idea may be connected with the use of artefacts (either counting boards *jìshù bǎn*, 计数板 with rod numerals 算筹; *suàn chóu* or *suàn pán* 算盘). For instance, in the *suàn pán*, it is important to ‘make a ten’ by replacing two groups of five beads with one bead in the tens place if one has to calculate the following while also exploring the associative and commutative properties of addition:

$$15 + 7 = (10 + 5) + (5 + 2) = 10 + 5 + 5 + 2 = 10 + 10 + 2$$

The practice of composing/decomposing numbers is exploited to carry out very fast calculations (for a didactical example, see Chap. 11, Sect. 11.2).

3.3.3 Conceptual Naming of Fractions

The Nine Chapters on the Mathematical Art (九章算術; *Jiǔzhāng Suànshù*) was composed by several generations of scholars from the tenth to second century BCE, with its latest stage composed from the second century CE. According to Guo (2010), it gave the first fraction theory in the world. These are the procedures called *he fen* (addition 合分: Problems 7–9), *jian fen* (subtraction 減分: Problems 10–11), *ke fen* (comparison 課分: Problems 12–14), *ping fen* (arithmetic mean 平分: Problems 15–16), *cheng fen* (multiplication 乘分: Problems 19–25) and *jing fen* (division 經分⁵: Problems 17–18) (Sun and Sun 2012).

Martzloff (1997) observes, ‘In Chinese mathematics, by far the most common notion of fraction is that which comes from the notion of dividing a whole into an equal number of equal parts (sharing)’ (p. 192). He quotes examples such as 三分之二 (*sān fēn zhī èr*), meaning ‘two thirds’. The word 分 (*fēn*) suggests the idea of

⁵Like 經分 in *The Nine Chapters on the Mathematical Art*, in ancient times, 徑 and 經 were regarded as the same word.

sharing, as etymologically its upper component *bā* (八) means ‘to share’, while its lower component represents a knife (刀, *dāo*). The order of reading (and writing) is denominator first and numerator second and may be literally translated as ‘of three parts, one’. Martzloff (1997) continues:

The denominator and the numerator are then respectively called *fēn mǔ* (分母 the ‘mother’ of the sharing) and *fēn zǐ* (分子 the ‘son’ of the sharing). The inventor of these expressions was thinking of a pregnant mother and her child, thus highlighting both the difference in size and the intimate link between the two terms. (p. 103)

According to Needham and Wang (1959) and Guo (2010), decimal fractions were called tiny numbers (微數 *wēi shù*), first developed and used by the Chinese in first century BCE by Liuhui (劉徽) (Guo 2010).

3.3.4 Arithmetic Operations

Here, we explain how addition and subtraction were introduced into Chinese tradition. The links between addition and subtraction were highlighted in the ancient textbooks. In 1274, Yang Hui observed, ‘Whenever there is addition there is subtraction’ (quoted in Siu 2004, p. 164).

This strict link is evident in the wording of operations. The strong regularity is evident in the following list:

加 – *jiā* – addition.

加数 – *jiā shù* – addend.

減 – *jiǎn* – subtraction.

減数 – *jiǎn shù* – subtrahend, literally ‘subtracting number’.

被減数 – *bèi jiǎn shù* – minuend, literally ‘subtracted numbers’.

乘法 – *chéngfǎ* – multiplication.

被乘数 – *bèi chéng shù* – literally ‘multiplied number’.

乘数 – *chéng shù* – literally ‘multiplying number’.

除法 – *chúfǎ* – division.

被除数 – *bèi chú shù* – dividend, literally ‘divided number’.

除数 – *chúshù* – divisor, literally ‘dividing number’.

被 (*bèi*) is the most common word used in Chinese to create the passive verb form.

This regularity is meaningful, especially when compared with the wording in Western languages. Schwartzman (1994) points out that many English mathematics terms are borrowed from Greek and that Latin-derived terms bear no inherent meaning. For example, the English words ‘minuend’ and ‘subtrahend’, which come from Latin words and thus have little meaning today for English-speaking children in contrast with Chinese subtracted and subtracting numbers, directly embody the subtraction relationship without the exchange law. (The same is true in other Western languages.)

Addition and subtraction are carried out using counting rods (算筹 *suàn chóu*) (see Sect. 9.2.2) by simply grouping (組合 *zǔhé* making the bundle) or ungrouping

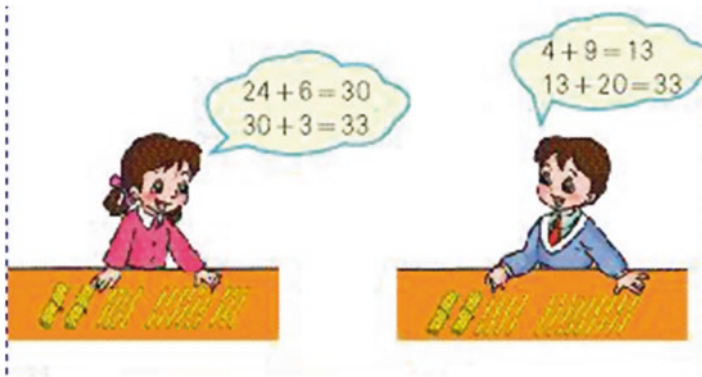

Fig. 3.7 Addition in the Chinese textbook (Mathematics Textbook Developer Group for Elementary School, 2005, vol. 2, p. 62.)

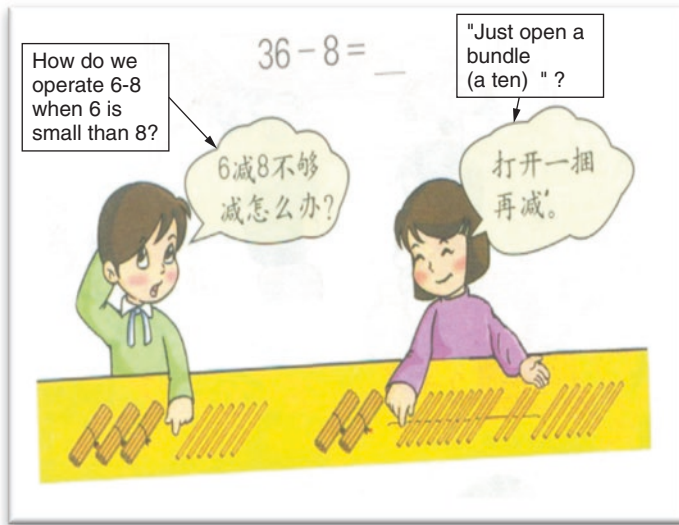

Fig. 3.8 Subtraction in the Chinese textbook (Mathematics Textbook Developer Group for Elementary School, 2005, vol. 2, p. 68.)

(解组 *jiě zǔ* opening the bundle) the rods (see Figs. 3.7 and 3.8) (Mathematics Textbook Developer Group for Elementary School 2005).

When the abacus (*suàn pán* 算盘) is introduced, fingering is complex (Fig. 3.12) and wording may become different (Fig. 3.10):

进一 – *jìn yī* – forward (towards the unit of higher value, e.g. when 10 units becomes a ten

退一 – *tuì yī* – backward (towards the unit of lower value, e.g. when a ten becomes 10 units

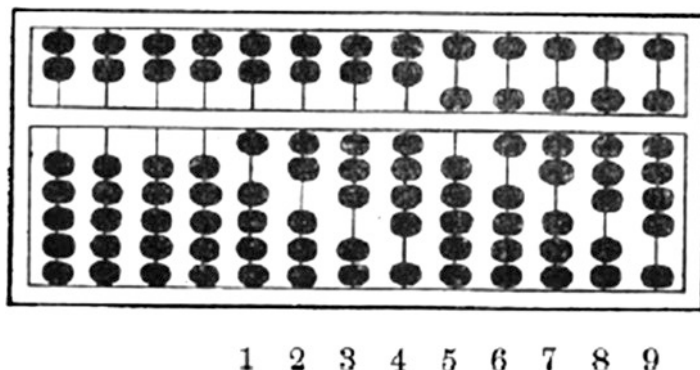
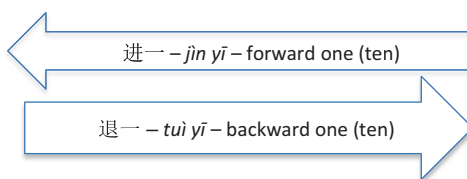

Fig. 3.9 Representation of 123456789 in a Chinese *suàn pán* (Kwa 1922, p. 6)

Fig. 3.10 Wording on *suàn pán*: forward and backward



The following images are taken from Kwa (1922), an old handbook of the Chinese abacus that was included as a gift for participants at the Macao Conference.

These features are interesting, as in both cases they emphasise the inverse relation between addition and subtraction, which are described by means of inverse verbs. Division is based on multiplication, as it is the inverse of multiplication and uses a scheme that is symmetric with respect to the multiplication performed in rod calculations (adapted from Martzloff 1997, p. 217) (Table 3.1).

We analyse the differences from Western languages where this link is not highlighted as follows.

3.3.5 Mathematical Relational Thinking: Equality

A range of studies has advised emphasising not only numerical computation but also quantitative relationships (Ma 2015; Bass 2015; see also Chaps. 6 and 9 of this volume). The relational thinking of equality constitutes a central aspect of equations and algebra thinking (Cai and Knuth 2011). Equality is a key concept, but sometimes problems are presented in Western curricula. Li et al. (2008) show that Chinese curricula introduce the equal sign in a context of relationships and interpret the sign as ‘balance’, ‘sameness’ or ‘equivalence’. In the following, we review the history of the equal sign and address the approach to the relational view of the equal sign and equality.

Table 3.1 The symmetric scheme in *Sunzi Suanjing*

Multiplication	Multiplication	Division	Position
Multiplicand	Multiplier	Quotient (<i>shang</i> 商)	Upper
Product	Product	Dividend (<i>shi</i> 實)	Central
Multiplier	Multiplicand	Divisor (<i>fa</i> 法)	Lower

3.3.5.1 The History of the Equal Sign ‘=’ in Europe

The equal sign (=) was invented (and used in its relational meaning) in 1557 by Welsh mathematician Robert Recorde (in his work *The Whetstone of Witte*), who was fed up with writing ‘is equal to’ in his equations. He chose the two lines because ‘no two things can be more equal’ (Cajori 1928, p. 126).

The etymology of the word ‘equal’ is from the Latin words ‘aequalis’ (meaning ‘uniform’, ‘identical’ or ‘equal’) and ‘aequus’ (meaning ‘level’, ‘even’ or ‘just’).

The symbol ‘=’ was not immediately popular. The symbol ‘||’ was used by some, and ‘æ’ (or ‘œ’), from the Latin word ‘aequalis’ meaning ‘equal’, was widely used into the 1700s.

3.3.5.2 The History of the Equal Sign ‘=’ in China

It seems there was no ancient symbol for ‘=’ in Chinese, but the Chinese characters 等 *děng* (equality) for relational meaning and 得 *dé* (get the result) for procedural meaning were used broadly in ancient texts. Equality is related to the balance rule of *yin-yang* and the invariant principle of the *I Ching*. The basic procedures of *substituting* in the Chinese rod/*suàn pán*, *substituting 5 by 5 ones, substituting two 5s by 10, substituting 10 by 1 ten, substituting 100 by 10 tens, substituting 1 thousand by 10 hundreds*, etc., reflect the spirit of equality used in a broader, flexible way to some extent.

Such is the fundamental ancient Chinese mathematics spirit. ‘Simultaneous equations’ appears as one of the nine chapters of *The Nine Chapters on the Mathematical Art* (九章算术; *Jiǔzhāng Suànshù*) (Guo 2010). Spirit of equality is reflected in the ‘equalising’ and ‘homogenising’ theory (齐同原理), the first basic principle to deduce fractions, and ‘cutting and paste’ theory (割补原理), an explicit principle used when solving geometry problems involving area and volume in Liuhui’s commentary on *The Nine Chapters* (Guo 2010).

There are 256 instances of the character 得 (*dé*) and 11 instances of the character 等 (*děng*) in *The Nine Chapters*. The fifth problem in 方田 *fangtian* – rectangular fields – reads as follows:

The method for simplifying parts: What can be halved, halve them. As for what cannot be halved, separately set out the numbers for the denominator and numerator. Then alternately reduce them by subtraction. This is seeking for the *equality*. Simplify using this *equal* number. (Guo 2010, p. 99)

Fig. 3.11 Comparing numbers in the first grade: the prior content of the textbook (Mathematics Textbook Developer Group for Elementary School 2005, p. 5)

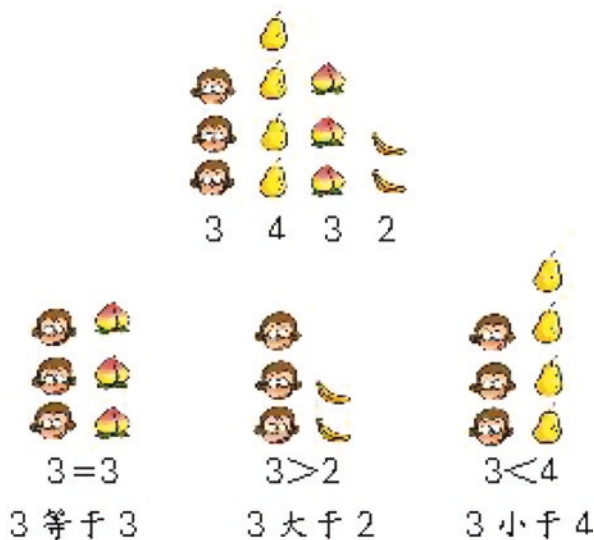
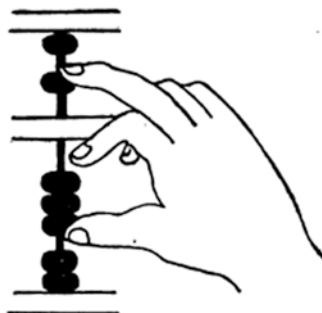

Fig. 3.12 Fingering in *suàn pán*: the correct method of moving the beads (Kwa 1922, p. 8)



3.3.5.3 Chinese Approaches to the Relational Meaning of Equality

Ni (2015) reports that Chinese teachers are intolerant of errors where the relational (or conceptual) meaning of ‘=’ is replaced by a procedural (or operational) meaning, while US teachers consider such errors minor. She mentions Chinese textbooks in which one-to-one correspondence is used from the beginning to assist students in better understanding the equal, greater-than and less-than symbols to enhance the relational meaning of ‘=’ in contrast with ‘<’ and ‘>’ (Fig. 3.11).

This strategy is widespread in other countries (Alafaleq et al. 2015).

In general, the English expression ‘how many’ is translated into Chinese as ‘more or less’ (*duōshǎo*, 多少), which hints at the relational meaning and denotes a comparison of more than or less than (the imagined number). This expression is very common in arithmetic word problems. Like numerals, such expressions need a classifier (Sect. 3.3.2.2), highlighting the explicit connection between data and unknown values.

The variation approach to word problems presents another way to cope with the conceptual meaning of equality in China. Variation (变式, *biàn shì*) is a widely used approach that aims to discern the variance, invariance and sameness behind a group of problems and is regarded as the foundation of algebraic thinking and equations (Sun 2011, 2016). This approach is also closely related to the features of the Chinese language. Chinese is a tonal and logographic language, where each character has multiple meanings (一詞多義) and each word plays multiple roles in its context (一詞多性). Teaching by variation is consistent with the needs of teaching the Chinese language. To learn to write Chinese and to increase their orthographic awareness, students must distinguish the similarities and differences of different characters that very often look similar to each other (Marton et al. 2010).

As variation problems enhance perceptions of variance and invariance or equality to solve word problems in Chinese curricula, they are regarded as one of the most important and explicit task design frameworks in China (Sun 2016). They refer to the ‘routine’ daily practice commonly accepted by Chinese teachers (Sun 2007, 2011; see also Cai and Nie 2007). Following Sun (2011), Bartolini Bussi et al. (2013, p. 550) describe a typical feature of these problems:

One distinctive feature of word problems is to develop the ability to identify the invariant category of word problems (识类) it belongs to and discern different categories (归类), namely, discern the invariant elements from the variant elements between problems and recognize the ‘class’ every problem belong to. This pedagogy is generally called as *biànshì* (变式) in Chinese, where ‘biàn’ stands for ‘changing’ and ‘shì’ means ‘form’, can be translated loosely as ‘variation’ in English (Sun 2011). Some categories of *biànshì* are the following:

OPMS (One Problem Multiple Solutions), where, for instance, the operation to solve the problem is carried out in different ways, with different grouping and ungrouping: $8 + 9 = (8 + 2) + 7$; $8 + 9 = 7 + (1 + 9)$ and so on.

OPMC (One Problem Multiple Changes, see the variation problem below in Italy (Bartolini Bussi et al. 2013)), where in the same situation some changes are introduced.

MPOS (Multiple Problem One Solution), where the same operation can be used to solve different problems, as in summary exercises (Sun 2011).

Western curricula use various models (e.g. models of taking away and comparing) to introduce meanings of addition/subtraction, as well as strategies to solve word problems. On the contrary, in Chinese curricula, rather than approaching word problems separately, problem variation permits them to be introduced in a holistic way without the use of multiple models (Sun 2015). Cai and Nie (2007, p. 467) report on the frequency of teaching with variation in the Chinese classroom through a survey of 102 teachers (see Table 3.2).

Table 3.2 The frequency of teaching with variation in the Chinese classroom

	Used very often	Used occasionally	Never used
OPMS ($n = 102$)	84	18	0
OPMC ($n = 102$)	69	33	0
MPOS ($n = 100$)	52	48	0

An example of OPMS of addition with two digits is discussed in Chap. 11. Section 3.4.5.2 considers a transposition of additive variation problems to Italy.

3.4 Educational Implications

The above observations clearly point out some of the features of the Chinese arithmetic tradition:

- The inductive approach, where general principles of representing numbers and calculation are consistent with and derived from the specific case of the ones place (e.g. number operations in the tens/hundreds place are similar to number operations in the ones place).
- The tradition of calculation using specific cultural artefacts that also leave traces in the language.
- The variation tradition in word problems.

These features have important educational implications. Ma (1999) finds that the content knowledge of American and Chinese teachers is different. In particular, the strength of mathematics content knowledge is related to profound understanding of fundamental mathematics. According to Ma (1999):

The US teachers tended to focus on the particular algorithm associated with an operation, for example, the algorithm for subtraction with regrouping, the algorithm for multi-digit multiplication, and the algorithm for division by fractions. The Chinese teachers, on the other hand, were more interested in the operations themselves and their relationships. In particular, they were interested in faster and easier ways to do a given computation, how the meaning of the four operations are connected, and how the meaning and the relationships of the operations are represented across subsets of numbers – whole numbers, fractions, and decimals. When they teach subtraction with decomposing a higher value unit, Chinese teacher start from addition with composing a higher value unit. (p. 112)

Similar reflections may be applied to other Western curricula. Chinese curricula do not have a chapter on place value similar to American or European curricula; rather, place value appears in all chapters, along with reading and writing number activities as an overarching principle. Place value involves implicit core knowledge of the number unit in ancient literature (Zou 2015) and in Chinese curricula (Sun 2015), which is different from the calculation vocabulary or extended number procedures in chapters on calculation in the mandatory practices of American curricula (Howe 2011, 2015).

3.4.1 *Place Value and Whole Number Operations*

Chinese verbal counting is transparent and completely regular for place value representation. However, in the West, place value may be perceived as an artificial construct for written purposes, as communities do not use it in ordinary

conversation; for Western students, it can be a learned concept, but not a native one. The abbreviation of ‘-teen’ numbers in English (13 to 19) and in other European languages cannot be easily decoded in terms of the place value of tens and ones, which hinders understanding of the ten-structured regroup aspects of a multi-digit calculation, i.e. addition with moving up a place/subtraction with moving back a place. This is consistent with the findings of Ho and Fuson (1998), who argue that the structure of the English language makes it more difficult to understand that ‘-teen’ numbers are composed of a ten and some ones. It also makes it more difficult to learn the advanced make-a-ten method of single-digit addition and subtraction that is taught to first graders in China and other East Asian countries (Fuson and Kwon 1992; Geary et al. 1993; Murata 2004; Murata and Fuson 2001, 2006). Actually, the positional and decimal principles mentioned in Chap. 5 (WG1) have been naturally embedded in Chinese numeration and everyday language since the third century BCE. Some scholars (e.g. Butterworth 1999) have interpreted this as a reason why Chinese students are at ease with place value for large numbers from the beginning. From ancient times until now, spoken Chinese whole numbers have been the same as written numbers, implying that the written numeral directly reflects its pronunciation and thus has not diverged from the spoken language. Place value is an unlearned activity, but it is an inherited concept like a mother language, where native speakers are often unaware of the complexities of their language. This may explain why all current Chinese curricula do not include the topic of place value (for a discussion, see Sect. 15.3).

3.4.2 Cardinal Numbers and Measure Numbers

From a conceptual perspective of numbers, Bass (see Chap. 19) points out that numbers and operations have two aspects: conceptual (what numbers are) and nominal (how we name and denote numbers). At least two possible pathways exist for the development of whole numbers: counting and measurement. Conceptually, numbers arise from a sense of quantity of some experiential species of objects: count (of a set or collection), distance, area, volume, time, rate, etc. To develop a conceptual understanding, Bass supports an approach to developing concepts of numbers using general notions of quantity and their measurement, in which the measurement ‘unit’ is key to knowing how much (or many) of the unit is needed to constitute the given quantity while measuring one quantity by another. Cardinal and measure numbers in Western languages appear very different from each other, as measure numbers require the choice of a unit. This is not the case in the Chinese language, where both are considered in the same way.

3.4.3 *Fraction Names*

The order of writing (and reading) a fraction in Western languages is ‘first numerator, then denominator’, and the denominator is usually named with ordinal (not cardinal) numbers, such as ‘two thirds’ ($2/3$) of three parts. (In Chinese naming, taking two parts indicates a part-whole relationship rather than ‘two thirds’.) This method of fraction naming generates some difficulties for learning the part-whole relationship. The names for fractions in Western languages are not so clear. Bartolini Bussi et al. (2014) and Pimm and Sinclair (2015) analyse this difficulty and make proposals for overcoming it.

3.4.4 *Arithmetic Operations*

Research studies have identified several difficulties that Western students have with algorithms. For instance, Fuson and Li (2009) point out that many students in the USA make the error of subtracting the smaller number in a column from the larger number even if the smaller number is on the top:

$$\begin{array}{r} 346 \\ -157 \\ \hline 211 \end{array}$$

This error may be reinforced by language confusion, as the names ‘minuend’ and ‘subtrahend’ do not emphasise the passive relationship between them (see above). However, this seems to be only a part of the story. Written algorithms for addition and subtraction were introduced in Europe by Leonardo Fibonacci in the thirteenth century. They hint at the actions performed on some kind of abacus (the Chinese *suàn pán*, the Japanese *soroban*, the Roman abacus or similar; see Menninger 1969). More recently, the spike abacus was introduced for teaching (see the figures in Chap. 9). In English and other Western languages, the operations in Figs. 3.7 and 3.8 are described using terms like ‘carrying’⁶ and ‘borrowing’.⁷ The same was not true when algorithms were introduced in ancient textbooks. In *Liber abaci*, the term ‘borrow’ is not used. Rather, a kind of compensation or invariance is suggested: to increase by 10 the units in the minuend and to increase by 10 the units of the subtrahend. In this process, the 10 to be added to the subtrahend must be ‘kept in hands’ (*reservare in manibus*, in Latin). This strategy was maintained in many method textbooks for primary schoolteachers in Italy until at least 1930.

⁶ *Riporto* - *riportare* in Italian; *Übertrag* in German; *llevar* in Spanish; *retenue* in French.

⁷ *Prestito* in Italian, *anleihe* in German, *prestar* in Spanish; *retenue* in French.

Ross and Pratt-Cotter (2000, 2008) reconstruct the story of the word ‘borrowing’ in North America. They find the first occurrence in a textbook by Osborne in 1827, but observe that ‘the term borrow may be a misnomer since it suggests that something needs to be returned’ (p. 49). Fuson and Li (2009) criticise this word (which was used for more than one century), and Fuson uses the words ‘grouping’ (for addition), ‘ungrouping’ (for subtraction) and ‘regrouping’ (if necessary in both cases) in the Math Expression project.⁸

The situation is quite different in China. In teaching subtraction with regrouping, the majority of the Chinese teachers interviewed in Ma (1999) describe the so-called ‘borrowing’ step in the algorithm as ‘a process of decomposing a unit of higher value instead of saying “you borrow 1 ten from the tens place”’ (p. 8). One third-grade teacher explained why she thought the expression ‘decomposing a unit of higher value’ was conceptually accurate:

The term ‘borrowing’ can’t explain why you can take 10 to the ones place. But ‘decomposing’ can. When you say decomposing it implies that the digits in higher places are actually composed of those at lower places. They are exchangeable. The term ‘borrowing’ does not mean the composing-decomposing process at all. (p. 9)

The English terms ‘carrying’ and ‘borrowing’ are not related to each other. The French term ‘retenue’ is the same for both operations. ‘*Retenue*’ literally means ‘keep in mind’ (or ‘keep in hand’ in French) and hence hints at memory and not a concrete action. The origin may be traced back to the term used in medieval arithmetic ‘*reservare in manibus*’ (‘to keep in hands’). The use of the same term for different actions creates many difficulties for pupils (Soury-Lavergne, personal communication). This simple example shows that different cultures/languages may foster or hinder the understanding of meaning.

3.4.5 *Mathematical Relational Thinking: Equality or Sameness*

3.4.5.1 **Some Reported Difficulties in the Understanding of Equality**

Several studies have been carried out to examine the use of the equality symbol ‘=’ in mathematics education. Kieran (1981) studies the interpretation of the equality symbol in the early grades. In preschool, two intuitive meanings appear: the first (*conceptual or relational meaning*) concerns the relation between two sets with the same cardinality (hence an equivalence relation, according to the historical genesis), while the second concerns the set resulting from the union of two sets. The second is related to the interpretation of ‘+’ and ‘=’ in terms of actions to be performed (*procedural or operational meaning*). This latter view is reinforced through the use

⁸<http://www.hmhc.com/shop/education-curriculum/math/elementary-mathematics/math-expressions>

of pocket calculators and the transcription of the additions and results as they appear on the display. For instance, to add the following numbers in a notebook:

$$15 + 31 + 18$$

it is common to see the following:

$$15 + 31 = 46 + 18 = 64$$

This discussion was carried out in a third-grade classroom in Italy. Only some excerpts are reported. The teacher (Rosa Santarelli) posed the following problem:

How many days for holidays last summer?

Two pupils have solved the problem as follows:

$$30 - 10 = 20 + 31 = 51 + 31 = 82 + 15 = 97$$

Do you think that this calculation is correct?

STE: Yes, it is correct. They have thought about the months of holidays. Hence, this month has so many days, and they have put that month. In June we were at school for 10 days, hence $30 - 10$ [T]hen they have written the equal sign and then 20 and from that 20 they have started to count all the holidays. They have written $+31$, then 51, $+ 31$ equals 82, $+ 15$ (the days in September) equals 97. Then they have understood the result, they have written it. What they have done is right.

Many pupils agree and reword the same process.

TEACHER: But what does the sign '=' mean in mathematics?

GIO: Equal means that if you have $20 + 30$ you put the equal sign and you get the result.

The equal sign tells the result of an operation ...

CAR: If you wish to use this sign in an operation, you must put it at the end. If you make $5 + 5 =$ then you write 10.

Other pupils reword the same statements.

TEACHER: What does it mean 'to be equal to' in mathematics?

ILA: It means that you get the result.

SAM: Equal, in mathematics, is usually in the operations. It is used to get the result.

...

TEACHER: Is it correct to write ' $8 = 8$ '?

GIO: No, it isn't. You must write ' $+0$ ' or else one doesn't understand. You need to put something.

TEACHER: Hence, I make a mistake if I write ' $8 = 8$ '.

GIO: Yes, you do. You should write ' $8 + 0 = 8$ ' or ' $8 - 0 = 8$ '. (Zan 2007, p. 79 ff., our translation)

This short excerpt confirms that the procedural meaning of the equality symbol is often dominant in primary schools, at the expense of the relational meaning. Ni (2015) argues that student errors such as considering the equal sign as an order to 'do something' for an answer probably contribute to the difficulty they experience later when learning algebra; students treat an algebraic equation as indicating not a mathematical relation, but an order to 'do something' to obtain an answer. This may have very bad consequences in secondary school, when algebraic expressions are in the foreground. It is not possible to interpret the following equation according to the conceptual meaning:

$$x + 3 = 4$$

Teachers tacitly reinforce the procedural meaning when they do not take care of this issue.

3.4.5.2 Variation Problems in China and Italy

Bartolini Bussi et al. (2013) report an example of variation problems from the OPMC category, where all of the problems are collected in one 3×3 table (see also Sullivan et al. 2015, p. 88). In China, a collection of variation problems was given to second graders at the end of the school year as a kind of summary, with several different examples of problems presented during the school year. It was expected that the task would be solved in just one lesson due to the background knowledge of the students. Bartolini Bussi et al. used this task in some Italian schools, but a process of *cultural transposition* was needed (see Chap. 13 of this volume) (Table 3.3).

The most evident effect of this transposition was the time needed. It was not possible to solve the task in just one lesson. The task was the source of a longer process, where the students had to become familiar with this surprising way of considering several problems together and using schemes to find/represent the solution. During the process, the students started to focus on the relationships between operations rather than on the execution of operations and hence started reasoning algebraically. Some further experiments (Mellone and Ramploud 2015) are in progress now.

3.5 Concluding Remarks

The attention to differences in whole number approaches is increasing. It is worthwhile to mention at least the book by Owens (2015), with a chapter on visuospatial reasoning with numbers, and the book by Owens et al. (2017) on the history of number in Papua New Guinea and Oceania that details number systems other than base 10 systems.

The examples discussed in this chapter show that language plays a common, key role in conveying concepts in the teaching and learning of whole number arithmetic. A cross-cultural examination of languages should thus allow us to understand linguistic supports and limitations that may foster or hinder students' learning and teachers' teaching of mathematics.

The above discussion highlights that in many cases the Chinese way to develop whole number arithmetic seems to offer advantages for the construction of mathematical meanings: the attention to mathematical consistency and coherence seems larger than in the Western curricula. Yet the Chinese case shows that the difference is strongly related to linguistic and cultural features not shared by other cultural groups. This observation suggests that caution must be taken when trying to apply some of the Chinese methods in other countries, unless a careful process of cultural transposition is established.

Table 3.3 An example of variation problems from the OPMC category Beijing Education Science Research Institute and Beijing Instruction Research Center for Basic Education (1996), vol. 4, p. 88

Solve the following nine problems and then explain why they have been arranged in rows and columns in this way, commenting on their relationships.

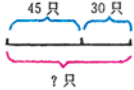
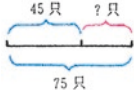
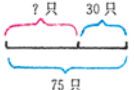
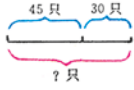
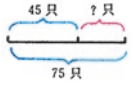
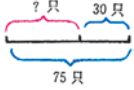
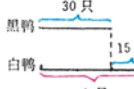
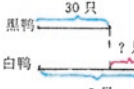
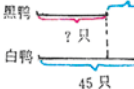
<p>(1) <i>In the river there are 45 white ducks and 30 black ducks. How many ducks are there altogether?</i></p>	<p>(2) <i>In the river there are white ducks and black ducks. There are 75 ducks altogether. 45 are white ducks. How many black ducks are there?</i></p>	<p>(3) <i>In the river there are white ducks and black ducks. There are 75 ducks altogether. 30 are black ducks. How many white ducks are there?</i></p>
		
<p>(1) <i>In the river there is a group of ducks. 30 ducks swim away. 45 ducks are still there. How many ducks were in the group to begin with?</i></p>	<p>(2) <i>In the river there are 75 ducks. Some ducks swim away. There are still 45 ducks. How many ducks swam away?</i></p>	<p>(3) <i>In the river there are 75 ducks. 30 ducks swim away. How many ducks are still there?</i></p>
		
<p>(1) <i>In the river there are 30 black ducks. There are 15 more white ducks than black ducks (15 fewer black ducks than white ducks). How many white ducks are there?</i></p>	<p>(2) <i>In the river there are 30 black ducks and 45 white ducks. How many more white ducks than black ducks (how many fewer black ducks than white ducks) are there?</i></p>	<p>(3) <i>In the river there are 45 white ducks. There are 15 fewer black ducks than white ducks (15 more white ducks than black ducks). How many black ducks are there?</i></p>
		

Acknowledgements These language and cultural issues were debated in different working groups, mainly working groups 1 (Chap. 5) and 3 (Chap. 9). We considered it important to collect contributions in a more systematic way in this chapter. We wish to thank all of the participants in the two working groups for providing interesting discussions and examples.

References

- Allan, K. (1977). Classifiers. *Language*, 53(2), 285–311.
- Askew, M. (2013). Big ideas in primary mathematics: Issues and directions. *Perspectives in Education*, 31(3), 5–18.
- Bakker, M., van den Heuvel-Panhuizen, M., & Robitzsch, A. (2014). First-graders' knowledge of multiplicative reasoning before formal instruction in this domain. *Contemporary Educational Psychology*, 39, 59–73.

- Bartolini Bussi, M. G. (2011). Artifacts and utilization schemes in mathematics teacher education: Place value in early childhood education. *Journal of Mathematics Teacher Education*, 14(2), 93–112.
- Bartolini Bussi M. G., Sun X., & Ramploud A. (2013). A dialogue between cultures about task design for primary school. In C. Margolinas (Ed.), *Task design in mathematics education: Proceedings of ICMI study 22* (pp. 549–558). Retrieved 20 Jan 2016 from <https://hal.archives-ouvertes.fr/hal-00834054>
- Bartolini Bussi, M. G., Baccaglini-Frank, A., & Ramploud, A. (2014). Intercultural dialogue and the history and geography of thought. *For the Learning of Mathematics*, 34(1), 31–33.
- Barwell, R., Clarkson, P., Halai, A., Kazima, M., Moschkovich, J., Planas, N., Phakeng, M., Valero, P., & Villavicencio Ubillús, M. (Eds.). (2016). *Mathematics education and language diversity: The 21st ICMI study*. New York: Springer.
- Bazzanella, C. (2011). Indeterminacy in dialogue. *Language and Dialogue*, 1(1), 21–43.
- Butterworth, B. (1999). *The mathematical brain*. London: Macmillan.
- Cai, J. (1998). An investigation of U.S. and Chinese students' mathematical problem posing and problem solving. *Mathematics Education Research Journal*, 10(1), 37–50.
- Cai, J., & Knuth, E. (2011). *Early algebraization: A global dialogue from multiple perspectives*. Heidelberg: Springer.
- Cai, J., & Nie, B. (2007). Problem solving in Chinese mathematics education: Research and practice. *ZDM Mathematics Education*, 39(5–6), 459–473.
- Cajori, F. (1928). *A history of mathematical notations*. London: The Open Court Company.
- Chauma, A. (2012). Teaching primary mathematical concepts in Chitumbuka: A quest for teacher education. *South African Journal of Higher Education*, 26(6), 1280–1295.
- Chemla, K. (1996). Positions et changements en mathématiques à partir de textes chinois des dynasties Han à Song-Yuan. Quelques remarques. In *Extrême-Orient, Extrême-Occident*, n° 18. Disposer pour dire, placer pour penser, situer pour agir: Pratiques de la position en Chine (pp. 115–147).
- Chemla K. (1998). History of mathematics in China: A factor in world history and a source for new questions. *Doc. Math. J. DMV extra volume ICM III (1998)*, 789–798.
- Cullen, C. (1996). *Astronomy and mathematics in ancient China: The zhou bi suan jing*. Cambridge: Cambridge University Press.
- Dauben, J. (2002). Book review: The universal history of numbers and the universal history of computing (part 1). *Notices of the AMS*, 49(1), 32–38.
- Fan, L., Wong, N. Y., Cai, J., & Li, S. (Eds.). (2004). *How Chinese learn mathematics: Perspectives from insiders*. Singapore: World Scientific.
- Fan, L., Wong, N. Y., Cai, J., & Li, S. (2015). *How Chinese teach mathematics: Perspectives from insiders*. Singapore: World Scientific.
- Funghi, S. (2016). Tables of numerals and others mathematical terms in different languages. Free download from <http://www.umac.mo/fed/ICMI23/doc/tabels%20of%20numerals%20in%20different%20languages.pdf>.
- Fuson, K. C., & Briars, D. (1990). Using a base-ten blocks learning/teaching approach for first and second-grade place value and multidigit addition and subtraction. *Journal for Research in Mathematics Education*, 21(3), 180–206.
- Fuson, K. C., & Kwon, Y. (1992). Korean children's understanding of multidigit addition and subtraction. *Child Development*, 63(2), 491–506.
- Fuson, K. C., & Li, Y. (2009). Cross-cultural issues in linguistic, visual-quantitative, and written-numeric supports for mathematical thinking. *ZDM Mathematics Education*, 41(6), 793–808.
- Galligan, L. (2001). Possible effects of English-Chinese language differences on the processing of mathematical text: A review. *Mathematics Education Research Journal*, 13(2), 112–132.

- Geary, D. C., Bow-Thomas, C. C., Fan, L., & Siegler, R. S. (1993). Even before formal instruction, Chinese children outperform American children in mental addition. *Cognitive Development*, 8(4), 517–529.
- Geary, D. C., Fan, L., & Bow-Thomas, C. C. (1992). Numerical cognition: Loci of ability differences comparing children from China and the United States. *Psychological Science*, 3(3), 180–185.
- Guo, S. (2010). *Chinese history of science and technology*. Beijing: Science Press. [In Chinese].
- Halai, A., & Karuka, S. (2013). Implementing language-in-education policy in multilingual mathematics classrooms: Pedagogical implications. *Eurasia Journal of Mathematics, Science & Technology Education*, 9(1), 23–32.
- Ho, C. S. H., & Fuson, K. C. (1998). Children's knowledge of teen quantities as tens and ones: Comparisons of Chinese, British, and American kindergartners. *Journal of Educational Psychology*, 90(3), 536.
- Howe, R. (2010). *Three pillars of first grade mathematics*. On the web at e.g: <http://commoncore-tools.me/2012/02/08/article-by-roger-howe-three-pillars-of-firstgrade-mathematics/>
- Howe, R. (2011). *The greatest calamity in the history of science*. Editorial, ICMI Newsletter 18.
- Ifrah, G. (1981). *Histoire Universelle des Chiffres*. Paris: Editions Seghers/CNRS.
- Kamii, C. (1986). Place value: An explanation of its difficulty and educational implications for the primary grades. *Journal of Research in Childhood Education*, 1(2), 75–86.
- Kieran, C. (1981). Concepts associated with the equality symbol. *Educational Studies in Mathematics*, 12(3), 317–326.
- Krifka, M. (2007). Approximate interpretation of number words: A case for strategic communication. In G. Bouma, I. Krämer, & J. Zwarts (Eds.), *Cognitive foundations of interpretation* (pp. 111–126). Amsterdam: Koninklijke Nederlandse Akademie van Wetenschappen.
- Kwa, T. M. (1922). *The fundamental operations in bead arithmetic. How to use the Chinese abacus, Manila 1922*. Retrieved April 25, 2016, from http://www.google.it/url?sa=t&rct=j&q=&src=s&source=web&cd=1&ved=0ahUKEwj_pODQ2qnMAhXGWxoKHc2NDgUQFggdMAA&url=http%3A%2F%2Fpyramidal-foundational-information.com%2Ffile_download%2F415%2FChinese%2Babacus.pdf&usq=AFQjCNFC58zR0pYviS9QL9jU67WY0VO5mQ&sig2=ptok1mRe6gfMfug5bSmkBw
- Lam, L. Y., & Ang, T. S. (1992/2004). *Fleeting footsteps: Tracing the conception of arithmetic and algebra in ancient China* (Revised edition). Singapore: World Scientific.
- Lavric, E. (2010). Hyperbolic approximative numerals in cross-cultural comparison. In G. Kaltenböck, W. Mihatsch, & S. Schneider (Eds.), *New approaches to hedging* (pp. 123–164). Bingley: Emerald.
- Leung F. K., Graf K. D., & Lopez-Real F. J. (Eds.) (2006). *Mathematics education in different cultural traditions – A comparative study of East Asia and the West: The 13th ICMI study*. New York: Springer.
- Levin, S. R. (1982). Aristotle's theory of metaphor. *Philosophy & Rhetoric*, 15(1), 24–46.
- Li, Y., & Huang, R. (Eds.). (2013). *How Chinese teach mathematics and improve teaching*. New York: Routledge.
- Li, X., Ding, M., Capraro, M. M., & Capraro, R. M. (2008). Sources of differences in children's understandings of mathematical equality: Comparative analysis of teacher guides and student texts in China and the United States. *Cognition and Instruction*, 26(2), 195–217.
- Ma, L. (1999). *Knowing and teaching elementary mathematics: Teachers' understanding of fundamental mathematics in China and the United States*. Mahwah: Lawrence Erlbaum Associates.
- Marton, F., Tse, S. K., & Cheung, W. M. (2010). *On the learning of Chinese*. Rotterdam: Sense Publishers.
- Martzloff, J. C. (1997). *A history of Chinese mathematics*. Berlin/Heidelberg: Springer Verlag.

- Mathematics Textbook Developer Group for Elementary School. (2005). *Mathematics*. Beijing: People's Education Press. [In Chinese].
- Menninger, K. (1969). *Number words and number symbols: A cultural history of numbers*. Cambridge, MA: The MIT Press. (Translated from the German edition of 1958).
- Miller, K. F., Major, S. M., & Shu, H. (2000). Ordinal knowledge: Number names and number concepts in Chinese and English. *Canadian Journal of Experimental Psychology*, 54(2), 129–139.
- Ministry of Education and Vocational Training. (2014). *Education and Training Policy*. (in Swahili). Retrieved from http://www.moe.go.tz/index.php?option=com_docman&Itemid=617.
- Murata, A. (2004). Paths to learning ten-structured understanding of teen sums: Addition solution methods of Japanese grade 1 students. *Cognition and Instruction*, 22(2), 185–218.
- Murata, A., & Fuson, K. (2001). Learning paths to 5- and 10-structured understanding of quantity: Addition and subtraction solution strategies of Japanese children. In R. Speiser, C. S. Maher, & C. Walter (Eds.), *Proceedings of the Twenty-third annual meeting of the North American Chapter of the International Group for the Psychology of Mathematics Education: Vol. 2* (pp. 639–646). Columbus: ERIC Clearinghouse for Science and Environmental Education: Mathematics.
- Murata, A., & Fuson, K. (2006). Teaching as assisting individual constructive paths within an interdependent class learning zone: Japanese first graders learning to add using 10. *Journal for Research in Mathematics Education*, 37(5), 421–456.
- National Curriculum Development Centre. (n.d.). *The national primary school curriculum for Uganda: Teachers' guide primary 1*. Kampala: The Author.
- Needham, J., & Wang, L. (1959). *Mathematics and the sciences of the heavens and earth. The science and civilization in China series* (Vol. III). Cambridge: Cambridge Press.
- Ng, S. S. N., & Rao, N. (2010). Chinese number words, culture, and mathematics learning. *Review of Educational Research*, 80(2), 180–206.
- Owens, K. (2015). *Visuospatial reasoning: An ecocultural perspective for space, geometry and measurement education*. New York: Springer.
- Owens, K., & Lean, G. with Paraide, P., & Muke, C. (2017). *History of number: Evidence from Papua New Guinea and Oceania*. New York: Springer.
- Ran, Y. (2010). Approximative expressions and their loose uses in Chinese. In G. Kaltent,ck, W. Mihatsch & S. Schneider (Eds.), *New approaches to hedging* (pp. 165–180). Bingley: Emerald.
- Ross, S. H. (1989). Parts, wholes, and place value: A developmental view. *The Arithmetic Teacher*, 36(6), 47–51.
- Ross, S., & Pratt-Cotter, M. (2000). Subtraction in the United States: An historical perspective. *The Mathematics Educator*, 8(1), 49–56.
- Schwartzman, S. (1994). *The words of mathematics: An etymological dictionary of mathematical terms used in English*. Washington, DC: Mathematical Association of America.
- Senft, G. (Ed.). (2000). *Systems of nominal classification*. Cambridge: Cambridge University Press.
- Sepeng, P. (2014). Learners' voices on the issues of language use in learning mathematics. *International Journal of Educational Sciences*, 6(2), 207–215.
- Siu, M. K. (2004). Official curriculum in mathematics in ancient China: How did candidates study for the examination? In L. Fan, N. Y. Wong, J. Cai, & S. Li (Eds.), *How Chinese learn mathematics: Perspectives from insiders* (pp. 157–185). Singapore: World Scientific.
- Sun, X. (2007). *Spiral variation (Bianshi) curricula design in mathematics: Theory and practice*. Unpublished doctoral dissertation, Hong Kong: The Chinese University of Hong Kong [in Chinese].
- Sun, X. (2011). Variation problems and their roles in the topic of fraction division in Chinese mathematics textbook examples. *Educational Studies in Mathematics*, 76(1), 65–85.

- Sun, X. (2013). *The fundamental idea of mathematical tasks design in China: The origin and development*, paper presented in ICMI STUDY 22: Task design in mathematics education, University of Oxford, 22/07/2013–26/07/2013.
- Sun, X. (2016). *Spiral variation: A hidden theory to interpret the logic to design Chinese mathematics curriculum and instruction in mainland China*. Singapore: World Scientific [in Chinese].
- Sun, X. & Sun, Y. (2012). *The systematic model LÜ (率) of Jiu Zhang Suan Shu and its educational implication in fractional computation*, Paper presented at the 12th International Congress on Mathematics Education Seoul, Korea 08/07/2012–15/07/2012.
- Sullivan, P., Knott, L., & Yang, Y. (2015). The relationships between task design, anticipated pedagogies, and student learning. In A. Watson & M. Ohtani (Eds.), *Task design: The 22nd ICMI study* (pp. 88–114). Cham: Springer.
- Tempier, F. (2013). *La numération décimale de position à l'école primaire: Une ingénierie didactique pour le développement d'une ressource*. Thèse. Univ. Paris 7.
- Verran, H. (2001). *Science and African logic*. Chicago: University of Chicago Press.
- Volkov, A. (1996). Review of *Fleeting Footsteps*. *Archives Internationales d'Histoire des Sciences*, 46(136), 155–159.
- Wang, J. (2013). *Mathematics education in China: Tradition and reality*. Singapore: CENGAGE Learning.
- Wylie, A. (1853). Jottings on the sciences of the Chinese. *North Chinese Herald*, Shanghai.
- Xie, X., & Carspecken, P. F. (2007). *Philosophy, learning and the mathematics curriculum: Dialectical materialism and pragmatism related to Chinese and American mathematics curriculums*. Rotterdam: Sense Publishers.
- Zan, R. (2007). *Difficoltà in matematica: Osservare, interpretare, intervenire*. Milano: Springer.
- Zaslavsky, C. (1973). *Africa counts: Number and pattern in African cultures*. Boston, MA: Prindle, Weber & Schmidt.

Cited Papers from Sun, X., Kaur, B., & Novotna, J. (Eds.). (2015). Conference proceedings of the ICMI study 23: Primary mathematics study on whole numbers. Retrieved February 10, 2016, from www.umac.mo/fed/ICMI23/doc/Proceedings_ICMI_STUDY_23_final.pdf

- Alafaleq, M., Mailizar, L., Wang, Y., & Fan, L. (2015). How equality and inequality of whole numbers are introduced in China, Indonesia and Saudi Arabia primary mathematics textbooks (pp. 392–398).
- Azrou, N. (2015). Spoken and written arithmetic in post-colonial countries: The case of Algeria (pp. 44–51).
- Bass, H. (2015). Quantities, numbers, number name, and number line (pp. 10–20).
- Ejersbo, L. R., & Misfeldt, M. (2015). The relationship between number names and number concepts (pp. 84–91).
- Houdement, C., & Tempier, F. (2015). Teaching numeration units: Why, how and limits (pp. 99–106).
- Howe, R. (2015). The most important thing for your child to learn about arithmetic (pp. 107–114).
- Ma, L. (2015). The theoretical core of whole number arithmetic (pp. 34–38).
- Mellone, M., & Ramploud, A. (2015). Additive structure: An educational experience of cultural transposition (pp. 567–574).

- Ni, Y. (2015). How the Chinese methods produce arithmetic proficiency in children (pp. 339–345).
- Pimm, D., & Sinclair, N. (2015). The ordinal and the fractional: Some remarks on a trans-linguistic study (pp. 354–361).
- Sun, X. (2015). Chinese core tradition to whole number arithmetic (pp. 140–148).
- Young-Loveridge, J., & Bicknell, B. (2015). Using multiplication and division contexts to build place-value understanding (pp. 379–386).
- Zou, D. (2015). Whole number in ancient Chinese civilisation: A survey based on the system of counting-units and the expressions (pp. 157–164).

Open Access This chapter is licensed under the terms of the Creative Commons Attribution 4.0 International License (<http://creativecommons.org/licenses/by/4.0/>), which permits use, sharing, adaptation, distribution and reproduction in any medium or format, as long as you give appropriate credit to the original author(s) and the source, provide a link to the Creative Commons license and indicate if changes were made.

The images or other third party material in this chapter are included in the chapter's Creative Commons license, unless indicated otherwise in a credit line to the material. If material is not included in the chapter's Creative Commons license and your intended use is not permitted by statutory regulation or exceeds the permitted use, you will need to obtain permission directly from the copyright holder.



Chapter 4

On Number Language: A Commentary on Chapter 3



David Pimm 

4.1 Introduction

I start with a policy statement, pretty unrelated to the previous chapter. I am always a little taken aback to see numbers or other mathematical symbols (e.g. ‘7’ rather than ‘seven’, ‘+’ rather than ‘plus’) presented inside classroom transcripts, which supposedly provide a written account of what was *said*. Everything that is said is said by someone in some natural language (or natural language mix – cf. code-switching, e.g. Setati 1998 – such as where a somewhat bilingual speaker may know how to say the higher number words in one language only). Non-verbal numerals (of whatever sort) are *not* part of any natural language,¹ so they require ways to be read aloud *into* such a language. Because of this, I believe it is important to be very, very precise about marking such distinctions. In Pimm (1987), for instance, I distinguished between what I termed a ‘spelling’ reading and an ‘interpretative’ reading of written mathematics: for example, is the Biblical ‘number of the beast’ (666) to be said as ‘six six six’ or is it ‘six hundred and sixty-six’ (in British English) or ‘six hundred sixty-six’ (in the North American version)? What it is not, however, is ‘six hundreds (and) sixty-six’, something I will come back to later on.²

¹Chrisomalis asserts, ‘Over 100 structurally different numerical notation systems are known to have been used between 3500 BCE and the present day [...] Unlike number words, they represent numbers translanguistically, and do not follow the language or lexicon of any specific language. Unlike tallies, they represent completed enumerations, and unlike computational technologies, they create permanent records of numerals’ (Chrisomalis 2009, pp. 506–7).

²Note this is not true when saying decimals in English: ‘666.66’ can be read aloud as six hundred (and) sixty-six and sixty-six hundredths. The negative whole number powers of ten are always read in terms of plural-marked units.

D. Pimm (✉)
Simon Fraser University, Burnaby, BC, Canada
e-mail: djp3@sfu.ca

Is ‘six six six’ even a spoken number or simply a time-ordered string of digits being listed in turn (one no different from a reading into English of ‘6, 6, 6’ rather than ‘666’), one that ignores the positional structure? In French, certain numbers (such as phone numbers) whose cardinal value is seldom of interest are frequently read (and written) as sequences of two-digit numbers: 02 65 47 23 46. I will come back to this later too when querying whether the number-word system of any language reflects place value (or better put perhaps, in relation to speech, ‘temporal value’). My broader point is that there are significant differences between speaking and writing in relation to numbers, most particularly when it comes to engaging with the written symbolism of mathematics (not least of number), differences that are forgotten at our peril.

As numerical anthropologist Stephen Chrisomalis claims, ‘The linkages between number words, computational technologies, and number symbols are complex, and understanding the functions each serves (and does not serve) will help illustrate the range of variability among the cognitive and social systems underlying all mathematics’ (Chrisomalis 2009, p. 496).

4.2 What Is Written and What Is Said

I start by echoing the claim from early on in Chap. 3 that ‘whole number arithmetic is not culture-free, but deeply rooted in local languages and cultures with the inherent difficulty of transposition and culture perspective’ (this volume, Sect. 3.1.2). As mathematician René Thom once observed:

when learning to speak, a baby babbles in all the phonemes of all the languages of all the world, but after listening to its mother’s replies soon learns to babble in only the phonemes of its mother’s language. (cited in Ziman 1978, p. 18)

Also, from Chap. 3’s opening page, the expression ‘cultures of speaking’ brought to mind the fact that there are ‘cultures of writing’ too (e.g. the order of writing of the two numerals within a single fraction – see Bartolini Bussi et al. 2014) and that these two may not perfectly align within a single ‘culture’ (see later for a further example involving grouping of digits within a large number in relation to how they are read). And these both influence and are influenced by the physical actions and gestures implicated in counting and computation (a fact worthy of the historical and geographical term ‘cultures of gesture’, such as varied forms of finger counting and finger calculation³ – for many examples and a classification scheme, see Bender and Beller 2012). It is important to remember that, in many times and places, these two mathematical actions (counting and computation) were barely connected at all –

³One instance is recorded in the writings of the Northumbrian monk Bede (674–723 CE): for example, in *De temporum ratione*. O’Daly (2014) writes: ‘The hand, the most portable device of all, was a powerful tool for symbolic representation, calculation, and mental processing in the Middle Ages, and indicates the presence of a comprehensive, but elusive, gestural vocabulary, the full meaning of which we can only guess’.

e.g. the combined but unrelated use of Roman numerals to hold numbers and counting boards with which to calculate (see Tahta 1991; Chrisomalis 2010).

In response to the piece about fraction writing order by Bartolini Bussi et al. (2014), I wrote:

With fractions written by hand, the composite symbol is produced in a given, temporal order. How might that gestural order relate either to what is said or to how what is said is conventionally written? In English, the first word spoken in time is the numerator: is this so for any language? When a fraction word is written down in English, left to right, the numerator is again the first word to be written. (Ditto the question about other languages.) But when the composite symbol for the fraction is produced, there are variations possible, as their terrific vignettes from China and Burma attest. But both examples point to the arbitrary nature of manual symbol formation (in Hewitt's 1999 use of that word) and to the fact that, once made, the symbol retains (almost) no trace of its making [not least its order]. (Pimm 2014, p. 15)

The many cultures of number are fascinating and intricate, and the particularities of language vis-à-vis time and place, in interaction with computational technological devices (which have existed for at least 5000 years), offer a most worthwhile focus for profound attention. In relation to very recent work concerned with what might be termed 'tangible technological gestures' (see Sinclair and de Freitas 2014, not least in regard to Jackiw and Sinclair 2014), languages themselves at times encode forms of gesturing that have their own transparencies and opacities, their own generalities and idiosyncrasies, all of which form part of the complex symbolic world into which all children are born.

For Wittgenstein, language is, initially but fundamentally, reactive, the word not being the origin:

The origin and the primitive form of the language game is a reaction; only from this can more complicated forms develop. Language – I want to say – is a refinement, 'im Anfang war die Tat' [in the beginning was the deed]. (Wittgenstein 1937/1976, p. 420)⁴

In relation to the deed of counting, the specific pedagogic language of computational practice (e.g. the English arithmetic metaphor in addition of 'borrowing' and 'paying back') brings with it the possibility that it was at one point literal. One potential example taken from Chap. 3 relates to the suggested link between the medieval Latin expression *reservare in manibus* ('to keep in the hands') and the more contemporary French term à *retenir* ('to keep in mind'). It crossed my mind that the former, in relation to abaci and counting boards, might literally refer to what the hands had to do. Elsewhere, Wittgenstein also commented, 'Remember the impression one gets from good architecture, that it expresses a thought. It makes one want to respond with a gesture' (Wittgenstein 1932, p. 22e). This observation reminded me of the Egyptian hieroglyph for million (𓆎), plausibly a human whole-body gesture at the large size of the number.

Language is not separable from culture nor from gesture (especially not in the context of counting). Gestures perhaps have evolved over a longer period and

⁴For much more on this, see Zwicky (1992).

perhaps have left their trace on the language.⁵ There is also the possibility of temporal slippage of one system in relation to a development within the other, not dissimilar to those identified by Lakoff and Núñez (2000) with regard to the calculus, whereby the (static) talk is mid-nineteenth century, while associated (dynamic) gestures are more seventeenth century in nature (more fitting to the notion and language of a moving variable, a language that is returning with dynamic geometry environments).

In particular, Raphael Núñez examined the co-production of gestures and speech of Guershon Harel proving a result from real analysis. Núñez observes:

The study of gesture production and its temporal dynamics is particularly interesting because it reveals aspects of thinking and meaning that are effortless, extremely fast, and lying beyond conscious awareness (therefore not available for introspection). (2009, p. 319)

But it is also true that the gestures are co-produced when counting (and that in certain circumstances *constitute* counting), phenomena that are equally worthy of study as their higher mathematical counterparts. Nevertheless, the focus of this chapter as well as its predecessor is on number language and not number gestures, even though I do not wish to dismiss the latter as epiphenomenal, the way labelling them ‘paralinguistic’ does.

4.3 On Place Value

With regard to place value, one of Chap. 3’s central themes, I have three main observations to make.

First, I would like to consider whether the phenomenon of place value exists solely in relation to written numerals (i.e. written marks, nowadays usually, but not always, employing what are termed Hindu-Arabic numerals⁶) and not in respect of written words or characters from a natural language and whether it also could describe aspects of spoken number words in a natural language as well (or even gestural language – query: *what is the structure of number signs in British, American or Chinese sign language?*). This question reflects my increasing uncertainty as to what place value actually is, as well as echoing Tahta’s (1991) informed assertion that place value is appreciably overemphasised in Western mathematics teaching –

⁵Numeration systems are among the most linguistically stable systems that exist: the pronunciation split within proto-Indo-European languages into classes labelled *centum* and *satem* (two different words for ‘hundred’, in Latin and Avestan, respectively) is a surface reflection of this. For an intriguing account of zero, see Rotman (1987).

⁶Chrisomalis (2009) helpfully observes, “I use the term ‘western’ to refer to the signs 0123456789 instead of ‘Arabic’ and ‘Hindu-Arabic’, not to deny that this innovation was borrowed from a Hindu antecedent through an Arabic intermediary, but to avoid confusion with the distinct Indian and Arabic numerical notations used widely to this day. Rendering these latter notations ‘invisible’ through nomenclature is counterproductive and potentially ethnocentric.” (p. 496). In response to this, hereafter I use single quotation marks around ‘Hindu-Arabic’ in this chapter.

and the discussion of Chinese numeration in Chap. 3 relates to this, when the authors claim, ‘The transparency of Chinese [number] names is likely to foster students’ understanding for place value’ (this volume, Sect. 3.2.2). Though if, as I argue below, place value is simply a convention, then there is a strong question as to whether it is something that is amenable to being ‘understood’, rather than simply complied with (see Hewitt 1999).

My questioning arose from reading Chap. 3. The authors claim that traces (which they nicely term ‘memories’) exist within many spoken numeration systems within natural languages. But these are, at best, ordinal traces, with regard to how number names are said in a conventional order (in English, in decreasing powers of ten, although exceptions like four-and-twenty still exist; in German, the decades are systematically said *after* the units, e.g. 54 is *vier-und-fünfzig*, ‘four-and-fifty’). This raised two sub-questions: *does it make sense even to ask whether written (or spoken) natural language numeration systems are or are not place value* and, in regard to written numeration systems that were not place value (e.g. the ancient Egyptian one), *what were their spoken counting systems like?*

In regard to the first question, my (admittedly strong, potentially over-strong) conjecture is no *spoken* language-based numeration system **is** place value (not even Asian ones, which would be the most likely contenders). This is because the structure of how number words are formed ensures that their decimal value is encoded as part of the string, thus changing either the written order (of language-specific symbols on the page) or (temporally) the spoken order in which the various parts of the numeral are said aloud does not alter the combined total. It may go against convention (as ‘four-and-twenty’ does), but it does not produce a different number. (Of course it is true that simply interchanging the ‘six’ and the ‘seven’ in ‘sixty-seven’ and ‘seventy-six’ changes the value but that ignores the fact that ‘six’ is part of ‘sixty’.) So possibly place value is solely a phenomenon of written, non-language-based numeration systems, and whichever natural language is used cannot help with this.

My second place value observation, which relates to the first, has particular force because of the particularities and peculiarities of manipulatives such as Dienes blocks (also known as multibase arithmetic blocks – see this volume, Sect. 9.3.1.2), which are regularly promulgated as a means to assist with acquiring the concept of place value. See Fig. 4.1.

It is a commonplace pedagogic move in English-language primary schools to use large sheets of paper and columns labelled (from left to right), thousands (or Th), hundreds (or H), tens (or T) and units (or U).⁷ The blocks are collected and placed in the respective columns and then ‘Hindu-Arabic’ digits are used to record the number of them in each column, hugely finessing the fact that it is actually the paper columns and not the blocks themselves that are both ‘holding’ the places and, consequently, carrying ‘place value’.

⁷And these too can go on, TThs for tens of thousands, HThs for hundreds of thousands, Ms for millions, etc. Note how both words for TThs and HThs are plural, but in the notation, only the latter is marked symbolically. For more on this, see Sect. 4.4 on ‘units’.

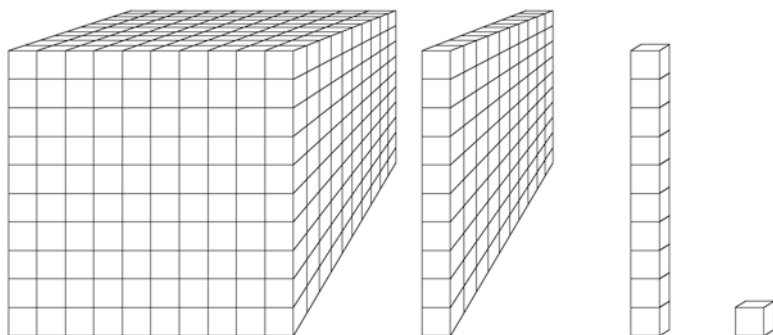

Fig. 4.1 Dienes blocks (1000, 100, 10 and 1)

However, as with the instance mentioned in Chap. 3 where a 7-year-old writes 10013 instead of 113, an accurate (as opposed to conventionally correct) notating from a corresponding Dienes block paper configuration would be $1H, 1T, 3U_s = 100, 10, 3 = 100103$. The question of quantity versus place is an intricate and arbitrary one (again in Hewitt's 1999 sense), and there is no *necessary* reason why there cannot be any number of blocks of any size in a single column (something an abacus masks by each spike having a set, uniform height relative to the diameter of the beads). Indeed, a higher (and linear-algebra-influenced) mathematical perspective has any whole number generated by the basis consisting of powers of 10 (and includes decimal fractions, if negative powers of 10 are permitted) with the coefficients 0–9. It is partly for this reason that I mentioned the six, six, six reading of '666' in the opening paragraphs of this commentary (as well as linking to David Fowler's 1987 historical reconstruction, via the arithmetic process of *anthyphaire-sis*, of a pre-Euclidean functioning definition of ratio).

Before raising further difficulties, there are three more observations I wish to make about Dienes blocks themselves. The first is that they can actually be modified to display any whole number or decimal fraction. To have ten thousand, for instance, one simply needs to stick together ten of the large cube size; for hundred thousand, a square array of a hundred of the large cube size; and for million, a cube array of a thousand the large cube size. For decimal fractions, merely rename one of the larger blocks (e.g. the larger cube or the 'long' or the 'flat' as they are sometime called) as 'one'.⁸ Secondly, this visuo-geometric repetition every 10^3 exactly fits the SI (*Système Internationale*) emphasis on grouping whole number digits into triples, as well as reflecting the standard metric naming structure of measures (though if we

⁸As is so often the way of these things, having figured this out for myself, I then came across the paper by Kim and Albert (2014) which purports both to give an account of and to account for the history of base-ten blocks. While disagreeing profoundly with much of their accounting for, they did remind me that in Dienes' (1963) book *An Experimental Study of Mathematics Learning* – a book which I read in 1972 as part of a very early mathematics education course taught by David Tall in the University of Warwick mathematics department – Dienes makes the same observation, on his p. 28.

wanted to use this to refer to a kilo-something, a milli-something or a micro-something, we would need a word for a standard counting unit – other than ‘unit’). My third observation is straightforward: there is a ‘natural’ and directly observable sense of decimal equivalence between each power of ten and the next one.

However, it strikes me that Dienes blocks are at least as good a fit to the base-ten system of Egyptian hieroglyphic numerals (which uses the repetition of vertical lines, hoops, scrolls, lotus flowers, etc. where there are no links whatsoever among the symbols for 1, 10, 100, 1000 and so on, either to record numbers or to calculate with them).⁹ (See Fig. 4.2.) And this numeration system is decidedly *not* a place value one.

In general, there are two alternate principles for generating words or other symbols for numbers: repetition (related to tallying) and cypherisation, namely, the use of distinct and independent symbols for each number. Many older symbolic systems use repetition as the primary principle. For example, below (see Fig. 4.3) depicts an example using the ancient Egyptian numeration system: on the left is the conventional order and on the right in a scrambled order. (Whole-number adding is totally unproblematic as the symbols themselves are simply combined, and any excess over nine of one power of ten is converted into one of the next power up.)

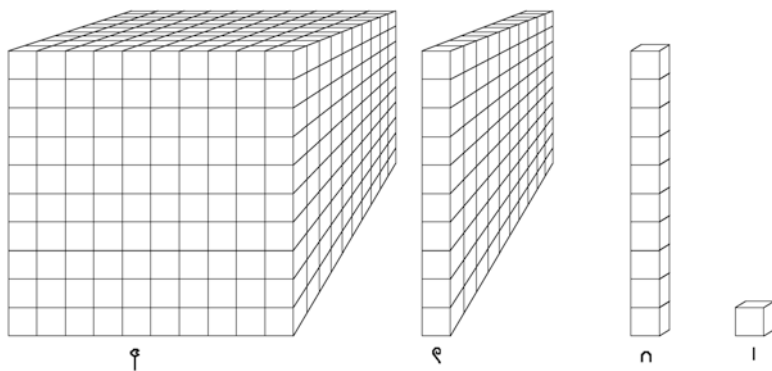

Fig. 4.2 A depiction of Dienes blocks (with ancient Egyptian hieroglyphs for 1000, 100, 10 and 1 appended)

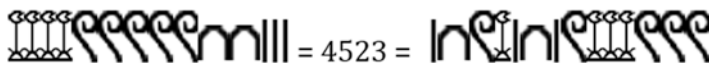

Fig. 4.3 An ancient Egyptian numeral (in conventional and scrambled order)

⁹This is not always the case historically. With Roman numerals, for instance, they are perfectly competent for recording numbers. However, due to a variety of principles being combined (both additive and subtractive, the use of 5, 50, 500, etc. as an intermediate resting place sometimes called a sub-base, etc.), they are not easily used for calculation (particularly multiplication and division). But the companion use of counting boards was perfectly adequate for that.

‘Full’ cypherisation means every initial numeral up to one less than the base has a different symbol (think 1, 2, 3, 4, 5, 6, 7, 8, 9). Chinese rod numerals (discussed in Chap. 3) reflect enormous flexibility with very limited cypherisation (the vertical rod and the horizontal rod), akin to Roman numerals I and V, only without the latter’s subtractive principle¹⁰ and much repetition, likely because they became traces of actual piles of rods used on counting boards, where an attribute of the board (lines, positions) took care of the place value. Likewise, ancient Babylonian numeration consists in its entirety of only two distinct stylus edge marks (one the same as the other only rotated through 90°), together with a mixed-base system (ten and sixty), repetition, a form of place value and contextual ‘floating point’.

One pragmatic test for any written system (presuming it makes repeated use of the same set of symbols or objects) with regard to its being place value or not is whether one can generically scramble the order of the marks and not affect the numerical value represented: this is true with Dienes blocks and also with ancient Egyptian numerals. In passing, it is also true of early Greek (Ionian) numerals (and are still used today for depicting ordinals), where the numeral for 1 bears no relation to that of 10 or 100, being different letters of the alphabet. The Egyptian numerals (as do the Greek) retain their specific decimal value, even when rearranged – see Pimm (1995) for more on these complexities of symbol/object manipulation. Consequently, Dienes blocks cannot ‘contain’ place value. So, if they do ‘work’, how do they ‘work’? The ‘value’ is there, but the ‘place’ is not.

Caleb Gattegno (e.g. Gattegno 1974) repeatedly proposed systematising language-based counting systems in elementary schools in different European languages, in order to make them easier to learn by being a far closer fit to the standard Western written numeration system. In particular, in English he wanted *ten* to be said as ‘one-ty’, *eleven* as ‘one-ty-one’ and *twelve* as ‘one-ty-two’¹¹ and then *twenty* as ‘two-ty’, *thirty* as ‘three-ty’ and so on. With the later decades (*sixty*, *seventy*, *eighty*, *ninety*), the changes merge with the actual empirical system. There is a *samizdat*-style community within Anglophone mathematics education (especially within the UK, but in North America and Western Europe too), which works extensively with Gattegno’s ideas (and the teaching aid of the Gattegno number chart, among others), in order to support the acquisition of structured fluency in number naming (for one recent instance, see Coles 2014).¹² The Chinese numeration system detailed in Chap. 3 (which presents in several other Asian languages too) has these properties already.

My third place value observation relates to the notion of linguistic/conceptual transparency as employed in Chap. 3, the generation of number terms for powers of

¹⁰For example, instead of IIII, they used IV = V – 1; instead of XXXX, they used XL = L – X, but this shortening only occurred in mediaeval times.

¹¹The etymology of *eleven* and *twelve* is quite singular, deriving from old Norse words ‘einlief’ and ‘twalief’, meaning, respectively, ‘one-left’ and ‘two-left’ (presumably after taking away ten, a trace subtractive principle that can also be seen in Roman numeration).

¹²There is also a far greater emphasis in this community on the value of acquiring ordinal elements of counting: see Tahta (1998) or Coles and Sinclair (2017).

ten and how they relate to the standard (SI) means of writing large whole numbers using ‘Hindu-Arabic’ numerals. In Chinese, 千 (*qiān*¹³) is the character for ‘thousand’ although none is needed, as it is not in English either, based on the principle that a new power-of-ten name is only needed when the same two terms would otherwise be next to each other. ‘Ten tens’ gives rise to ‘hundred’, but ten hundreds (‘thousand’) should cause no difficulty (and does not in naming centuries, e.g. ‘the seventeen hundreds’) and need not exist, while ‘hundred hundreds’ is the next one that should generate a new term. In Chinese, that character is 万 (*wàn*), while English speakers just say ‘ten thousand’. (To belabour the point, notice it is not said as ‘ten thousands’, as conventional pluralisation rules of English would demand – though see the next section on the distinction between mass and count nouns.¹⁴) It is this same principled issue that causes divergent interpretations of ‘billion’ (‘hundred million’ in North America, ‘million million’ in the UK, at least historically): likewise with ‘trillion’. But the generation of these new words for certain powers of ten allows the use of the same number words from one to nine to be combined to name every whole number.

The SI number convention declares:

The digits of numerical values having more than four digits on either side of the decimal marker are separated into groups of three using a thin, fixed space counting from both the left and right of the decimal marker. Commas are not used to separate digits into groups of three. (<http://physics.nist.gov/cuu/Units/checklist.html>)

Thus, for example, 213 154 163 is how this number *should* be written. However, this convention makes a (false, universal) presumption in relation to every natural language on the planet with regard to the structure of number words within each language, because, as I mentioned at the outset, written numerals are not part of any natural language.

So in relation to transparency and Chap. 3’s claimed ‘perfect’ match of Chinese numeration and ‘the mathematician’s arithmetic’, this is one place where the Chinese language numeration system does not match SI at least, namely, with regard to delimiting (whether by means of commas, full stops or spaces) numerals with more than four digits. For instance, twelve thousand is written in Chinese as 一万两千元 (*yīwàn liǎngqiān*; in other words, one wàn two qiān – one ten-thousand and two thousand), which does not match 12 000. The written symbolic form of numbers can thus aid or interfere with generating the corresponding correct, language-specific spoken form.

In an article about this particular mismatch, Arthur Powell opens his account as follows:

In May and June of 1984, while conducting a series of mathematics teacher education workshops in Beijing, capital of the People’s Republic of China, I was introduced to some pedagogical problems in Chinese numeration. They involve the teaching and learning of

¹³Throughout this chapter, and indeed this volume, Hanyu Pinyin (a standardised Romanisation system for Mandarin Chinese) is used to represent Chinese characters.

¹⁴The Greek word for ten thousand – *myriad* – is used in English as a ‘round’ number word for a very large number (for much more on the linguistics of round numbers, see Channell 1994).

how to speak numerals with fluency in Chinese, using Hindu-Arabic written numerals. A salient feature of these problems manifests itself when Chinese students attempt to read numerals longer than four digits. For example, even graduates of senior middle schools find it necessary to read 6,721,394 by first pointing at and naming from right to left the place value of each digit before knowing how to read the “6” in the millionth place and the rest of the numeral. (Powell 1986, p. 20)

Powell’s proposals with regard to a way of ameliorating this difficulty in this article relate to a suggestion generated by Gattegno’s ideas of the power of pedagogic modification of certain elements of number-naming systems in order to emphasise structure:

[this proposed alternative approach] allows learners to become aware of the regularity of Chinese numeration. It also helps learners to develop strategies for by-passing reading difficulties caused by the employment of a convention of delimiting digits which is contradictory to the linguistic structure of Chinese. (p. 20)

So, by putting a space or comma after every four digits (rather than three) and reading the delimiter as *wàn*, correctly spoken Mandarin Chinese numeration follows, rather than it having to be memorised.¹⁵ But this does raise the question of where, in regard to mathematics, does a specific language ‘stop’.

Finally, I was led to wonder, *if place value can be so transparent in some systems, whether it becomes hard to think about change of base*. But I cannot go into this here. The next core element of this commentary relates to the complex issue of numerical units.

4.4 Count Nouns and Mass Nouns: The Question of Units

The motivation for exploring the issues of this section arose in part from the interesting and important discussion of number classifiers in Chinese provided in Chap. 3, but also from my simple curiosity wondering why in lots of settings English number words have features of nouns that reflect both singular and plural forms: for instance, in the everyday expression ‘hundreds and hundreds’ compared with ‘two hundred (and) fifty-three’. Or, the spoken number following ‘ninety-nine’ is ‘one hundred’ or ‘a hundred’, yet the number following one hundred ninety-nine is ‘two hundred’). Why is it that ‘hundred’, when used as a power-of-ten unit, is singular (e.g. two hundred and forty-two, rather than two-hundreds and forty-two)? Why do number words put pressure on the straightforward singular/plural distinction in English? How does this play out in the units for the countable noun and are numbers themselves such units? As Wittgenstein observed, ‘Grammar tells what kind of

¹⁵To illustrate how devastating this can be, I noticed today that my ticket for the Vancouver SkyTrain has a twenty-digit identification number, presented in groups of four: 0001 1570 5839 8568 8326. Had I to read this aloud as a single number (were I concerned, say, about its cardinality), rather than as simply a string of digits with a pause for each space, I would be rendered speechless.

object anything is’ (Wittgenstein 1953, p. 116); hence, this uncertainty (present also in singular or plural verbs) potentially reflects an ontological instability at the heart of (English-language) number.

The earlier discussion of Dienes blocks and the paper tabular presentation also had column headings that were called ‘thousands’, ‘hundreds’, ‘tens’ and ‘units’. Yet once numerals were used to replace the (multiple) blocks, the differentially marked plural forms vanished in both the corresponding spoken and written English. (With regard to fractions words in English, not least the question of whether ‘three-fifths’ is a singular or plural noun and how it differs syntactically from ‘three fifths’, see the next section.)

In order to pursue some of the challenges that were mentioned in the previous section, I wish to examine certain morphosyntactic aspects of number words in English. One broad distinction in English grammar (which has commented upon in the literature since at least the early 1900s¹⁶) is the distinction between count nouns and mass nouns (the latter is sometimes referred to as ‘non-count’ nouns, though the two categories are not the same – see Laycock 2010), albeit one currently eroding (as is the case with round numbers) in interesting ways.

Edward Wisniewski begins his chapter on the potential cognitive basis for such a distinction as follows:

English and other languages make a grammatical distinction between count nouns and mass nouns. For example, “dog” is primarily used as a count noun, and “mud” is primarily used as a mass noun. Count nouns but not mass nouns can be pluralized and preceded by numerals (as in “three dogs” but not “three muds”). Count nouns but not mass nouns can appear with the indefinite determiner “a” (as in “A dog ate the chicken” but not “A mud covered the chicken”). On the other hand, mass nouns can appear with indefinite quantifiers, such as “much” or “little” (as in “much mud” but not “much dog”), whereas count nouns can appear with indefinite quantifiers such as “many” and “few” (as in “many dogs” but not “many muds”).¹⁷ (2010, p. 166)

There are many things to be said about this distinction. One key observation concerns the potential that any English noun, in certain circumstances, can come to take on both count and mass aspects, rather than, as suggested above, that these are two disjoint noun categories. This is also marked by the failing distinction between *fewer* (count) or *less* (mass), likewise *many* and *much*. In a mathematics context, this flexibility can be seen in the nineteenth century with the terms ‘algebra’ or ‘geometry’, where mathematical developments (non-Euclidean geometry, Boolean algebra) subsequently enabled ‘an algebra’ or ‘two geometries’ to be spoken of (and related to highly significant shifts in the perception of the underlying mathematics being referred to). In the late twentieth century, ‘technology’ has morphed to allow

¹⁶This distinction is certainly not limited to English but is far from universally employed across languages. In particular, the various forms of Chinese do not distinguish these categories, instead using classifiers as described in Chap. 3.

¹⁷There is a footnote in Wisniewski’s chapter at this precise point, which begins, ‘Some languages such as classifier languages (e.g. Japanese) do not make a distinction between count and mass nouns. Nevertheless, they do have mechanisms for indicating that an entity is or is not individuated’. As explored at length in Chap. 3, Chinese is also a classifier language.

‘a technology’ or ‘digital technologies’. All instances of conventionally mass nouns admit count possibilities and characteristics, and vice versa.¹⁸

A second observation has to do with the way that mass nouns are quantified: traditionally, this was by using various instances of the ‘a unit of’ construction (e.g. ‘a slice of’ or ‘a loaf of’ bread, ‘a grain of’ rice), where the unit could always be quantified, i.e. was itself a count noun. (Though, contrariwise, seeing four as ‘a quartet of’¹⁹ permits all count nouns to be seen as mass nouns – albeit in the plural form – where the number words themselves can be quantified: two quartets of, three septets of, and so on.²⁰)

However, the most educationally significant thing by far that this distinction relates to in regard to this chapter and the previous one is the extent to which number words themselves (in English or other languages), when functioning as nouns (as they do in arithmetic), do so as mass or count nouns. This is centrally related to the passing comments I have repeatedly made so far about whether it should be ‘hundred’ or ‘hundreds’.

In the specific context of this chapter, however, my interest lies with English number words themselves in their nominal form, one, two, three, etc., and the corresponding ordinals, first, second, third (which may or may not function as nouns), and the somewhat bewildering connection in some languages between ordinals and fraction terms (see Pimm and Sinclair 2015, as well as the next section). With all of these sets of number words, the question is: mass or count?

Consider the English word count sequence ‘one, two, three, etc.’. One of the ambiguities in English in respect of multiplication has to do with whether it ‘should be’ four twos *is* or four twos *are* eight.²¹ Notice the distinct pluralisation of ‘two’ marks it as a count noun, as does the ‘count’ word ‘four’, as does the verb agreement of ‘are’ with the pluralised noun form ‘twos’. The presence of a count noun permits the question ‘How many?’ to be asked in relation to it (for much more on this, see Sinclair and Pimm 2015a). Yet in the count sequence one, two, three, etc., the number words act more like mass nouns. And, as always, *what cognitive shifts or chasms underlie such linguistic uncertainties?*

Look at the ordinal terms: first, second, third, fourth, etc. While it is possible to imagine scenes where a count noun perspective is possible (e.g. in an athletic meeting, asking a runner: how many firsts, and how many seconds?, meaning first places and second places), these act more like mass than count nouns. But notice what happens when we shift to the related fraction forms: again, we get two sevenths and

¹⁸As a potential example of nouns going the other way, consider ‘I returned to the car and there was bird all over the windshield’, though this also could be seen as an anti-synecdoche, using the whole for the part.

¹⁹With regard to Ancient Greece, David Fowler refers to *arithmoi* as cardinals, but helpfully observes, ‘a much more faithful impression of the very concrete sense of the Greek *arithmoi* is given by the sequence: duet, trio, quartet, quintet, ...’ (Fowler 1987, p. 14).

²⁰Cf T. S. Eliot’s *Four Quartets* as well as the earlier mention of Fowler and *arithmoi*, specifically in the previous footnote.

²¹Though here the question, in relation to the calculator and what is said when pressing the ‘=’ button, is perhaps whether the verb should not be ‘is (are)’ but rather ‘make(s)’ or ‘give(s)’.

three tenths, which are plural and count nouns (and would encourage this syntax for statements like ‘two sevenths *are* bigger than three tenths’). But then the unifying hyphen may show up (two-sevenths, three-tenths), with the effect of singularising these composite forms.²²

Once again, this section simply contains some brief comments and observations about number language in certain contexts. In the next section, I move towards aspects of a range of number word systems.

4.5 Cardinal, Ordinal and Fractional: Three Interlocking Linguistic Subsystems

Whole numbers are not the only game in town. Languages also have systematic ways of naming (of summoning, of calling into being) ordinals and fractions (decimals or otherwise) as well. Most of what follows specifically concerns the English language, though a more diverse discussion (concerning some twenty different languages) can be found in Pimm and Sinclair (2015), which explored variations among these three sets of number words across a variety of languages and language groups. The motivation to do so arose from the two papers in *For the Learning of Mathematics* (Bartolini Bussi et al. 2014; Pimm 2014), most specifically in relation to close links (in some languages near identical) between how ordinal words and fraction words are formed (and why this might be).

In an attempt to summarise some of what was found, here are four diagrams that reflect different relationships among cardinal (C), ordinal (O) and fraction (F) words within specific languages from my dataset. The arrows indicate ‘adding’ a suffix to the previous sets of words to form the new set. Figure 4.4(a) captures, e.g. Norwegian, while (b) exemplifies one common relationship (e.g. German): (c) is the ‘degenerate’ case of (b) that fits some Western European languages (e.g. English, French, Italian and Spanish), while (d) reflects Hungarian.

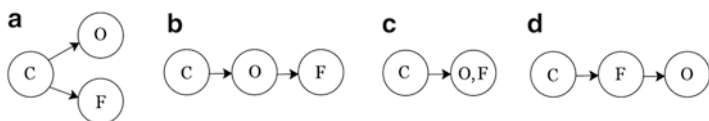

Fig. 4.4 (a–d) Various relationships among sets of number words within a single natural language

²²Pedagogically, Hewitt (2001, pp. 47–8) explores fraction operations based primarily on linguistic parallels between invented non-number noun names (that he gives compound number name patterns to, such as ‘flinkerty-floo’ or ‘zipperly-bond’) and number nouns, asking not only ‘how many twenty-fourths are there in one?’ and ‘how many four-hundred-and-twentieths are there in nine?’ but also ‘how many flinkerty-flooths are there in one?’ and ‘how many flinkerty-flooths are there in zipperly-bond?’. Note his use of ‘How many?’ questions and plural number nouns and plural verbs throughout.

As I mentioned at the outset, one question I was led to examine was how these naming systems relate one to another within a given language, as well as how they relate to gestures on the one hand and to trans-linguistic written numerals on the other. Ordinality primarily concerns the sequential aspect of whole numbers, as opposed to their quantitative (cardinal) one. And there is a key and fundamental question about which came first, cardinal or ordinal. (For much more on this, see Seidenberg 1962 and Sinclair and Pimm 2015a.) But spoken ordinal terms carry a significant difference from cardinal terms in that the core issue becomes which one comes before or is said before or after another, rather than which one is bigger or smaller. Thus, ordinality is strongly related to temporality rather than magnitude.

Here are two minute observations. First, there is a commonly employed, hybrid written notation that seems both to pull ‘Hindu-Arabic’ numerals into a specific language and to privilege the cardinal over the ordinal: 1st, 2nd, 3rd, 4th, 5th, etc. (even though in French it is 1^{er}, 2^{ième}, 3^{ième}, 4^{ième}, 5^{ième}, etc.). The second one is specific to English and relates to the supposed cardinal counting decade words: both ‘thirty’ and ‘fifty’ show explicit ordinal over cardinal traces – ‘thir-ty’ as the third ‘-ty’, ‘fif-ty’ as the fifth ‘-ty’ – a visible (and audible) trace, not least because of the distinction between the English words ‘three’ and ‘third’ and ‘five’ and ‘fifth’ (from the two closely related English language systems of cardinal and ordinal words), whereas neither ‘four’ and ‘fourth’ exactly ‘fit’ ‘forty’.

There is an ordinal regularity in English after five, both of forming ordinals ‘from’ cardinals and the presumed economy (and greater ease of pronunciation) of potentially dropping the ‘-th’ suffix from a possible, historical *sixthty*, *seventhty*, *eighthty* and *ninethty*. But in regard to my discussion in Pimm (2014) of ‘the fifth part’ (in regard to the singularity of unit fractions in Ancient Egyptian arithmetic), there is some appreciable specificity implied, in that ‘the sixthty’ (seen as ‘the sixth ‘-ty’’) would have to be unique and ‘a sixthty’ or ‘two sixthtys’ would not be feasible.

4.6 A Few Concluding Remarks

The main focus of this commentary piece has been to draw attention to certain features of number language, both language-specific ones (mostly in regard to English) and across certain classes of language (in terms of the presence or absence of certain distinctions, such as mass/count or classifiers) that may have some pertinence or significance in learning to number and to count. But underneath it has been an attempt to keep an ear and an eye out for ‘traces’ (‘memories’ in the terminology of Chap. 3) of what has passed before or en route (both within individuals and within cultures) to our present-day set of practices and forms with regard to number.

In particular, in my attempt to localise place value away from natural language and primarily into written symbolic notation systems (though it is important not to forget physical manifestations of the same, such as with *kipu* – see Chrisomalis

2009), I have endeavoured to make distinctions among the interlinked systems of language, notation and the world. In regard to mathematics education, far more generally, the potential overvaluing of cardinal number as the pedagogically presumed dominant form with regard to arithmetic and mathematics has some serious consequences, as has the consequent downplaying of ordinality and its significant role in learning how to count (see Tahta 1991, 1998; Sinclair and Pimm 2015a, b; Coles 2017).

In Fig. 4.5, there is my first attempt at trying to depict this (even though I already can see problems, oversimplifications, omissions and errors). It draws on the distinction between metaphoric and metonymic relations, as outlined in Tahta (1991, 1998), which he links with the abacist and the algorist, respectively: the use of physical objects (which become metaphors for number) versus the ‘manipulation’ of numerals.

Tahta writes:

Metaphor and metonymy are not necessarily distinct polarities, but more like aspects that can be stressed or ignored as desired. One of our problems in teaching arithmetic is the move from the stress on metaphor to the stress on metonymy. We offer children counters and rods and so on, in order to mimic processes which we eventually want them to transfer to written or spoken numerals. (1998, p. 6)

As an individual becomes more and more numerically fluent, the separation between number words and numerals becomes less and less: but this does not mean that those distinctions and separations cease to leave their traces.

One final observation: Chrisomalis’s (2010) fascinating book on the history of numerical notation is over five hundred pages long. The world and its (linguistic) history in regard to whole number is a very complex and sophisticated mix. But also an engaging and, at times, fascinating one.

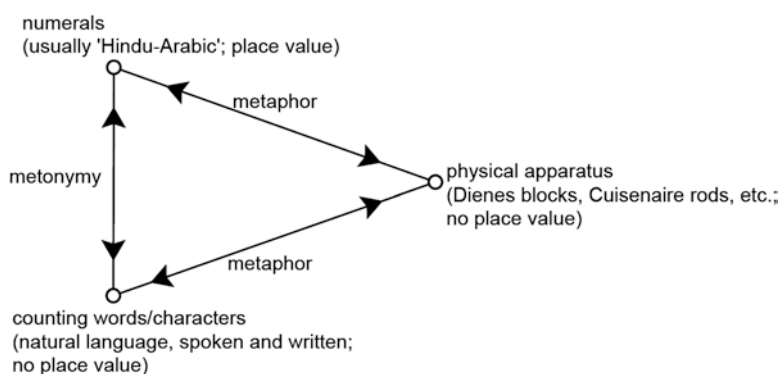

Fig. 4.5 Metaphor and metonymy in relation to the interlinked systems of natural language, notation and the world

References

- Bartolini Bussi, M., Baccaglioni-Frank, A., & Ramploud, A. (2014). Intercultural dialogue and the geography and history of thought. *For the Learning of Mathematics*, 34(1), 31–33.
- Bender, A., & Beller, S. (2012). Nature and culture of finger counting: Diversity and representational effects of an embodied cognitive tool. *Cognition*, 124, 156–182.
- Channell, J. (1994). *Vague language*. Oxford: Oxford University Press.
- Chrisomalis, S. (2009). The cognitive and cultural foundations of numbers. In E. Robson & J. Stedall (Eds.), *The Oxford handbook of the history of mathematics* (pp. 495–517). Oxford: Oxford University Press.
- Chrisomalis, S. (2010). *Numerical notation: A comparative history*. Cambridge: Cambridge University Press.
- Coles, A. (2014). Transitional devices. *For the Learning of Mathematics*, 34(2), 24–30.
- Coles, A. (2017). A relational view of mathematical concepts. In E. de Freitas, N. Sinclair, & A. Coles (Eds.), *What is a mathematical concept?* (pp. 205–222). Cambridge: Cambridge University Press.
- Coles, A., & Sinclair, N. (2017). Re-thinking place value: From metaphor to metonym. *For the Learning of Mathematics*, 37(1), 3–8.
- Dienes, Z. (1963). *An experimental study of mathematics learning*. London: Hutchinson.
- Fowler, D. (1987). *The mathematics of Plato's academy: A new reconstruction*. Oxford: Oxford University Press.
- Gattegno, C. (1974). *The common sense of teaching mathematics*. New York: Educational Solutions.
- Hewitt, D. (1999). Arbitrary and necessary part 1: A way of viewing the mathematics curriculum. *For the Learning of Mathematics*, 19(3), 2–9.
- Hewitt, D. (2001). Arbitrary and necessary: Part 3 educating awareness. *For the Learning of Mathematics*, 21(2), 37–49.
- Jackiw, N. & Sinclair, N. (2014). *Touch counts* [software application for the iPad]. <https://itunes.apple.com/ca/app/touchcounts/id897302197?mt=8>
- Kim, R., & Albert, L. (2014). The history of base-ten-blocks: Why and who made base-ten-blocks? *Mediterranean Journal of Social Sciences*, 5(9), 356–365.
- Lakoff, G., & Núñez, R. (2000). *Where mathematics comes from: How the embodied mind brings mathematics into being*. New York: Basic Books.
- Laycock, H. (2010). Mass nouns, count nouns, and non-count nouns: Philosophical aspects. In A. Barber & R. Stainton (Eds.), *Concise encyclopedia of philosophy of language and linguistics* (pp. 417–421). Amsterdam: Elsevier.
- Núñez, R. (2009). Gesture, inscriptions, and abstraction: The embodied nature of mathematics or why mathematics education shouldn't leave the mathematics untouched. In W.-M. Roth (Ed.), *Mathematical representation and the interface of body and culture* (pp. 309–328). Charlotte, NC: Information Age Publishing.
- O'Daly, I. (2014). *Talk to the hand: Finger counting and hand diagrams in the Middle Ages*. <https://medievalfragments.wordpress.com/2014/03/14/talk-to-the-hand-finger-counting-and-hand-diagrams-in-the-middle-ages/>
- Pimm, D. (1987). *Speaking mathematically: Communication in mathematics classrooms*. London: Routledge and Kegan Paul. (To be reissued in 2017.)
- Pimm, D. (1995). *Symbols and meanings in school mathematics*. London: Routledge.
- Pimm, D. (2014). Unthought knowns. *For the Learning of Mathematics*, 34(3), 15–16.
- Powell, A. (1986). Economizing learning: The teaching of numeration in Chinese. *For the Learning of Mathematics*, 6(3), 20–23.
- Rotman, B. (1987). *Signifying nothing: The semiotics of zero*. London: Macmillan.
- Seidenberg, A. (1962). The ritual origin of counting. *Archive for History of Exact Sciences*, 2(1), 1–40.

- Setati, M. (1998). Code-switching in a senior primary class of second-language mathematics learners. *For the Learning of Mathematics*, 18(1), 34–40.
- Sinclair, N., & de Freitas, E. (2014). The haptic nature of gesture: Rethinking gesture with new multitouch digital technologies. *Gesture*, 14(3), 351–374.
- Sinclair, N., & Pimm, D. (2015a). Whatever be their number: Counting on the visible, the audible, and the tangible. In M. Meletiou-Mavrotheris, K. Mavrou, & E. Paparistodemou (Eds.), *Integrating touch-enabled and mobile devices into contemporary mathematics education* (pp. 50–80). Hershey, PA: IGI Global.
- Sinclair, N., & Pimm, D. (2015b). Mathematics using multiple senses: Developing finger gnosis with three- and four-year-olds in an era of multi-touch technologies. *Asia-Pacific Journal of Research in Early Childhood Education*, 9(3), 99–110.
- Tahta, D. (1991). Understanding and desire. In D. Pimm & E. Love (Eds.), *Teaching and learning school mathematics* (pp. 221–246). London: Hodder and Stoughton.
- Tahta, D. (1998). Counting counts. *Mathematics Teaching*, 163, 4–11.
- Wisniewski, E. (2010). On using count nouns, mass nouns, and *pluralia tantum*: What counts? In F. Pelletier (Ed.), *Kinds, things, and stuff: Mass terms and generics* (pp. 166–190). Oxford: Oxford University Press.
- Wittgenstein, L. (1932). *Culture and value* (P. Winch, Trans.). Chicago: University of Chicago Press.
- Wittgenstein, L. (1937/1976). Cause and effect: Intuitive awareness. *Philosophia*, 6(3–4), 409–425.
- Wittgenstein, L. (1953). *Philosophical investigations* (G. Anscombe, Trans.). Oxford: Blackwell.
- Ziman, J. (1978). *Reliable knowledge: An exploration of the grounds for belief in science*. Cambridge: Cambridge University Press.
- Zwicky, J. (1992). *Lyric philosophy*. Toronto: University of Toronto Press.

Cited papers from Sun, X., Kaur, B., & Novotna, J. (Eds.). (2015). Conference proceedings of the ICMI study 23: Primary mathematics study on whole numbers. Retrieved February 10, 2016, from www.umac.mo/fed/ICMI23/doc/Proceedings_ICMI_STUDY_23_final.pdf

Pimm, D., & Sinclair, N. (2015). The ordinal and the fractional: Some remarks on a trans-linguistic study (pp. 354–361).

Open Access This chapter is licensed under the terms of the Creative Commons Attribution 4.0 International License (<http://creativecommons.org/licenses/by/4.0/>), which permits use, sharing, adaptation, distribution and reproduction in any medium or format, as long as you give appropriate credit to the original author(s) and the source, provide a link to the Creative Commons license and indicate if changes were made.

The images or other third party material in this chapter are included in the chapter's Creative Commons license, unless indicated otherwise in a credit line to the material. If material is not included in the chapter's Creative Commons license and your intended use is not permitted by statutory regulation or exceeds the permitted use, you will need to obtain permission directly from the copyright holder.



Part II
Working Group Chapters
and Commentaries

Chapter 5

The What and Why of Whole Number Arithmetic: Foundational Ideas from History, Language and Societal Changes



Xu Hua Sun , Christine Chambris 
Judy Sayers, Man Keung Siu, Jason Cooper , Jean-Luc Dorier ,
Sarah Inés González de Lora Sued , Eva Thanheiser , Nadia Azrou ,
Lynn McGarvey , Catherine Houdement , and Lisser Rye Ejersbo 

5.1 Introduction

Mathematics learning and teaching are deeply embedded in history, language and culture (e.g. Barton 2008). Yet what historical, linguistic and cultural foundations are necessary for the early years of school to adequately prepare children for mathematics learning? To address this question, we summarise work on these three aspects of WNA to frame the entire volume and identify the historical, linguistic and cultural bases on which other aspects of learning, teaching and assessment are based. The chapter provides a meta-level analysis and synthesis of what is known about WNA's foundations of history, language and societal changes, which serves as a useful base from which to gauge any gaps and omissions. This foundation also

The first author was supported by the Research Committee, University of Macau, Macao, China (MYRG2015-00203-FED). The opinions expressed herein are those of the authors.

The first two authors wrote the chapter with the collaboration of other working group members.

X.H. Sun (✉)

Faculty of Education, University of Macau, Macao, China

e-mail: xhsun@umac.mo

C. Chambris (✉)

Laboratoire de didactique André Revuz, Université de Cergy-Pontoise, Cergy, France

e-mail: christine.chambris@u-cergy.fr

J. Sayers

Stockholm University, Stockholm, Sweden

M.K. Siu

University of Hong Kong, Pokfulam, Hong Kong, China

© The Author(s) 2018

M.G. Bartolini Bussi, X.H. Sun (eds.), *Building the Foundation: Whole Numbers in the Primary Grades*, New ICMI Study Series, https://doi.org/10.1007/978-3-319-63555-2_5

provides an opportunity to learn from the practices of different times and languages and from societal changes.

5.1.1 Conference Presentations: Overview

Thirteen papers written by authors from 11 countries were presented for Theme 1. For presentation and discussion, these papers were divided into four subgroups exploring several overlapping aspects of the why and what of WNA: the historic background of WNA, the language foundations of WNA, the foundational ideas that underlie WNA and the support for societal changes to the teaching and learning of WNA.

5.1.1.1 Historical Background

Zou (2015) summarised findings from historical investigations of arithmetic in ancient China, including how number units were derived and named and how numbers were represented with rod or bead calculation tools and with symbols. Siu (2015) studied the book of *Tongwen Suanzhi* (同文算指) (Rules of Arithmetic Common to Cultures, 1614) and reviewed how counting rods and the abacus were gradually replaced with written calculations in China. Sun (2015), also discussing early Chinese development, presented the use of advanced number names and

J. Cooper
Weizmann Institute of Science, Rehovot, Israel

J.-L. Dorier
University of Geneva, Geneva, Switzerland

S.I.G. de Lora Sued
Pontificia Universidad Católica Madre, Santiago de los Caballeros, República Dominicana

E. Thanheiser
Portland State University, Portland, OR, USA

N. Azrou
University Yahia Fares Medea, Medea, Algeria

L. McGarvey
University of Alberta, Edmonton, AB, Canada

C. Houdement
Laboratoire de didactique André Revuz, Université de Rouen-Normandie, Rouen, France

L.R. Ejersbo
Aarhus University, Aarhus, Denmark

calculation tools (counting rods and the *suàn pán* or Chinese abacus) and emphasised how place value is still the most overarching principle of WNA based on Chinese linguistic habit. Traces of this influence can still be found in contemporary core curriculum practices in many countries today.

5.1.1.2 Language Foundation of WNA: Regularity, Grammar and Cultural Identity

Azrou (2015) reported how the historical and linguistic colonisation of Algeria affected the learning of WNA and presented the first step of an intervention for teacher education, which can also promote students' cultural identities. Chambris (2015) showed how changes related to place value that were introduced by the New Math in France (1955–1975) continue to be influential today.

Houdement and Tempier (2015) reported on two experiments for strengthening the decimal (base ten) principle of numeration, assigning a key role to the use of numeration units in France. Changsri (2015) explored first grade students' ideas of addition in two Thai schools in the context of lesson study and an open approach and found that the students used a variety of representations to express addition ideas.

5.1.1.3 Foundational Ideas Underlying WNA

Dorier (2015) gave an overview of the development of numbers, showing how Brousseau's theory can be used in accordance with this historical context to develop the key stages of a teaching sequence using the concept of numbers. Thanheiser (2015), also studying teacher education, adopted the perspective of variation theory and used historical number systems as a tool, finding that prospective teachers developed a more sophisticated concept of the base-ten place value system by examining, comparing and contrasting different aspects of historical systems. Ejersbo and Misfeldt (2015) described research introducing a regular set of number names in primary schools in Denmark. Sayers and Andrews (2015) summarised an eight-dimensional framework called foundational number sense (FoNS) that characterises necessary learning experiences for young children. They demonstrated how to use the framework by analysing learning opportunities in first grade in five European contexts.

5.1.1.4 Different Expected Learning and Teaching Goals for WNA

Cooper (2015) discussed how a university mathematician and a group of elementary school teachers, working together in a professional development course, revealed new insights into division with remainders. McGarvey and McFeetors (2015)

identified the Canadian public's concerns about the goals of WNA and the support required for students to reach them.

5.1.2 Working Groups' Discussions

The eight one-hour sessions were organised in different ways. Examining variation in WNA across history and language and across different communities, working group 1 discussed the implications of different views on the why and what of WNA for instruction and teacher education. Place value in the so-called Hindu-Arabic system was discussed extensively in the working group sessions. In addition to the background discussion and questions posed in the Discussion Document (this volume, [Appendix 2](#)), the papers for Theme 1 can facilitate discussions of the following questions:

1. How has the place value concept developed across numeral systems?
2. What are the issues of language and culture in WNA?
3. How did/do different communities change past/current teaching of WNA?

5.1.3 The Structure of This Chapter

This chapter describes number representations and their foundational ideas beyond the variations in WNA across history, language and culture. As the world becomes more unified and previously separate cultures interact and begin to merge, incompatibilities become visible and separations arise between different traditions and practices. Many of these incompatibilities can be seen in WNA. Particularly notable is the accommodation needed when traditional language is adapted to deal with the nearly universal decimal place value system for naming and calculating. Approaches to instruction and teacher education are affected by these incompatibilities, as this chapter discusses.

Historical evolution can provide a deeper understanding of the past and present in science as a means of consolidating and clarifying foundations (e.g. Jankvist 2009). We begin with a historical survey of the numeration knowledge development of pre-numeral systems and the conceptual development of numeral systems. We then track the foundational epistemological and pedagogical insights from history. Section 5.2 highlights the differences between cultural practices, especially language, and their links with the universal decimal features of WNA. Post-colonial tensions, where the inconsistency between spoken and written numbers and the incompatibility between numeration and calculation appear, are also explored. Section 5.3 discusses the influence of multiple communities within societies throughout history when attempts at changes are made. Different stakeholder groups in a given society may hold different goals for WNA and thus create different expect-

tations and support within the society. Various examples are given and key comparisons are made, especially for understanding how and why curricula change.

In parallel with tendencies towards teaching mathematics in globalised ways, a shared awareness has recently evolved among teachers and researchers about the nature of mathematics through the study of its history, traditions and culture. By 'culture', we mean a set of meanings that have been historically constructed, socially transmitted and continually modified and that are embodied in our symbols and language (e.g. Barton 2008). Through this set of meanings, people communicate, perpetuate and develop their knowledge and understanding of life (see also this volume, Chaps. 3 and 9). History and culture shape not only number names and concepts but also the use of numbers in measurement and operations. Different languages have their own syntax and semantics, which emphasise different aspects of numbers; these may foster or hinder a deep understanding of number concepts, especially ideas about base ten, place value and operations. While a purpose of education is to support the continuity of the structures and functions that are unique to a culture and to maintain cultural identity (e.g. Leung et al. 2006), local cultures need to link to universal cultures to avoid isolation in global development. A critical issue, then, is how a cultural system reflects on its own history, language and culture, identifies the disadvantages and advantages of its system, and overcomes its disadvantages and promotes its advantages. What lessons do we learn from these reflections and from the interventions that are based on them?

5.2 Foundational Ideas that Stem from History

5.2.1 *Introduction: The Hindu-Arabic Numeral System*

According to some historians, the story of the Hindu-Arabic system (e.g. Lam and Ang 2004) is derived from the Chinese story. See (Chemla 1998) for a different historical perspective and more details in this volume, Chap. 3. This system and its use, which was systematically presented in the Sunzi Suanjing, was transmitted through India during the fifth to ninth centuries, to the Arab Empire in the tenth century and then to Europe in the thirteenth century via the Silk Road (see Guo 2010). Mathematics historians have debated the origins of the Hindu-Arabic numeral system for years. For example, French mathematics historian Georges Ifrah (2000) argued that as the Brahmi notation of the first nine whole numbers was autochthonous and free of any outside influence, the decimal place value system must have originated in India and was the product of Indian civilisation alone. In contrast, Lam and Ang (2004) argued that there is no early Indian text or evidence to show that it was used earlier there than in China. Early texts and evidence show that the Chinese used the rod numeral system continuously for almost 2000 years. This historical fact is not well known in either the Western or Eastern communities of math education because of the limited dissemination of the conceptualisation history of place value of the Hindu-Arabic system.

According to Lam and Ang (2004), in Western Europe, before the advent of the Hindu-Arabic numeral system, few mathematicians would have been able to perform multiplication. In contrast, in ancient China, the operation of multiplication would have been commonly known as far back as the Warring States period (475–221 BCE), not only among mathematicians but also among officials, astronomers, traders and others. This could be because the Chinese rod number system used the concept of place value. It is not surprising that the *Nine Chapters on the Mathematical Art* includes common fractions, areas, the rule of three, least common multiple, extraction of square and cube roots, volumes, proportion and inverse proportion, relative distance and relative speed, surplus and deficit, rule of false position, the matrix notation, negative numbers, simultaneous linear equations and right-angle triangles because it was grounded in the advanced decimal place value system (Chemla, 2007).

A culture's arithmetic development may be confined or promoted by the numeral system used. For example, multiplication with large numbers could not be well supported by a simple tally system. The Hindu-Arabic numeral system is much more complex than others: it includes a principle for naming numbers, which is ten based with multiple units, and the additive and multiplicative relationships are embedded implicitly, with only the digits recorded. It is universally used in the world because every number, however large, can be easily represented and computations can be easily realised.

According to the Discussion Document (this volume, [Appendix 2](#)), historical reconstruction was in the foreground of WNA. For a better understanding of this system, a brief conceptual development of the numeral system¹ is examined, and associated epistemological and pedagogical analyses are carried out below. This study has two motivations: to understand the foundations of established whole number arithmetic (product) by studying the historical origins (process) and to provide insights for modern teaching by investigating epistemological obstacles (this volume Chap. 9, esp. Sect. 9.3.2). Jankvist (2009) argued that 'history can not only help to identify these obstacles, it can also help to overcome them: an epistemological reflection on the development of ideas in the history can enrich didactical analysis by providing essential clues which may specify the nature of the knowledge to be taught, and explore different ways of access to that knowledge' (p. 237).

We examine the foundational idea of number representation development and do not describe all of the historical facts. The conceptual development of numeral systems can be classified into four types based on conceptual development progress: the tally system, additive system, multiplicative-additive system and decimal place value system. In each case, different strategies to realise operations were invented; these are explained below. Progress could better mirror the development of number structuring and some epistemological obstacles in history/learning (e.g. Jankvist, 2009).

¹A numeral system (or system of numeration) is a writing system for expressing numbers – that is, mathematical notation for representing numbers of a given set using digits or other symbols in a consistent manner.

5.2.2 *Knowledge of Pre-numeral Systems*

5.2.2.1 **Early Numeration Practices**

Many anthropologists (e.g. Ifrah 2000; Menninger 1969) have found that some ancient cultures did not develop numbers at all. Some had names only for one and two and some up to three or four. Larger numbers were described as ‘many’. In many ancient languages, words for ‘two’ or ‘three’ exist between singular and plural as a means to distinguish one from many, which is the beginning stage of the development of numeration.

One-to-one correspondence between an organised list of words – that is, the list of number names – and the units of a collection is typically considered an elementary process in counting, and it is the most fundamental stage. In many cultures (e.g. Menninger 1969), parts of the human body have been used to make one-to-one correspondence, often starting with fingers. Despite having limited sets of number names, some cultures developed quantitative practices that go beyond the greatest number available, such as the use of tally systems, and partitioned large quantities into smaller countable quantities (Baxter 1989). A society’s early numerical practices are embedded in its development of a tally system, which is built on ordinal numbers, cardinal numbers and the counting principle – namely, one-to-one correspondence (Seidenberg 1962). Beyond tally numeral systems, various cultures developed different numeration systems, yet all had in common a symbol for one, the unit of ones and other symbols for collections of that unit (May 1973).

5.2.2.2 **The Invention of the Counting Principle**

Knowing whether quantities have increased or decreased was likely a key problem for many ancient tribal peoples. To recognise more or fewer, one of the earliest methods directly stimulated the invention of one-to-one correspondence with an intermediate collection of stones (Dorier 2015). Before representing and naming numbers, people developed several ways to evaluate quantities beyond rough estimation. For example, we can imagine that shepherds were concerned about the possibility of losing sheep when they returned from the fields at night. We can only speculate how the use of stones became tokens in one-to-one correspondence, but there is clear evidence that tokens were used in one-to-one correspondence by the use of ‘envelopes holding counters to represent sets’ of numbers (Schmandt-Besserat 1992, p. 190). Illustrations of artefacts were used to form records of number of tokens as representations. Several other artefacts, some dating to Palaeolithic times (15,000 BCE), such as notches and bones, are indicators of human activity related to the building of corresponding collections with specific cardinal numbers to record quantities. This may have been the beginning of the invention of the counting principle.

5.2.2.3 The Pre-structures of Number Naming

Because of rhythmic demands of oral pronunciation, no language represents numbers by articulating the same sound more than two times. That is, there are no known examples such as ‘one one one one’ for four or ‘three three three’ for nine. Words are sometimes repeated but not more than once (Cauty 1984; Guitel 1975). This implies that number names are not based on the principles of a tally system (a numeration system of keeping a record of quantities and amounts by using single strokes to represent the objects being counted) (see Sect. 5.2.2 and this volume Chaps. 9 and 10). If number names exist in a given language, the list of the names of the smallest numbers is a sequence of words that is more or less long, and the words are more or less independent. Conversely, if a given language presents number names for large numbers, sequences of number names beyond a threshold always have a multiplicative structure. The threshold is almost always under 100 (Cauty 1984; Crump 1990; Menninger 1969). In Chinese, and other languages such as Chunks (González and Caraballo 2015), the threshold is ten.

We consider the sequence before the threshold, as its structure is of interest. Cauty (1984) identified several types of sequences within spoken numbers:

1. Ordinal – a list of words independent of each other.
2. Ordinal with benchmarks – as described above, it begins with a list of words and is followed by benchmarks on a scale, e.g. the Panare language has benchmarks for 5, 10, 15 and 20 and counts from 1 to 4 between the benchmarks (Cauty 1984).
3. Cardinal with addition – where a number is represented by juxtaposed number names whose sum is the given number (such as how XXIII means two 10s and three 1s in Roman numerals).
4. Cardinal with multiplication – where a number is represented as a sum of products of small numbers (‘digits’) times units (such as how three hundred two means three times one hundred and two in Chinese spoken and written numerals).

The Oksapmin people (Saxe 1981) use body parts to recognise numbers, moving from the right-hand fingers up to the right eye – the first finger is 1 and the eye is 13. The nose is 14, and they move symmetrically from the left eye to the left-hand fingers to count from 15 to 27. This can be considered a long ordinal list. According to Cauty (1984), the ordinal-with-benchmarks type above is often confused with the cardinal type with addition/multiplication. The difference between the two lies in the grammar, which indicates movement in relation to the benchmarks. Benchmark and additive numeration may be the beginning of the idea of a base (as in base ten). However, in some languages, the names of larger numbers may be expressed in terms of smaller numbers and arithmetic operations, which may be the beginning of the exploration of number structure, e.g. $3 = 2 + 1$ and $5 = 2 + 2 + 1$, and even multiplicative forms such as $6 = 2 \times 3$ and $18 = 3 \times 6$. However, it is rare for 2 to be expressed as $1 + 1$ (Crump 1990). In Nigeria, the Yoruba numeral system is based on 20, and other numbers may be expressed by subtraction, e.g. $35 = (20 \times 2) - 5$.

This can also be seen in Roman numerals, where, for example, CX means 110, but XC means 90.

To meet the need for counting, various cultures developed the counting principle and one-to-one correspondence and named numbers with some regularity, sometimes using addition and/or multiplication, to specify quantity. From these practices, we can learn about the conceptual development of number systems, as naming and operations (addition/multiplication) were developed at the same time. The counting principle, invented number names and written number symbols are needed for the development of a formal numeral system. However, the coordination between cardinal numbers and ordinal numbers could be considered too trivial, too easy to explicitly design in many curricula and lessons. These could be reasons for long-term learning difficulty in later number development and operations.

5.2.3 *The Conceptual Development of Numeral Systems*

5.2.3.1 Tally Systems

The Ishango bone² notches (about 18,000 to 20,000 BCE), ancient Chinese knots in string and Sumerian marks on a clay tablet show what appear to document quantity as an ‘early stone or agricultural age’ vision of numerals (Mainzer 1983/1991) in almost all ancient cultures (see also Sect. 9.2.2). Ifrah (2000, p. 64) points out that tally systems could be an early vision of systematic counting numbers ‘first used at least forty thousand years ago’. These could be the origins of Roman or Etruscan numerals (Ifrah 2000, pp. 191–197). Such marks clearly point to the development of ancient written number representations. Tally numeral systems are among the most primitive means of recording quantity (Hodgson and Lajoie 2015). Counting up and down might be the natural calculation of sums and differences. It is the simplest (unary) numeral system, and it plays an important role in the fundamental counting action of building one-to-one correspondence between objects and names, forming a set of reciting numbers in ascending order. This could be how the first systematic conceptualisation of numbers in a set of numerals developed. Tally systems directly reflect the fundamental idea of counting for small numbers: one-to-one correspondence. Once tallying becomes an established practice, establishing a set of standard names for small numbers might be the next step, as it affords the ideas of both cardinal numbers and ordinal numbers and allows the description of a collection of objects arranged in a particular order. The analysis above indicates that counting principles could be key to the conceptual development of numeral systems. Their absence could result in counting by rote memorisation, skipping objects, counting randomly and counting an object twice or multiple times.

²The arithmetic interpretation of the Ishango bone has been recently contrasted by Keller (2016), claiming that further studies and references to archaeological finds would be needed.

5.2.3.2 Additive Systems

As counting needs for large numbers increased, the difficulty of remembering many number names led people in many societies to the idea of grouping ones, using special abbreviations for repetitions of symbols and inventing a new object or symbol to signify this quantity (Groza 1968). This grouping may be the first step in coherently combining the different records to make structural organisation common across counters (Bass 2015). It denotes the mathematical abstraction of the numeration system in which the number represented by written numerals is simply the sum of the value each numeral represents. It also requires new symbols for different groups of ones and new strategies to enumerate the new collections. The different sized groups could be the beginning of the idea of multiple units. This kind of grouping – or re-counting different cardinal collections – was developed in all ancient civilisations to count large numbers (e.g. Bass 2015). Sumerians (~3500 BCE) initially used a tally system comprised of collections of small cones to represent collections of items (Schmandt-Besserat 1992). Over time, they replaced 10 small cones with a small ball, 6 small balls (or 60 small cones) with a larger cone and 10 larger cones with a cone of the same size with a round hole in its centre, thus using a mix of bases 10 and 60. These objects were packed in a spherical clay container that had to be broken to identify the inside number. Later, these objects were represented with marks on the surface. Eventually, the objects were abandoned and only their representations were used. Using cuneiform features, marks of wedges and corners – specifically, one vertical wedge for 1 and one corner for 10 – were written on a clay tablet. Dating to around 3300 BCE, this could be the first known written additive numeral system. An updated numeration system was constructed with a set of symbols, called numerals, together with a set of rules for writing to represent numbers.

Around 1500 BCE, the Egyptians invented a hieroglyphic written additive numerical system in base ten. Around the fourteenth century BCE, the main concept used in most Chinese numerals in the oracle bone script found on tortoise shells and animal bones was grouping, which partly formed an additive system. It is interesting to note the numerals for 2 and 3, are still used in daily language. Ancient Roman numerals, such as CXXXV for 1 hundred, 3 tens and five, recorded numbers using the concept of grouping ones and regrouping into higher units. Although they used different grouping approaches at each step, many cultures (Sumerian, Babylonian, Egyptian, Greek, Roman, Arabic, Chinese, Mayan, Aztec, etc.) developed or used many-levelled additive numeral systems based on the principle of successive grouping. Thus, historically, many numeral systems were developed by progressing from tally systems to additive (grouping) systems in which multi-units with additive relations (no multiplication relations) were developed. The analysis above indicates the understanding of multi-units as necessary to deal with large numbers and of the possibility of learning difficulty in counting because of the different units and unit conversions from the tally system.

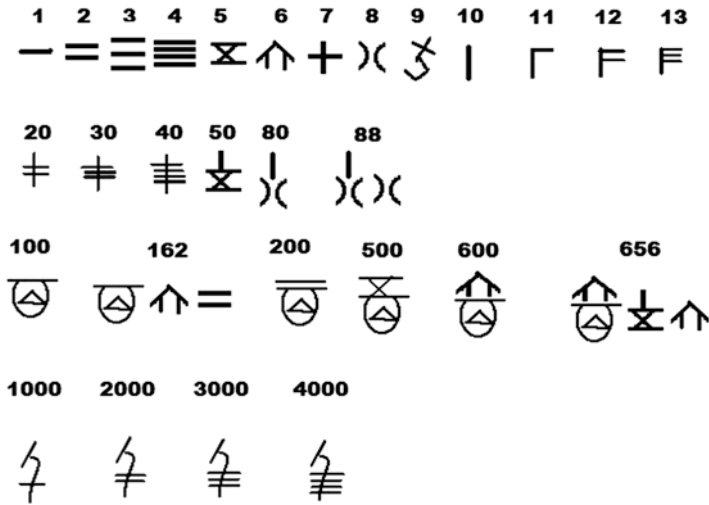

Fig. 5.1 Shang oracle bone numerals from the fourteenth century BCE

5.2.3.3 Multiplicative-Additive System

The additive systems above have been rather common inventions. Many historical examples indicate that the multiplicative concept, most often with irregular forms at the beginning, has also been a common invention for representing larger numbers with a simpler approach. Counting the signs in the additive form and then naming the value of the sign lead roughly to a multiplicative-additive system. For example, the Roman numeral CCC (300) is called *trecenti* in Latin, from *tres* (three) and *centum* (hundred). It is a numeration system in which the number value should be the sum of the products of units indicating how many of each unit are considered, where the multiplicative notion is added. Here, C is a unit rather than a number in an additive system. In such systems, there is a different symbol for each power of ten and for each number from one to the base minus one.

The ancient Chinese numeral system found on bones and tortoise shells of the late Shang dynasty in the fourteenth century BCE was the first multiplicative-additive system based on the decimal system and was both additive and multiplicative in nature. Here is a selection of Shang oracle bone numerals (Martzloff 1997; Needham 1959) (Fig. 5.1).

Here, 200 is represented by the symbol for 2 and the symbol for 100, 3000 is represented by the symbol for 3 and the symbol for 1000, etc. (Fig. 5.2). The additive nature of the system means that symbols were juxtaposed to indicate addition, so 4359 was represented by the symbol for 4000 followed by the symbol for 300, the symbol for 50 and the symbol for 9 (Fig. 5.3).

As this was not a positional system, there was no need for a zero (Fig. 5.4).

Guitel (1975) classified this as a hybrid system. A number of additive systems evolved into multiplicative-additive systems (Chinese, Mayan, etc.), but most

Fig. 5.2 Representation of 1234 on a horizontal counting board

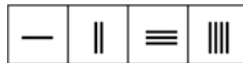

Fig. 5.3 Representation of 4359

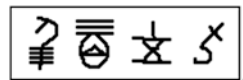
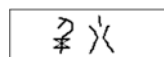

Fig. 5.4 Representation of 5080



remained additive (e.g. Roman written numerals, Egyptian, Greek). Multiplicative systems improve calculation speed. However, the difference between multiplication and addition could cause concept confusion and learning difficulty, and number naming using both multiplication and addition could present an epistemological obstacle.

5.2.3.4 Decimal Place Value System

Both the decimal numeral system and positional notation or place value notation can further simplify arithmetic operations because of the use of the same symbol for different orders of magnitude (e.g. the ‘ones place’, ‘tens place’, ‘hundreds place’). By using 1, 10 and 100 as numeration units (not number names in an additive numeral system) and both multiplicative and additive concepts, a much more advanced numeral system, the decimal place value system, was invented, in which a number can represent quantity with multiple decimal units. Both the digit itself and its referring numeration unit determine the value that a digit represents. The numeration unit that a symbol occupies determines the value of the unit, and the symbol itself determines how many of these units are being represented (Groza 1968). Using numeration units, calculations in the place value system are quite different from those in the tally and additive numeral systems. The numeration units and their conversions are the key to calculations. Addition should be carried out with two numbers with the same units, and numbers with different units should be converted to the same units using the following conversion rate: 1 thousand = 10 hundreds; 1 hundred = 10 tens (1 in the third place); 1 ten = 10 ones (1 in the second place); etc.

The Chinese counting rod system and the Hindu-Arabic numeral system are decimal place value systems (Japan, Korea and Thailand imported the Chinese decimal system (Lam and Ang 2004)). About the fourth century BCE (the West Zhou dynasty), the first place value system using counting rods came into use (Guo 2010; Martzloff 1997). Numbers were represented by small rods made from bamboo (Zou 2015) and used on a counting board (this volume, Chap. 3). A number was formed in a row with the units placed in the rightmost column, the tens in the next column to the left, the hundreds in the next column to the left, etc. (Fig. 5.4).

A zero on the counting board was simply a blank square. *Sun Zi's Suanjing* (孫子算經500 CE), the earliest extant treatise, described how to perform arithmetic operations on the counting board and gives instructions on using counting rods to multiply, divide and compute square roots. Though humans have always understood the concept of nothing or having nothing, the symbol of zero was used to represent the 'zero' first in the Hindu-Arabic numeral system. This was the first time in the world that zero was recognised as a number of its own, as both an idea and a symbol (Martzloff 1997). That place-value notation with the same ideas of zero emerging in two very different settings aimed to make more efficient systems to represent any number. Xiahou Yang's *Suanjing* (夏侯陽算經500 CE) explains not only positive powers of 10, but also decimal fractions as negative powers of 10 (Martzloff 1997), applying positional notation to the decimal fraction ring. Thus, decimal place-value notation emerged as a more efficient system for calculations of both whole numbers and fractions.

5.2.3.5 Modern Theoretical Approaches

Below, two schemes or 'theories' of place value numeral systems are proposed to describe written positional systems. The first is *classical theory*. It belongs to traditional arithmetic treatises, such as those of Bezout and Reynaud (1821) and Ryan (1827). This theory has been used in France to teach positional notation for centuries. The second theory belongs to academic mathematics.

The words for units used in numeration – that is, the words 'ones', 'tens', 'hundreds' and so on – are henceforth called *numeration units*. Numeration units are built one after the other in the following way. (1) The first ten numbers are built one after another, starting with the unit one and then adding one to the previous number, forming the numbers one, two, etc. (2) The set of ten ones forms a new order of units: the ten. (3) The tens are numbered like the ones were numbered before, from one ten to ten tens: one ten, two tens, etc. (4) Then the first nine numbers are added to the nine first tens: one ten, one ten and one one, one ten and two ones, ... two tens, two tens and one one, and so on, forming the first 99 numbers. (5) The set of ten tens forms a new order of units: the hundred and so on. Numbers' names are presented as a literal translation built on units' names (adapted from French): 'Say the tens, then the ones'. For example, as three tens is thirty and four ones is four, then three tens and four ones is thirty-four. The rules have exceptions, however. For instance, the usual name of ten-one is eleven. Finally, after building the numbers, the positional notation is stated. To write numbers without writing the units' names, it is sufficient to juxtapose the numbers of units of each order with the ones on the right side; then, each place represents a unit that is ten times larger than the one on its right. Places that are not represented are marked with the sign 0.

The current reference knowledge for place value in academic mathematics is based on the polynomial decomposition of a whole number n in a given base r : $n = \sum a_i r^i$, $0 \leq a_i < r$, which is a much more generalised expression of classic theory with the particular formal abstractions that characterise modern mathematics. The

current proof of the existence and uniqueness of the decomposition in a formal way involves Euclidian division. The positional notation is defined as the juxtaposition of the coefficients of the polynomial. This theory, which belongs to advanced algebra, is henceforth called *academic theory* (following Bezout and Reynaud 1821).

Both of the approaches presented above provide multiplicative descriptions of positional notation. The multiplicative description and the recourse to exponents are not necessary when devices for computing, such as the *suàn pán* or abacus, are used (see this volume, Sect. 9.2.2), as the device itself embodies this convention.

In sum, the decimal place value system and computation were handed down to us by our ancestors and underwent improvements over time. It is worth determining which aspects were improved and the reasons for the changes. We have described several steps, each requiring concept and relation development. From the tally system to the additive system, multiunit notions – that is, the grouping of units – are critical. Grouping units simply means a counting process using larger units, which must also rebuild the multiplicative relation with lower units. Multiplication also further simplifies the repeated addition relation, which advances the abstraction process of counting. The development of this elegant positional base-ten system took place over a long time; therefore, the fact that understanding numbers is complicated should not be surprising. Without this notation, one would encounter the same difficulties that peoples of ancient cultures encountered in large number and fraction development.

5.2.4 *Epistemological and Pedagogical Insights from History*

5.2.4.1 **Pedagogical Insights from the Pre-history of Numbers**

The pre-history of numbers and the invention of small numbers can provide insights into the beginning of the teaching of numbers and learning by young children. One-to-one correspondence is likely an essential step towards the concept of numbers: the recognition of quantity as a property of collections. History as described in the previous section(s) shows a double role of one-to-one correspondence: the intermediate collection of objects such as stones and the intermediate collection of words, e.g. the number names. As Dorier (2000) advised, history can be used to reconstruct an epistemologically controlled genesis that takes into account the specific constraints of the teaching content. The fundamental situation of numbers conceived by El Bouazzaoui (1982) and Brousseau (1997) belongs to such a programme. It has to do with quantity (not yet numbers) and can be expressed as building the same cardinal number collection to a given collection. Typically, the task is, ‘Look, there are rabbits here. Go and bring carrots so that each rabbit can eat. That is: each rabbit should have one carrot, no more, no less’. It can be observed that spontaneously, a young child does not count even if she knows a sequence of number names. From this general situation, several steps can be conceived, taking into account didactical variables (Brousseau 1997) – that is, conditions on the tasks to be achieved that can

change what children learn. For example, are paper and pencil available? If so, children can draw carrots, thus making a list of what is needed, which is an intermediate collection. How is the size of the collection – e.g. [2–6], [6–12] and [12–100] – related to children’s knowledge of the sequence of number names? Are the rabbits visible from where the carrots are? They can be drawn and arranged in specific ways, such as on a die or in several areas of a sheet of paper to foster concepts of, for example, three in one area, two in another and so on (Briand et al. 2004; Margolinas and Wozniak 2012).

5.2.4.2 Understanding Numerals’ Uses: To Write, to Compute, to Talk

Not all systems have followed the same development. For example, China never had a recorded additive system. It is interesting to note that in the West, written Roman numerals are additive, while the corresponding spoken number names are multiplicative. For example, XXX is *trīgintā* in Latin, where *tres* is 3 and *decem* is X (ten). Spoken numerals, especially for large numbers, belong to a pre-multiplicative-additive system. However, in contrast to speaking and writing, the number concept for computation is positional.

The positional principle for the Old Babylonians (ca. 2000–1600 BCE) was in base 60. Its digits are of the written additive system in base ten as they are all under 60. In the scribal school of south Mesopotamia (ca. 2000–1800 BCE), positional notation was only used for computation, never to express measurements, which used only rather small numbers, written in additive form, associated with a developed system of units (Proust 2008, 2009). The ancient Romans and medieval Europeans did not write positional numbers but used the additive system of Roman numerals even though they computed with a positional abacus, which embodies the positional principle used by the Greeks, Old Babylonians (Høyrup 2002) and Chinese (Fernandes 2015). The position of each digit within a number denotes the multiplier (power of 10) multiplied by that digit. These tools were constructed using principles similar to the abacus: a board with columns into which identical objects are put, where all of the objects in a given column indicate the same value, which is generally that of a digit of the additive system (or of the unit if it is a numeration unit system), where adjacent columns contain objects representing two successive digits (two successive units in a numeration unit system). A key feature is that if the ratio of the digits between two adjacent columns (with the lesser on the right) is n , n objects in the right column can be replaced by one object in the adjacent left column without changing the number. If the ratio between the columns is n (which would thus be the base of the system), one simply moves the objects in the adjacent left column and multiplies by n .

The case of the Incas features incompatibilities between written numbers and calculations. The Mayans and Aztecs developed a base-20 numerical system, while most of the cultures in the Andean region developed a base-ten system. The Incan civilisation used a cord system to make alphanumeric records to code information and solve numerical problems. These *quipus* are systems of strings with different

colours and knots. The position of the cords, the types of knots and the colours of the strings are elements of its logical-numerical nature (Ascher and Ascher 1981). However, the Incas used the *yupana* to make calculations using a base-ten system (González and Caraballo 2015).

When using a counting board, the successive steps of a computation in progress disappear. In the Old Babylonian case (ca. 2000–1600 BCE), as in the Chinese one, it seems that the positional notation was not used to record quantities. In the Old Babylonian tablets of Nippur (school of scribes), positional notation writing seems to have been used to indicate computational algorithms (Proust 2009) or to record the steps of a computation on a tool (Høyrup 2002; Proust 2008). In ancient Chinese books, writing with positional notation was used to explain the locations of the rods or beads on the tool and especially to explain computational algorithms (Chemla 1996; Lam and Ang 2004).

From the survey above, we come to the surprising conclusion that in many Western civilisations, to express large numbers, the written systems are additive, and the spoken systems are multiplicative, while the tools used for computations embody a positional principle. In other words, a large number written in an ‘additive’ way is often ‘spoken’ in a multiplicative way and, if used in a computation, is expressed in a ‘positional’ way using physical structure rather than written symbols. The invention and subsequent widespread adoption of the Hindu-Arabic system changed this, as this unique system is used to write and compute both positionally and multiplicative additively.

5.2.4.3 Understanding the Conceptual Changes in the Development of the Decimal Place Value System

Memorising the Multiplication Table

Ancient Egypt, ancient India and ancient Rome did not develop multiplication tables because of the additive systems they used. However, ancient China, Greece and Old Babylon did (Høyrup 2002; Menninger 1969). It is reasonable to imagine that the multiplication concept could be difficult in the current Western curriculum (Beckmann et al. 2015). In 1989, the National Council of Teachers of Mathematics (NCTM) developed new standards recommending reduced emphasis on the teaching of traditional methods relying on the rote memorisation of multiplication tables. NCTM made it clear that basic multiplication facts must be learned in the Common Core State Standards for Mathematics in the USA (Common Core State Standards Initiative, 2012). Historically, in China, the multiplication table has been a more stable part of the base-ten rod and abacus calculation curriculum, and there has been no controversy about memorising it (Cao et al. 2015). It is regarded as the foundation of multiplication/division column calculation and plays an important role in calculating rapidly and accurately (Cao et al. 2015). It includes the essential facts of column multiplication, which are similar to the function of number naming 1–9 for addition and subtraction. Therefore, the importance of memorising

the multiplication table for multiplication/division calculation curriculum development and instruction should not be underestimated.

Unit Conversions

According to the above analysis, the one-to-one relationship of adjacent unit types in the additive system needs to change to the ten-to-one relationship of the place value system. In a simple additive system, each symbol has a fixed face value. Because in the base-ten place value system, the value that a digit represents is determined by a combination of two factors, its own face value and its reference unit within a numeral, a single symbol can represent different values depending on its referent unit. By this use of numeration units, calculations in a place value system are quite different from those in tally and additive numeral systems. The numeration units and their conversions are the key to calculations: addition should be carried out with two numbers with the same units. Numbers with different units need to be converted into the same units by the conversion rate 1 thousand = 10 hundreds, 1 hundred = 10 tens (1 in the third place), 1 ten = 10 ones (1 in the second place). Therefore, the composition and decomposition of a higher unit is a key procedure for addition/subtraction that cannot be realised by the counting approach in tally and additive numeral systems. Thanheiser (2015) designed an intervention based on a history of numeration with successive steps – tally, additive and positional base-ten systems – and then performing computations with these systems to reinforce place value for teacher education. Thanheiser argued that the unit conversions can be difficult because they do not develop naturally in calculations in the additive system: counting on, counting down and the doubles approach.

5.3 Foundational Ideas from Language and Culture

Number language is the first cultural symbol a human encounters in mathematics, and it appears more salient than other teaching and learning factors in relation to WNA. The notions of numbers are first learned as a linguistic routine of counting through which the number names are perceived as sign systems or cultural semiotic systems that enable the symbolic representation of knowledge (Goswami 2008). There are few studies on conflicts among number naming, cultural identities and universal decimal features and how local languages are linked to universal Hindu-Arabic numerals. In the following, these two questions are discussed.

5.3.1 *Whole Number Naming: Universal vs Cultural*

A clear example of such conflict is in whole number naming, where history and culture shape not only number names and conceptualisations but also their use in measurement and operations. When analysing this phenomenon, two situations emerge: the first one is what remains from ancient times, which contaminates a more recent and coherently organised cultural system at the oral level, such as the case of spoken numbers in Denmark. The second situation relates to the lively colonial process related to different uses of language fed by political and social interactions that continuously develop over the years, such as spoken and written numerals in post-colonial areas such as Algeria and Guatemala. Analysis of the two situations is possible thanks to direct reports in the working group and provides interesting insights into the historical evolution of elementary arithmetic and how it can affect number names and result in learning difficulties. Importantly, both situations may offer opportunities to enhance the learning and teaching of numbers and contribute to the awareness of a cultural identity if sensitively handled by teachers.

5.3.1.1 **The Danish Case: The History of Number Names in Denmark**

As presented by Ejersbo and Misfeldt (2015), in a typical situation, the effects of the past on spoken number names in Denmark have led to problems for many children. Some number labels are rooted in ancient names, reflecting a primitive non-decimal system. One hundred years ago, ‘eighty’ was said as ‘four times twenty’, but in daily speech, it became ‘firs’, which is close to ‘fire’ or ‘four’ in Danish. About 50 years ago, this abbreviation was made official, as ‘times twenty’ was dropped for counting numbers, although it was retained for ordinal numbers. ‘Seventy’ in Danish is said as ‘half four’ and previously as ‘half four times twenty’. ‘Half four’ is actually a half taken to four (from three), so it means ‘three and a half’ (as in German time counting, where ‘half four’ means ‘half past three’). Thus, as Danish practices inversion for spoken numbers between 13 and 99, ‘seventy-three’ is said literally as ‘three and half-four’. As the old roots are unknown to most students, the names of the tens up to 100 are taught through rote learning, and the underlying rules are not addressed. This has caused difficulties for Danish students, many of whom are insecure about reading and writing two-digit numbers for their first 3 or 4 years of schooling (Ejersbo and Misfeldt 2015).

Thirty years ago, it was common practice to address these difficulties at a cultural level by offering opportunities both for teachers and for children to reflect on the roots of the mathematical notion. Examples were used at cognitive and pedagogical levels to highlight relevant features, such as the present decimal positional system (base 10 in comparison with base 20) and the additive nature of representation in a given base. Today, these opportunities are not exploited in the first years of school, as there was little evidence to support the learning of the number names (possibly due to how the teaching had been organised). Danish students continue to

struggle with combining the words for a number, its cardinal value and its digit representation. Thus, while, a language changes according to how it is spoken in everyday life, it seems difficult to change number names because of cultural continuums, even though doing so would help students better understand numbers.

5.3.1.2 The Algerian Case: Language Diversity in the Post-colonial Era

Many previously colonised countries retain the influences of their old political masters, which are often reflected in their educational systems, such as in the organisation of schools, the content of the curriculum and the languages in which specific subjects are taught. Young children learn to count in their native language, and this is encouraged until they begin formal schooling. Thus, in their early years, when teachers seek to develop a strong number sense, they can find it challenging to learn WNA in a ‘foreign’ language. Unfamiliar words and new conceptualisations often lead to identity problems for children.

Azrou (2015) studied the situation in Algeria. Over the last 50 years, as the power and cultural relationship between France and Algeria changed, a range of decisions were made by the authorities regarding the teaching of mathematics at different levels. For example, at the university level, all mathematics is taught in French, but at the school level, while formulae are written in the Latin alphabet and read left to right, mathematical terms are written and spoken in Arabic (right to left). The difficulties young children experience are exemplified in the Algerian context. Four languages are spoken (classical Arabic, dialect, Berber and French), and oral and written words are shared differently by different social groups. For example, although numbers are taught in classical Arabic in schools, some children from particular communities speak only a dialect and/or Berber. At this stage of schooling, because of inversion, children are expected to write numbers from the lowest-value digit to the highest – that is, from right to left like word writing. This expectation changes at grade three, at which point all children are expected to engage with numbers not only in Arabic but also in French, where words are written from left to right and where there is no inversion above 16. Some children write numbers from the lowest to the highest-value digits in the direction of word writing for both languages.

The analysis of these two situations provides some insight into the language evolution of elementary arithmetic and how it can affect number naming and result in learning difficulties. Obviously, whole number language conflicts between universal, cultural and colonial naming can cause meta-level learning difficulty. Therefore, a bridge between curriculum and instruction is needed to link local languages to universal Hindu-Arabic numerals.

5.3.2 *The Incompatibilities Between Spoken Numbers, Written Numbers and Numeration Units Within 100*

When Anglophone speakers learn how to tell quantities and then write (in digits) ‘what they hear’, they are faced with the difficulties of two changes in the number structure: 11 and 12 sit outside the ‘teen’ numbers, 13–19, where an inversion structure in the spoken names (the ones-place digit, not the tens-place digit, is spoken first) is used (thirteen, fourteen, fifteen, sixteen, seventeen, eighteen and nineteen). There seems to be no logic to this disturbance to what is otherwise a strong pattern in English’s number system in English. Thus, these words have to be learned and remembered. In contrast, the Chinese system provides a logical way of reading: 11, 12 and the ‘teen’ numbers (ten-one, ten-two, ten-three, ten-four, ten-five, ten-six, ten-seven, etc.) do not need learning or remembering in quite the same way. Another difficulty is the inversion structure (as demonstrated in the Algerian and Danish cases above) between spoken numbers (e.g. the ones are said before the tens in 14) and written numbers (e.g. the tens are written before the ones in 14), which could cause learning difficulties. The cognitive challenges of the number learning of 11–19 have long been recognised as ‘the trouble with teens’ (Miller and Zhu 1991). This might relate to the controversial question of place value or quantity value in the Western curriculum (e.g. at what stage should the 3 in 38 be identified as 3 tens rather than 30 (Askew and Brown 2001)?).

Houdement and Tempier (2015) identified three number systems in the process of knowing numbers: written numbers (written as 56, showing face value), spoken numbers (spoken as fifty-six, showing quantity value, number size made of ones) and numeration unit numbers (presented as 5 tens and 6 ones, showing place value, number size made of numeration units). Generally, a spoken number system is rooted in local oral language, and it naturally follows the grammar of local language and thus directly shows cultural identity. It is often irregular in Western languages (72 = *soixante-douze* in French, i.e. sixty-twelve). It is mainly learned at home as an inherited mother language. The spoken names are developed as sounds connected to the numbers of objects in the sets. Written numbers are mainly learned at school as a second language. Teaching the third system (the numeration unit numbers, showing place value) specifically and gradually in relation to the two others might facilitate understanding of (1) the base-ten place value system (Tempier 2013), (2) computation algorithms (Ma 1999) and (3) the decimal form of rational numbers. In English, numbers’ names are those of the units, but not in French. In France, the names of the second, third and fourth decimal numeration units for whole numbers are not used in the everyday language (Chambris 2015).

In many languages of East Asia and elsewhere throughout the world (such as several African languages), spoken numbers are similar to numeration unit numbers. Written numbers are numeration unit numbers without the numeration units, so the relationships among them are simpler than the European ones. In the Hindu-European language area, students must memorise many spoken, written and numeration unit names without connecting them logically with the written names (‘ten’ is

not heard between 11 and 16). A way to achieve a logical link is to translate written names into numeration unit names and vice versa. This is related to the role of numeration units in the curriculum in many countries. For example, in America, Fuson, Smith and Lo Cicero (1997) explored ‘tens’ and ‘ones’ in English (and ‘decenas’ and ‘unidades’ in Spanish), but did not refer to ‘units’ but to ‘tens-and-ones words’ and also to ‘position’ in Spanish. In French textbooks, numeration unit names – e.g. ones, tens and hundreds – disappeared from the curriculum in the 1970s; they may remain as place names. It is frequent not to find the relation 1 hundred = 10 tens in current French second and third grade textbooks (Chambris 2015). Tempier (2013) observed three third grade teachers and found that only one of them explicitly referred to the relations among units, although all three used the units’ names to describe places. Numeration units completely disappeared as units in the 1980s, but they remained as places (position) and may have reappeared in other forms and practices since 1995.

5.3.3 Links and Incompatibilities Between Numeration and Calculation

It seems that hundreds and thousands play a more visible role in spoken Western languages than ones and tens because the latter do not function as units in many spoken languages within 100. Thus, an opportunity to build an understanding of the numeration structure is lost. As mentioned above, the Chinese language stresses that spoken numeration recalls both the number name and numeration unit based on the language categories of classifiers (Sun 2015), which specifies the value of digits in a clearer way. The corresponding teaching and learning of numbers and calculations emphasises how to compose/decompose a numeration unit by using a composition or decomposition approach (e.g. 1 ten = 10 ones). Compared with many Western curricula, counting and memorising number facts is emphasised, especially in the teaching and learning of 1–2 digit calculations. In Chinese, the result of $8 + 7$ is said as ten-five. The number name fosters the use of the make-a-ten method: eight plus two, ten plus five as the result is given in the procedure. In the same manner, to compute $40 + 10$, one has to say that four tens and (one) ten is five tens. If the language does not stress the unit of tens, children will obtain various answers. For example, in French, $8 + 7$ may be $7 + 7$ (double) fourteen and one. Young children memorise ‘doubles’ rather quickly, and then there is only one (easy) step left to find 15. To make a ten to compute $8 + 7$ requires the following: (1) to make ten with 8 (take 2), (2) take 2 from 7 (5 left) and (3) transform 10 and 5 into 15. This last step does not exist in Chinese, but it does exist in languages that do not use ten to compose the names of numbers between 11 and 19. In many European languages, the cognitive cost of counting addition up to 20 with doubles (with additional counting up to 3) is probably often less than that of using the make-a-ten method. For example, Portuguese textbooks suggest ‘doubles’, ‘doubles plus 1’, ‘compensation’ (e.g.

$6 + 8 = 7 + 7 = 14$) and ‘reference numbers’ ($6 + 7 = 5 + 1 + 5 + 2 = 10 + 3 = 13$) in addition calculation and ‘counting back’, ‘the use of tables for the addition to subtraction’ and ‘identifying inverse operation of subtraction as addition’ in the subtraction calculation (Sun et al. 2013). In contrast to the Chinese curriculum, the make-a-ten method, a core concept of addition and subtraction within 20, is often regarded as the foundation of the place value of tens (Sun 2015). It lays the foundations for multi-digit calculation by maintaining coherence between two-digit and multiple-digit addition/subtraction, which may not be the case in most Western curricula because the tens in a teen number name do not play the role of the tens place but are a quantity value role (e.g. $10 + 3$ is said as thirteen). Most European languages break away from clear regularity in respect to the base-ten place value system, especially with the numbers from 11 to 19 and 19 to 99 (Ejersbo and Misfeldt 2015). Fuson et al. (1997) found that English-speaking children perform badly with the make-a-ten method but suggested that material showing tens in teen numbers might be fruitful.

The Chinese curriculum uses the make-ten method in the first grade to develop the concept of place value and generally assigns at least 30 hr (1/2 time of the first term) for the conceptual foundation of addition/subtraction, with regrouping as its core practice. Specifically, the make-ten method has been designed critically for the composition of a tens unit, which is also an important aspect of the concept of place value (Ma 1999) and in understanding the concept of addition with regrouping inherited from the principle of the bead calculation tradition (Sun 2015). Ruthven (1998), like many Western scholars, argued that close scrutiny of the mental calculation strategies used by children for the four basic operations suggests that there is no evidence of what is normally understood by place value in their methods. Thompson (1999) claims that mental calculation strategies utilise what has been described as the quantity value aspect of place value (56 seen as 50 and 6), whereas standard written calculations necessitate an understanding of the column value aspect (56 seen as 5 tens and 6 ones). This subtle but important difference has implications for teaching, as it could provide a possible reason why Chinese teachers demonstrate greater conceptual understanding of subtraction in regrouping when decomposing a higher value unit compared with their American counterparts (Ma 1999).

5.3.4 How to Bridge the Incompatibility: Some Interventions

Because of the numerous difficulties in number names in many languages, interventions for bridging the incompatibilities between spoken numbers, written numbers and numeration unit numbers are critical. Numeration unit number language in many Eastern countries uses place notion, which is fundamental to the computation. What kinds of didactical language inventions can we use for WNA to better support the conceptual development of numbers and computations?

Several kinds of intervention on this issue were reported at the Macao conference:

1. Ejersbo and Misfeldt (2015) introduced a didactical linguistic invention: regular number names. These more ‘logical’ number names are formed with the names of the powers of ten, which are those of units in Danish, like in Chinese. This enhanced the acknowledgement of number structure/regularity and improved the rote learning of number names and computation. A similar invention (Fuson et al. 1997) ‘allowed all children to enter the conversation about place-value meanings and 2-digit addition with regrouping before some of them had fully mastered the English number word sequence to 100’ (Fuson 2009, p. 346).
2. Sun (2015) introduced a Chinese approach to enhance reasoning by connecting the three core concepts of addition, subtraction and numbers together in the Chinese curriculum. This approach is used in all chapters of addition and subtraction. a. Adding one to a number obtains its adjacent number. b. Subtracting one from the adjacent number gives the original number. By this approach, not only are the three concepts of addition, subtraction and number tied closely together, but connections are formed between them, and the concepts of inverse and equation are developed. This promotes not only doing and memorising but also reasoning. In contrast, in some Western curricula, the ideas of numbers, addition and subtraction are presented in three separate chapters, isolated from one another. This might influence mathematics learning attitudes at the beginning.
3. Considering the French curriculum, Houdement and Tempier (2015) proposed a complete system with a focus on numeration units with which all numbers – whole and decimal fractions – can be linked. Among other tasks, they introduced various ways of quantity counting, including one by one and ten by ten in tens.
4. Awareness of the teacher education curricula situation is poor. Azrou (2015) presented the initial step of an intervention project to use difficulties as educational resources. For example, by comparing the French wording of numbers between 11 and 16 with their Arabic or Berber counterparts, students may better realise the anomalous nature of French spoken numbers. By analysing their structure between 60 and 100 in base 20, they may engage in stimulating conversion exercises. From a teaching perspective, developing a clear understanding of these patterns of learning numbers and acknowledging their different characteristics would facilitate effective and meaningful communication between teachers and students and might thus help teachers deal with diversity in the classroom and more effectively scaffold children’s learning.

Finally, Sayers and Andrews (2015) developed a simple, eight-dimensional framework through a systematic review of the literature on number sense. Teachers in the Anglophone world often refer to the importance of developing a strong number sense of WNA in elementary school to prepare learners for the adult world (McIntosh et al. 1992). However, psychologists consider number sense innate in all humans (Ivrendi 2011), indicating a gap between what a human is born with and what needs to be taught in elementary school. Sayers and Andrews (2015) developed and tested a new theoretical framework that bridges this spectrum, which they call founda-

tional number sense, identifying key whole number concepts that require instruction during the first year of schooling.

In short, the foundational ideas that stem from languages and cultures indicate that local number naming can be used to build cultural identities. However, it also causes conflicts between local languages and universal Hindu-Arabic numerals, leading to learning difficulty. Therefore, curriculum and instruction must be bridged to link local languages to universal Hindu-Arabic numerals and calculations. The bridges between the incompatibilities of spoken numbers, written numbers and numeration unit numbers are critical to solutions. In particular, linking numeration unit numbers with spoken numbers, written numbers and the make-a-ten method within 100 may be fundamental for such interventions.

5.4 Foundational Ideas Influenced by Multiple Communities

In the previous sections, we provided insights into WNA from both historical and language perspectives. We highlighted how WNA developed from ancient times and how traditional cultural roots can influence and perhaps conflict with the process of learning and teaching mathematics today. According to Morrish (2013), contemporary education must actively seek change for rapid development of the economy, science and technology once they lose their advantage. Attempts at change, often triggered by international comparative studies of mathematics achievement, have had diverse reactions and consequences (Feniger et al. 2012). Such changes by policy makers and educators are interpreted and negotiated through a series of processes framed by a variety of principles and practices (Kanes et al. 2014; Leung 2014; Wiseman 2013).

Mathematics education is embedded in the four major contexts of economics and business, academic mathematics, science and technology and public and private stakeholders, and their influence should not be neglected. In the following, we focus on how the teaching and conceptualisation of WNA have been changed by academic mathematics, science and technology, and the public and stakeholders. The first case concerns the influence of economic and business and ancient China. The other cases concern the influence of academic mathematics, science and technology and public and private stakeholders in modern times in Israel, France and Canada, respectively. These cases seek to understand the how and why of curriculum changes, with a focus on the fundamental losses and gains. The choice of examples is related to reports made by participants at the Macao Conference.

5.4.1 The Influence of Economics and Business: A Case from Ancient China

Sun (2015) discusses how the early Chinese invented number names and calculation tools (counting rods and, later, the *suàn pán* or Chinese abacus), in which place value is the overarching principle that captures the spirit of WNA (Lam and Ang 2004). This advanced the development of Chinese mathematics. However, rod calculation speed is slow and inconvenient for calculation with large numbers, which is often necessary to calculate labour, capital and products in the markets. To meet the need for efficiency for economics and business development, the Chinese abacus replaced the ancient counting rods, improving calculation speed and efficacy (Sun 2015). The replacement of rods caused a significant deterioration in calculation rationale from the time of rod calculation (Lam and Ang 2004), because the step-by-step procedures using rods were replaced by the ‘calculation songs’ of bead calculation.

In *Tongwen Suanzhi* (同文算指 literally meaning ‘rules of arithmetic common to cultures’), compiled by the official scholar Li Zhi-zao (李之藻 1565–1630) of the Ming court in collaboration with the Italian Jesuit Matteo Ricci (利瑪竇 1552–1610), written calculation that had been in common practice in Europe since the sixteenth century was introduced into the Chinese system. Compared with the methods of traditional bead calculations, the main advantage of written calculation lies in keeping a record of the intermediate steps, enabling easy checking afterwards. It also allows viewing of the procedure, facilitating the understanding of the underlying reasoning without having to memorise what is going on during the calculation. This is difficult to attain in calculation using counting rods or an abacus. Siu (2015) argued that the rationale for learning written calculation, at least once in a person’s lifetime, seems to be the acquisition of understanding of the underlying principle of the basic operations in arithmetic, which is essential in future learning. He further warned that using electronic calculators in current primary schools is similar to bead calculation, where the intermediate calculation rationale is hidden. ‘Ironically we would be turning back the wheel of history in some sense in that we erase the intermediate steps if we depend on an electronic calculator too much’ (p. 137). To meet the growing need for a quick analytical and quantitative approach to problem solving, changes in calculation tools were needed. However, the associated calculation rationale was becoming weaker and thus needed to be addressed.

5.4.2 The Influence of Academic Mathematics: A Case from the Mathematics Community in Israel

Considering the depth of their mathematical understanding, it is natural to assume that mathematicians should have a role in the professional development of elementary school teachers. However, mathematicians have little experience of teaching

WNA. Furthermore, the discourse of university mathematics and its teaching is quite different from its elementary school counterpart. What might happen if members of these communities were to meet and interact? This question was investigated in a professional development (PD) course for in-service elementary school teachers in Israel that was conceived and taught by a professor of mathematics.

Cooper (2015) analysed mathematical and pedagogical discourse as related to a particular mathematical topic – division with remainder (DWR). In school mathematics, DWR is transient: it becomes redundant once students are familiar with the field of rational numbers. In advanced mathematics, DWR is generalised to Euclidian domains. Remainders of DWR are also important as representatives of the ring $\mathbb{Z}/n\mathbb{Z}$. In view of such differences, Cooper asks, how can the meeting of a mathematician and in-service elementary school teachers foster mutual professional growth?

The instructor (Rick) was struck by the problematic aspect of standard notation. The = sign denotes equality, which should be transitive. If we write $25:3 = 8(1)$ and $41:5 = 8(1)$, transitivity of equality demands that $25:3 = 41:5$, which Rick considered ‘complete nonsense’. His proposed solution was to change the notation:

Standard notation in Israel: $25:3 = 8(1)$. Proposed notation: $25:3 = 8(1:3)$

The new notation is read ‘eight with remainder 1 which needs to be divided by 3’. To justify the new notation, Rick claimed that $8(1)$ has no meaning as a quantity when the divisor is not known. However, some teachers challenged this, claiming that the 8 and the 1 are ‘quantities’ and that the equality $25:3 = 41:5$ is an equivalence. Indeed, there is nothing intrinsically wrong with this equivalence relationship, where $8(1)$ represents a class of DWR exercises that have the same result (quotient and remainder). Thus, the equality is ‘complete nonsense’ only because it is not consistent with the mathematical horizon of fractions, where $\frac{25}{3} = \frac{41}{5}$ is indeed incorrect. Although they did not agree with Rick regarding the standard notation’s deficiencies, the teachers did endorse the new notation for its pedagogical affordance in providing a smooth transition from whole numbers to fractions. Rick emphasised this affordance in presenting the remainder as having the *potential* to be divided, a potential that can be realised in fair sharing situations in which the unit can be split and will be mathematically realised in fraction arithmetic. Pedagogical affordances were further explored. One teacher attending to procedures at the pedagogical horizon appreciated how the new notation might offer a smooth transition to decimal long division, where students often neglect to divide the remainder. She felt that the new notation, in signalling an unfinished division, would help overcome this difficulty. This episode, one of many described by Cooper (2015), shows how two communities with conflicting perspectives on DWR and its notation jointly explored the mathematical and pedagogical aspects of mathematical notation and worked together to gain a deeper understanding of this surprisingly complex topic, gaining insight that was new to all parties involved. In this way, the community of academic

mathematics contributed to the professional development of elementary school teachers while at the same time deepening their own understanding of school mathematics and its teaching.

5.4.3 *The Influence of Science and Technology: A Case from the New Math Reform in France*

Science and technology also affect WNA. After the Sputnik crisis, to boost science education, technological development and mathematical skill in the population, New Math was introduced in many countries. Chambris (2015) reported on the New Math reform in France. This international phenomenon (ICMI 2008; Kilpatrick 2012) affected all levels of mathematics teaching in the 1960s and the early 1970s and has had lingering effects. It had two major focuses: (1) teaching ‘new’ math, including renewing of the mathematical fundamentals of teaching (e.g. Griesel 2007) and (2) taking into account psychological features related to learning and child development. Two famous subjects were introduced in WNA: set theory, an aspect of contemporary math, and numeration bases other than ten (hereafter called bases) (to teach base-ten principles), an aspect of psychology (Kilpatrick 2012; Bruner 1966). This phenomenon may be interpreted in terms of the construct of *didactical transposition* (Chevallard 1985) – the transformation and adaptation of knowledge produced by the scientific community to make it suitable for use as learning objects. This transformation occurred at the end of the 1970s.

In France, from 1900 to 1960, the classical theory (history section above) was adapted in close terms in textbooks. Tasks such as ‘Write in figures: 3 H 4 T 5 O’ and ‘convert 3 hundreds into tens’ – both using the symbolic register of the numeration units – were basic and current. They disappeared as the ‘bases’ appeared. Students interpreted the positional notation in ‘bases’ as a procedure, grouping and ungrouping, and they struggled when they had no manipulatives left (ERMEL 1978; Perret 1985). The process is as follows: $\sum r_i a^i$ becomes $\sum r_i 10^i$; then, $a \times 1000 + b \times 100 + c \times 10 + d$ or $a000 + b00 + c0 + d$. Such ‘writings’ as $40 + 7 + 50 + 43 + 25$ also appeared. ‘The key issue is to familiarise children with a direct work with the writings’ (our translation; ERMEL 1978, p. 17): 1, 10, 100, 1000, etc. played an increasing role. Within a few years, ‘write in figures: 3 H 4 T 5 O’ was replaced by ‘compute $3 \times 100 + 4 \times 10 + 5$ ’ or ‘compute $300 + 40 + 5$ ’. Conversions were not replaced. A new symbolic register – that of the powers of ten written in figures – had emerged, and the number 1 became the only unit to be taught.

Within the transposed academic theory, the technique to obtain positional notation from $3 \times 100 + 4 \times 10 + 5 \times 1$ is to ‘juxtapose 3, 4, 5’. The present implicit rules to obtain it are to (1) multiply by 100 (resp. 10) (write two (resp. one) zeroes on the right) and (2) add numbers (use a ‘column algorithm’). That is, put them one under the other, aligned from the right side. In 1995, decompositions with numeration units began to come back. The way to achieve them is $3 \text{ H} = 300$ (due to the hun-

dreds place), $4 T = 40$, $5 O = 5$; then, compute $300 + 40 + 5$, that is, 345. Thus, in the contemporary period, there is a kind of hybridisation by the units of the transposed academic theory. However, numeration units indicate only the digits' places and their units, and it is common not to find the relation 1 hundred = 10 tens in present second and third grade textbooks. This provides three interpretations of positional notation: it sums up an additive relation in the latter case, the numbers of units in the classical theory, and serves as a polynomial algebraic relation within the transposed academic theory.

The influence of academic mathematics is apparent within the use of the academic theory. As in the previous case, two kinds of tension between school and academic mathematics arise: (1) different needs (units vs advanced algebra) and (2) different perspectives on a shared sign symbolism (positional notation).

5.4.4 The Influence of Public and Private Stakeholders: A Case from Current Curriculum Reform in Canada

Public and private stakeholders also affect WNA. The implementation of international achievement tests such as TIMSS in 1995 and OECD's PISA in 2000 prompted widespread curriculum reform, which often focused extensively on WNA. Multiple stakeholders, including educators, school personnel, business leaders and parents, often expressed conflicting arithmetic goals and pedagogical expectations (Brown and Clarke 2013). These conflicts, called the 'Math Wars', occurred in North America (e.g. Klein 2007), Europe (e.g. Prenzel et al. 2015) and China (Zhao 2005).

Although Canada performs well in international tests, the public and private stakeholders of current curricula have sparked public debate. For example, students are expected to develop flexible and mental mathematics strategies through the use of compensation methods (e.g. $54 - 37 = 54 - 40 + 3$) and properties of numbers and operations (e.g. $8 \times 6 = 8 \times 3 \times 2$) to compute. Through an analysis of online responses to newspaper articles reporting Canada's faltering PISA scores, McGarvey and McFeetors (2015) sought to understand public perspectives. The following quotation is an example of an online comment posted in response to a national news article written by mathematician opposing today's elementary curriculum:

I learned things by rote in grade school and then later on in high school I learned how to do abstract problem solving in topics like algebra. From what I understand, the system is unnecessarily complicating kids' minds by saying they shouldn't memorize basic multiplication or learn how to do long division or carry numbers. I don't see the usefulness in that. (McDonald 2013)

Keywords in this comment such as 'by rote', 'memorise', 'long division' and 'carry' tend to trigger negative reactions from mathematics educators in much the same way that 'mathematics for understanding', 'strategy-based learning' and 'student-centred approaches' often trigger negative reactions from the public.

Rather than dichotomising the arguments, the analysis revealed two sets of shared goals: (1) students need the opportunity to reach expected mathematics goals (e.g. develop computational skills and problem-solving), and (2) essential supports must be in place for students to reach the goals of mathematics learning (e.g. knowledgeable teachers, clearly written teaching resources). Reframing criticism into mutual concerns offers a starting place for conversation that empowers communities to see commonalities in their perspectives of children's mathematics learning. In short, public and private stakeholders in Canada and in other countries have affected WNA by changing policies and goals.

5.4.5 Foundational Ideas Summary: Understanding the Unpredictable Long-Term Effects of Change

The four reports above describe the influence of economics and business, academic mathematics, science and technology, the public and stakeholders and the various changes in the conception of WNA and its teaching. For example, in the wake of New Math, the incorporation of academic mathematics as foundational knowledge into school mathematics may lead to fundamental loss of various elements, including numeration units. In contrast, Cooper's example demonstrates how the mathematicians' perspective must undergo didactic transposition to fit the teaching and learning of WNA. Thus, to foster change, school mathematics and academic mathematics should be combined. The professional development described by Cooper can be seen as an important step in the enactment of such a transposition. However, taking the mathematicians' perspective into account in WNA curriculum design is a complex matter. While these examples may not be applicable outside their specific contexts, they may lead us to reflect upon ways in which new goals for WNA might be defined and implemented. However, a number of themes emerge when considering the four cases as a whole related to issues that are likely to arise when defining, implementing and communicating new goals for WNA.

Deep changes seem to occur slowly, perhaps because some features of prior practices persist, but once change has begun, it seems impossible to stop. This is evident in the lingering effects of New Math long after its apparent failure. The arguments used to introduce bases in the New Math curriculum came from psychology. Yet after the turbulent period of reform, during the so-called counter-reform, the "new" mathematics – here represented by an academic theory that is, in fact, not so new – became a mathematical foundation for the teaching of place value. The effects of the changes were probably neither anticipated nor mastered. This also seems to be the case in the changes in China, especially the replacement of rods with beads. When change is implemented, awareness by educators and policy makers is needed because where there are gains, there can also be fundamental losses to elements once taken for granted. This is important because key aspects of a complex

system may be almost invisible to observers and may be lost when changes are made.

New Math was partly directed by economic issues linked with the growing needs of engineers and scientists in Western societies. PISA studies from the Organisation for Economic Co-operation and Development aim to determine the extent to which 15-year-old students are prepared to face the demands of the society they will live in. Does society need globalised mathematics education and, if so, how will it manifest itself in the future? Are the PISA tests the *Tongwen Suanzhi* (above) of modern times? Where will the changes develop in relation to the economic needs of society (Siu 2015)? One might suppose that history repeats itself in the redesigning of a WNA curriculum, as it must take into account the evolution of economic societal needs, thus causing tensions such as those described above.

In the examples described above, one or more of the operating communities engaged in a genuine attempt to understand the other's perspective and to promote productive communication. Despite decades of efforts to explain the benefits of current approaches in whole number arithmetic, the arguments have not been convincing for many stakeholders. Seeking ways to identify common goals and to address unfamiliarity with current approaches is an essential step in re-engaging parents and the community in children's learning. A certain failure of New Math reform is acknowledged (Kilpatrick 2012), despite some cooperation between mathematicians, psychologists, math educators and teachers. A lack of teacher education, a lack of resources and incompatibility between academic math and school math are often cited as reasons for this failure. Finally, recurring themes arise as means to achieve changes: bridging communities to share goals and means between stakeholders and the adaptation of teacher education and resources to the new goals.

5.5 The What and Why of WNA: Towards a Cognitive Dimension

The historical, cultural and linguistic foundations of WNA set out in this chapter have influenced how an educational system develops its WNA. How students develop fundamental ideas about WNA and what is needed by teachers to nurture such ideas remain themes in the following chapters. However, several papers in this group have examined some of the different representations of how teachers might present WNA at different stages of children's development. The discussions in these papers have provided important insights into the processes that can be evoked in different communities from different perspectives. Other influential aspects, such as humans' innate cognitive abilities, are detailed in Chap. 7, while language, artefacts and tasks used by teachers are instantiated in Chap. 9. The delicate question of teacher education is addressed in Chap. 17.

References

- Ascher, M., & Ascher, R. (1981). Ethnomathematics. In A. B. Powell & M. Frankenstein (Eds.), *Ethnomathematics: Challenging Eurocentrism in mathematics* (pp. 25–50). Albany: State University of New York Press/SUNY Press.
- Asker, M., & Brown, M. (2001). *Teaching and learning primary numeracy: Policy, practice and effectiveness*. Nottingham: British Educational Research Association.
- Barton, B. (2008). *The language of mathematics: Telling mathematical tales*. New York/Berlin: Springer.
- Baxter, W. T. (1989). Early accounting: The tally and checkerboard. *Accounting Historians Journal*, 16(2), 43–83.
- Bezout, E., & Reynaud, A.-A.-L. (1821) *Traité d'arithmétique à l'usage de la marine et de l'artillerie, 9e édition*.
- Briand, J., Loubet, M., & Salin, M.-H. (2004). *Apprentissages mathématiques en maternelle*. Paris: Hatier.
- Brousseau, G. (1997). *The theory of didactical situations in mathematics (Didactique des mathématiques, 1970–1990)* (N. Balacheff, M. Cooper, R. Sutherland, & V. Warfield, Eds. and Trans.). Dordrecht: Kluwer Academic Publishers.
- Brown, T., & Clarke, D. (2013). Institutional contexts for research in mathematics education. In M. A. Clements, A. J. Bishop, C. Keitel, J. Kilpatrick, & F. K. S. Leung (Eds.), *Third international handbook of mathematics education* (pp. 459–484). New York: Springer.
- Bruner, J. S. (1966). *Toward a theory of instruction*. Cambridge, MA: Harvard University Press.
- Cauty, A. (1984). Taxinomie, syntaxe et économie des numérations parlées. *Amerindia*, 9, 111–146.
- Chemla, K. (1996). Positions et changements en mathématiques à partir de textes chinois des dynasties Han à Song-Yuan. Quelques remarques. *Extrême-Orient, Extrême-Occident*, 18, 115–147.
- Chemla, K. (1998). History of mathematics in China: A factor in world history and a source for new questions. *Documenta Mathematica, extra volume ICM 1998, III*, 789–798.
- Chemla, K. (2007). Observing mathematical practices as a key to mining our sources and conducting conceptual history: Division in ancient China as a case study. In L. Soler et al. (Eds.), *Science after the practice turn in the philosophy, history, and social studies of science* (Vol. 14, pp. 238–276). London: Routledge.
- Chevallard, Y. (1985). *La transposition didactique*. Grenoble: La Pensée sauvage.
- Crump, T. (1990). *The anthropology of numbers*. Cambridge: University Press.
- Dorier, J.-L. (2000). Use of history in a research work on the teaching of linear algebra. In V. Katz (Ed.), *Using history to teach mathematics – An international perspective, MAA notes* (Vol. 51, pp. 99–110). Washington, DC: The Mathematical Association of America.
- El Bouazzaoui, H. (1982). *Étude de situations scolaires des premiers enseignements du nombre et de la numération. Relations entre divers caractères de ses situations et le sens, la compréhension de l'apprentissage de ces notions*. Doctoral dissertation. Bordeaux: Université de Bordeaux 1.
- ERMEL. (1978). *Apprentissages mathématiques à l'école élémentaire. Cycle élémentaire. Tome 2*. Paris: SERMAP-Hatier.
- Feniger, Y., Livneh, I., & Yogev, A. (2012). Globalisation and the politics of international tests: The case of Israel. *Comparative Education*, 48(3), 323–335.
- Fernandes, L. (2015, January 11). *The Abacus: A brief history* [Blog post]. Retrieved from <http://www.ee.ryerson.ca/~elf/abacus/history.html>
- Fuson, K. C. (2009). Avoiding misinterpretations of Piaget and Vygotsky: Mathematical teaching without learning, learning without teaching, or helpful learning-path teaching? *Cognitive Development*, 24(4), 343–361.
- Fuson, K. C., Smith, S. T., & Lo Cicero, A. (1997). Supporting Latino first graders' ten-structured thinking in urban classrooms. *Journal for Research in Mathematics Education*, 28(6), 738–766.

- Goswami, U. (2008). *Cognitive development. The learning brain*. Hove/New York: Psychology Press.
- Griesel, H. (2007). Reform of the construction of the number system with reference to Gottlob Frege. *ZDM: Mathematics Education*, 39(1–2), 31–38.
- Groza, V. S. (1968). *A survey of mathematics: Elementary concepts and their historical development*. New York: Holt, Rinehart and Winston.
- Guitel, G. (1975). *Histoire comparée des numérations écrites*. Paris: Flammarion.
- Guo, S. (2010). *Chinese history of science and technology*. Beijing: Science Press. [In Chinese].
- Høyrup, J. (2002). A note on old Babylonian computational techniques. *Historia Mathematica*, 29(2), 193–198.
- ICMI. (2008). *The first century of the International Commission on Mathematical Instruction. History of ICMI* by Furinghetti, F., & Giacardi, L. <http://www.icmihistory.unito.it>
- Ifrah, G. (2000). *The universal history of numbers: From prehistory to the invention of the computer*. New York: Wiley.
- Ivrendi, A. (2011). Influence of self-regulation on the development of children's number sense. *Early Childhood Education Journal*, 39(4), 239–247.
- Jankvist, U. T. (2009). A categorization of the “whys” and “hows” of using history in mathematics education. *Educational Studies in Mathematics*, 71(3), 235–261.
- Kanes, C., Morgan, C., & Tsatsaroni, A. (2014). The PISA mathematics regime: Knowledge structures and practices of the self. *Educational Studies in Mathematics*, 87(2), 145–165.
- Keller, O. (2016). *l'invention du nombre*. Paris: Garnier.
- Kilpatrick, J. (2012). The new math as an international phenomenon. *ZDM: Mathematics Education*, 44(4), 563–571.
- Klein, D. (2007). A quarter century of US “math wars” and political partisanship. *BSHM Bulletin*, 22, 22–33.
- Lam, L. Y., & Ang, T. S. (2004). *Fleeting footsteps: Tracing the conception of arithmetic and algebra in ancient China*. Singapore: World Scientific.
- Leung, F. K. (2014). What can and should we learn from international studies of mathematics achievement? *Mathematics Education Research Journal*, 26(3), 579–605.
- Leung, F. K., Graf, K. D., & Lopez-Real, F. J. (Eds.). (2006). *Mathematics education in different cultural traditions: A comparative study of East Asia and the West: The 13th ICMI study*. New York: Springer.
- Ma, L. (1999). *Knowing and teaching elementary mathematics: Teachers' understanding of fundamental mathematics in China and the United States*. Mahwah: Lawrence Erlbaum Associates.
- Mainzer, K. (1991). Natural numbers, integers and rational numbers. In H.-D. Ebbinghaus et al., *Numbers* (with an introduction by K. Lamotke; H.L.S. Orde, Trans.; J.H. Ewing, Ed.) (pp. 9–26). New York: Springer. (Original work published 1983)
- Margolinas, C., & Wozniak, F. (2012). *Le nombre à l'école maternelle: Une approche didactique*. Bruxelles: De Boeck.
- Martzloff, J.-C. (1997). *A history of Chinese mathematics*. Berlin-Heidelberg: Springer.
- May, K. O. (1973). *Bibliography and research manual of the history of mathematics*. Toronto: University of Toronto Press.
- McDonald, M. (2013, September 13). Frustrated professors convince elementary schools to step back from “new math” and go “back to basics”. *The National Post*. Retrieved from <http://news.nationalpost.com/2013/09/13/frustrated-professors-convince-schools-to-step-back-from-new-math-and-go-back-to-basics/>
- McIntosh, A., Reys, B., & Reys, R. (1992). A proposed framework for examining basic number sense. *For the Learning of Mathematics*, 12(3), 2–8.
- Menninger, K. (1969). *Number words and number symbols: A cultural history of numbers*. Cambridge, MA: The MIT Press. (Translated from the German edition of 1958).
- Miller, K. F., & Zhu, J. (1991). The trouble with teens: Accessing the structure of number names. *Journal of Memory and Language*, 30(1), 48–68.
- Morrish, I. (2013). *Aspects of educational change (RLE Edu D)*. London: Routledge.
- Needham, J. (1959). *Science and civilisation in China. Vol. 3: Mathematics and the sciences of the heavens and the earth*. Cambridge: Cambridge University Press.

- Perret, J. F. (1985). *Comprendre l'écriture des nombres*. Bern: P. Lang.
- Prenzel, M., Blum, W., & Klieme, E. (2015). The impact of PISA on mathematics teaching and learning in Germany. In K. Stacey & R. Turner (Eds.), *Assessing mathematical literacy: The PISA experience* (pp. 239–248). Cham: Springer International.
- Proust, C. (2008). Quantifier et calculer: Usages des nombres à Nippur. *Revue d'histoire des mathématiques*, 14(2), 143–209.
- Proust, C. (2009). Numerical and metrological graphemes: From cuneiform to transliteration. *Cuneiform Digital Library Journal*, 1.
- Ruthven, K. (1998). The use of mental, written and calculator strategies of numerical computation by upper primary pupils within a 'the calculator-aware' number curriculum. *British Educational Research Journal*, 24(1), 21–42.
- Ryan, J. (1827). *An elementary treatise on arithmetic, in theory and practice*. New York: Collins & Hannay.
- Saxe, G. B. (1981). Body parts as numerals: A developmental analysis of numeration among the Oksapmin in Papua New Guinea. *Child Development*, 52(1), 306–316.
- Schmandt-Besserat, D. (1992). *Before writing* (Vol. 2). Austin: University of Texas Press.
- Seidenberg, A. (1962). The ritual origin of counting. *Archive for History of Exact Sciences*, 2(1), 1–40.
- Sun, X., Neto, T. B., & Ordóñez, L. E. (2013). Different features of task design associated with goals and pedagogies in Chinese and Portuguese textbooks: The case of addition and subtraction. In C. Margolinas (Ed.), *Task design in mathematics education. Proceedings of ICMI study 22, July 2013, Oxford, United Kingdom* (pp. 409–418). Retrieved from <https://hal.archives-ouvertes.fr/hal-00834054v3>
- Tempier, F. (2013). *La numération décimale de position à l'école primaire: une ingénierie didactique pour le développement d'une ressource*. Doctoral dissertation. Paris: Université de Paris Diderot – Paris 7.
- Thompson, I. (1999). Implications of research on mental calculation for the teaching of place value. *Curriculum*, 20(3), 185–191.
- Wiseman, A. W. (2013). Policy responses to PISA in comparative perspective. In H.-D. Meyer & A. Benavot, *PISA, power and policy. The emergence of global educational governance* (pp. 303–322). Oxford: Symposium Books.
- Zhao, Y. (2005). Increasing math and science achievement: The best and worst of the east and west. *Phi Delta Kappan*, 87(3), 219–222.

Cited papers from Sun, X., Kaur, B., & Novotna, J. (Eds.). (2015). Conference proceedings of the ICMI study 23: Primary mathematics study on whole numbers. Retrieved February 10, 2016, from www.umac.mo/fed/ICMI23/doc/Proceedings_ICMI_STUDY_23_final.pdf

- Azrou, N. (2015). Spoken and written arithmetic in post-colonial country: The case of Algeria (pp. 44–51).
- Bass, H. (2015). Quantities, numbers, number name, and number line (pp. 10–20).
- Beckmann, S., Izsák, A., & Ölmert, I. B. (2015). From multiplication to proportional relationships (pp. 518–525).
- Cao, Y. Li, X., & Zuo, H. (2015). Characteristics of multiplication teaching of whole numbers in China: The application of the nine times table (pp. 423–430).
- Chambris, C. (2015). Mathematical foundations for place value throughout one century of teaching in France (pp. 52–59).
- Changsri, N. (2015). First grade students' mathematical ideas of addition in the context of lesson study and open approach (pp. 60–67).

- Cooper, J. (2015). Combining mathematical and educational perspectives in professional development (pp. 68–75).
- Dorier, J.-L. (2015). Key issues for teaching numbers within Brousseau's theory of didactical situations (pp. 76–83).
- Ejersbo, L., & Misfeldt, M. (2015). The relationship between number names and number concepts (pp. 84–91).
- González, S., & Caraballo, J. (2015). Native American cultures tradition to whole number arithmetic (pp. 92–98).
- Hodgson, B. R., & Lajoie, C. (2015). The preparation of teachers in arithmetic: A mathematical and didactical approach (pp. 307–314).
- Houdement, C., & Tempier, F. (2015). Teaching numeration units: Why, how and limits (pp. 99–106).
- McGarvey, L., & McFeetors, J. (2015). Reframing perceptions of arithmetic learning: A Canadian perspective (pp. 115–123).
- Sayers, J., & Andrews, P. (2015). Foundational number sense: The basis of whole number arithmetic competence (pp. 124–131).
- Siu, M. K. (2015). Pedagogical lessons from Tongwen Suanzhi (同文算指) – transmission of Busan (算 written calculation) in China (pp. 132–139).
- Sun, X. (2015). Chinese core tradition to whole number arithmetic (pp. 140–148).
- Thanheiser, E. (2015). Leveraging historical number systems to build an understanding of base 10 (pp. 149–156).
- Zou, D. (2015). Whole number in ancient Chinese civilisation: A survey based on the system of counting-units and the expressions (pp. 157–164).

Open Access This chapter is licensed under the terms of the Creative Commons Attribution 4.0 International License (<http://creativecommons.org/licenses/by/4.0/>), which permits use, sharing, adaptation, distribution and reproduction in any medium or format, as long as you give appropriate credit to the original author(s) and the source, provide a link to the Creative Commons license and indicate if changes were made.

The images or other third party material in this chapter are included in the chapter's Creative Commons license, unless indicated otherwise in a credit line to the material. If material is not included in the chapter's Creative Commons license and your intended use is not permitted by statutory regulation or exceeds the permitted use, you will need to obtain permission directly from the copyright holder.



Chapter 6

Reflecting on the What and Why of Whole Number Arithmetic: A Commentary on Chapter 5



Roger Howe 

6.1 Introduction

Whole number arithmetic is a basic part of mathematics education everywhere, and there is a tendency, among mathematicians especially, but also I believe among mathematics educators, to think of it as ‘easy’ or ‘simple’, and in comparison to later parts of the curriculum – fractions, algebra, etc. – this attitude has some validity.

But, even WNA is not simple! At least, if history can be a guide to what is simple and what is hard, then Chap. 5 shows that our current, essentially universal, formulation of arithmetic in terms of base-ten place value notation (PVN) is not simple. It is the product of a very long historical development, some parts of which are still little understood. PVN has won its worldwide acceptance and use, not because it is simple, but for the power it brings to numeration and calculation; because once you understand it – or at least, can work with it – many other things are simple. Although PVN has that characteristic feature of a great idea – that after you learn it, you can’t imagine not knowing it – it presents considerable obstacles to the learner, and many students master it only partially. PVN is not obvious. Chapter 5 gives us some perspective on why this is so.

R. Howe (✉)
Yale University, New Haven, CT, USA
e-mail: roger.howe@yale.edu

6.2 Problematics of Place Value Notation

As we learn in Chap. 5, the ancient or classical civilisations – Mesopotamian (Sumerian, Babylonian, etc.), Egyptian, Chinese, Indus Valley, Greek and Roman – although they used a lot of mathematics and did complicated calculations, none of them developed positional notation (although, in some sense, the Chinese came close). It seems to have come into being in South or Southeast Asia, perhaps not until the early centuries of the CE, as a result of interactions between Chinese merchants and various neighbours of China, more specifically as a result of trying to adapt Chinese computational methods to written form. The Chinese certainly had a highly developed base-ten arithmetic, and they already had many of the components of place value notation, especially as embedded in their computational tools, but their written numbers included explicit symbols for each base-ten unit. They had no symbol for zero; if the multiple of a particular unit needed to express a given number was zero, the unit was just omitted from the writing. The Romans used a base-ten system, but their notation was more or less what is designated in Sect. 5.2.3.2 as a system of ‘additive type’, with no digits. They had separate symbols for each base-ten unit and also one for five of each unit, and they used subtraction as well as addition to express numbers. Although we think of the classical Greeks as strong mathematicians and they did marvellous things in geometry, their conception of number was not as advanced. The Greek numeration system was quite ad hoc and limited. It used combinations of up to three letters to express numbers up to 999. (As related in a draft version of Chap. 5, the Hebrew and early Arabic systems were similar – was this perhaps a common legacy from Phoenician practice, as with their alphabets themselves?) So the late development of place value notation, along with the gradual evolution of the computational algorithms after it was invented, provides convincing historical evidence that PVN is far from obvious.

Carl Friedrich Gauss (1777–1855) is often named as the best post-Renaissance European mathematician. Although pure mathematicians today revere him especially for his contributions to number theory, he also was an accomplished applied mathematician. He did massive calculations by hand, including a determination of the orbital motion of the large asteroid/dwarf planet *Ceres*, from only a very few observations of its position. His prediction of where in the sky to find it again led to its rediscovery and its establishment as a notable member of the solar system.

Gauss’s experiences with computation made him highly sensitive to the virtues of place value notation. He is quoted (Eves 1969) (Newman 1956, p. 328) as saying:

The greatest calamity in the history of science
was the failure of Archimedes
to invent positional notation.

Here, the main point is that even Archimedes, perhaps the best of classical Greek mathematicians, had not come up with the idea of place value notation. This was not because Archimedes never thought about large numbers: he wrote a paper called *The Sand Reckoner*, whose theme was precisely how to express large numbers (such

as the number of grains of sand in all the beaches of the world), and which discussed ways of constructing and naming such numbers. Nevertheless, the concept of an efficient, all-purpose, unlimited system for writing numbers, such as is provided by place value notation, did not figure in his proposals. One might wonder whether the very limited ad hoc system (described above) in common use by classical Greeks and, in particular, its lack of use of multiplication, somehow inhibited Archimedes' thinking.

6.3 Algebraic Structure and the Power of Place Value Notation

If PVN was so highly valued even by Gauss, it is worth looking at carefully. As noted in Sect. 5.2.1, positional notation harnesses many concepts, including essentially all of basic polynomial algebra, in the service of simply writing numbers. Moreover, it owes its computational efficacy to its compatibility with algebraic structure. It also relies on numerous conventions that must be understood by the reader in order to interpret base-ten numbers correctly. Three different interpretations or elaborations of place value notation are mentioned in Sect. 5.2.3.6 of Chap. 5 as having been taught in France in recent years (in addition to the 'academic theory' promoted by the New Math). My paper for the Study Conference (Howe 2015) describes a slightly more elaborated sequence of interpretations, five in all, that includes all of these in a single developmental scheme that might be taken as five stages of place value understanding and that could describe the progression of a learner through a carefully designed arithmetic curriculum. They are illustrated by the following sequence of equations:

$$\begin{aligned}
 456 &= 400 && + & 50 && + & 6 \\
 &= 4 \times 100 && + & 5 \times 10 && + & 6 \times 1 \\
 &= 4 \times (10 \times 10) && + & 5 \times 10 && + & 6 \times 1 \\
 &= 4 \times 10^2 && + & 5 \times 10^1 && + & 6 \times 10^0
 \end{aligned}$$

The first interpretation of '456' mentioned in Sect. 5.2.3.6 is more or less the way '456' is read out loud in English. (Apparently, the practice is different in France, with the base-ten units suppressed.) The second and third interpretations agree with the second and third stages above.

The second stage breaks the number up into a sum of pieces. In terms of PVN, each of these pieces involves only one non-zero digit. This stage displays the basic strategy of expansion in a given base: every number can be expressed as a *sum* of pieces of a special kind. Remarkably, there appears to be no standard short name for these pieces in the mathematics or mathematics education literature. For present purposes, we will refer to them as *base-ten pieces*.

Thus, the base-ten pieces of 456 are 400, 50 and 6. This explicit decomposition of a number into the sum of its base-ten pieces is often presented in US classrooms under the name *expanded form*.

The base-ten pieces of a number themselves have substantial structure, which are to be understood in terms of multiplication. The third to fifth stages of PVN reveal successive features of this multiplicative structure.

The first aspect of this structure is that each base-ten piece is a multiple of an even more special quantity, a *base-ten unit*. These are the base-ten pieces whose non-zero digit is just 1. A general base-ten piece is a multiple of a base-ten unit, and the non-zero digit tells us what that multiple is. Thus, $400 = 4 \times 100$, $50 = 5 \times 10$ and $6 = 6 \times 1$. Thus, the base-ten units here are 100, 10 and 1.

With this terminology, we can say:

Each base-ten piece is a digit times a base-ten unit.

This is what the third stage is telling us. It might be called the ‘second expanded form’.

We should not stop with this stage. The base-ten units themselves have multiplicative structure, and this structure is really the key to the efficacy of the idea of base-ten expansion, so it should be made explicit.

Each base-ten unit is itself a product: a repeated product of 10s. The base-ten unit 1 indicates the basic unit of the whole system. It stands for whatever quantity you are counting. As revealed already by prehistoric tally systems, all whole numbers are obtained by iterating the basic unit sufficiently many times. The next base-ten unit, 10, is the key to the whole system. It reveals the *base* or grouping ratio: each successive base-ten unit is obtained by combining 10 of the previous unit. Thus, $10 = 10 \times 1$ is the first base-ten unit beyond unity. The next base-ten unit is $10 \times 10 = 100$. The next one is $10 \times 100 = 1000$, and on and on, for as long as we need to go. For most everyday purposes, we don’t have to go too far: since each base-ten unit is ten times the next smaller one, these numbers get large fast! In our example, we only need the first three units – 1, 10 and 100. The standard Greek, Hebrew and Arabic notational system was content with representing numbers only up to 999. Roman numerals went somewhat farther but not much.

Finally, the last expression summarises the previous one by expressing the iterated products of 10 with itself in exponential notation. It is the ‘academic theory’ (see Sect. 5.2.3.6) specialised to base ten. The expression bears strong resemblance to the way polynomials are written in algebra and indeed can be thought of as expressing the given number as a ‘polynomial in 10’, with the understanding that the ‘coefficients’ of the ‘polynomial’, i.e. the digits in the first expression, are all whole numbers less than 10.

From an educational perspective, a key point to realise about the five stages of place value is that although to a mature understanding all these expressions are more or less obviously equivalent, each stage represents a substantial intellectual advance on the previous one. For example, exponential notation is justified using the associative rule for multiplication, which is arguably the deepest of the rules of arithmetic. Correspondingly, exponential notation is usually not introduced until late elementary

school – not in the primary grades – and well after PVN has already been in use by students with 3–5-digit (or more) numbers. (However, this late introduction is probably not done to allow a principled discussion of the role of the associative rule in defining exponential notation!) Taken all together, understanding the five stages implies a lengthy intellectual development that requires, if it is achieved at all, the full span of elementary education.

6.4 Possible Lessons for Education

All this is well known to mathematics educators, but it seems worthwhile to rehearse it again here, for several reasons.

First, it can help us to see to what may be some omissions in educational discourse and in WNA instruction. The first example of this would be the lack of a short name for talking about the basic building blocks of the notation, what we are here calling the ‘base-ten pieces’. A short name would facilitate discussion of them and their role in PVN, thereby promoting conceptual understanding of PVN.

Further on, we should ask to what extent the full structure revealed in the fifth expression, that is, the algebraic structure implicit in PVN, is made clear to students. Some evidence suggests that, in the United States, even the third stage, the ‘second expanded form’, does not become part of the thinking of a large segment, perhaps a majority, of students (Thanheiser 2009, 2010). We should consider how to structure our curricula so that the ideas embodied in the five stages of place value, and the algebraic structure underlying it, are absorbed by students. This would be consistent with the ‘higher-order thinking’ mantra of twenty-first century education.

Second, the unlimited nature of place value notation is brought home when we use exponential notation to express base-ten pieces as $d \times 10^k$, where we understand that k can be any whole number. The WNA curriculum as we have inherited it from previous centuries might be described as ‘small-number-centric’ (which was appropriate for many of its primary justifications, e.g. ‘shopkeeper arithmetic’). It starts with single digits, proceeds to two-digit numbers, then to three- and four-digit numbers, and then perhaps with a little attention to five- and six-digit numbers, tends to think its job is done. This is probably fine if the main goal of instruction is to enable people to calculate correctly with medium-sized numbers, but it does not convey a sense of the system as a whole. This small-number focus may be part of the reason many people have little appreciation for the difference between a million and a billion, thinking of both of them simply as ‘very big numbers’.

But one can argue that today, it is an important civic skill to understand the difference between a million and a billion. To understand, for example, that a billionaire is equivalent to a thousand millionaires.¹ If a billionaire spends 10 million dollars on a house and takes a million dollar vacation each year, he still has about \$950 million left to do other things with. When Bill Gates built his house, everyone

¹This is in the USA. In England, ‘billion’ means ‘million million’.

was agog that he spent 40 million dollars on it. But Gates' net worth at the time was 40 billion dollars, so he was spending 0.1% of his net worth on the house. What kind of a house could you buy for 0.1% of your net worth? In this context, it should also be taken into account that rich people do not keep their money under their pillows, they invest it: their money makes more money. If Gates' fortune was increasing at just 1% per year (in fact, it was increasing much faster), he was richer after he paid for the house than when he signed the contract to have it built.

Furthermore, to discuss intelligently economic constructs such as gross national product, billions are not enough; one needs at least trillions. For example, the GDP of the United States in 2015 was about 18 trillion dollars.

Discussion of issues like climate change involves comparing numbers that are substantially larger than this. For example, how big is Earth's atmosphere? The weight of the atmosphere is about 15 pounds per square inch (atmospheric pressure) times the area of Earth in square inches. How many pounds is that? Computations like this one also bring home the point that, not only would it be very cumbersome to attempt to compute all the digits in a large number, it would be a waste of time.

With some effort, one can compute by hand that the number of square inches in a square mile is 4,014,489,600. (This computation does not exceed the capacity of many hand calculators, so a modern child can find it with a few keystrokes – if she/he knows what to do.) Then all we have to do is multiply this by the area of Earth in square miles. But how accurately can we know this? Do we want to try to find the exact true area of Earth in all its glorious roughness? This does not even make sense. Most of the surface of Earth is water, which is constantly being jostled by the wind to form waves. Waves change the surface area of water, sometimes quite drastically. (Think of 'The Great Wave off Kanagawa' in Hokusai's woodblock print. Some would put this forward as an example of a fractal, with infinite surface area.) A simpler approach might be to pretend that Earth is a sphere and use the formula $A = 4\pi r^2$ for its area. To carry out this strategy, you have to confront the facts that (i) Earth is not in fact a sphere and, in particular, (ii) its 'radius' is not exactly defined. In fact, the 'radius of Earth' does not make sense to much more accuracy than ± 5 miles.² Since it is approximately 4000 miles, this means that we know the radius of Earth to less than three significant figures. Keeping in mind the principle that a product is only known as accurately as the least accurate of its factors, it does not make sense to report more than the three largest base-ten pieces in describing the area of Earth or the weight of the atmosphere. So our lovely calculation above of the number of square inches in a square mile could (and should) just be replaced by 'approximately 4 billion'. The corresponding figure for the area of Earth in square inches is quite adequately represented by 800,000,000,000,000,000 or 800 quadrillion (in US numeration).

To successfully teach children to comprehend and work with numbers this large, we have to get away from focusing on the digits and work hard to understand the sizes of the pieces: to focus more attention on the base-ten pieces, especially the

²There are several reasons for this: oblateness (flattening at the poles), the bulge in the North Pacific, mountains and ocean trenches, etc.

base-ten units and their relative sizes. Furthermore, students need to learn that, as in the example of ‘radius of Earth’, in the real world, it is rare either to need to know, or even to be able to know, more than the two or three largest base-ten pieces in the number describing some quantity. For most practical purposes, a number is a two- or three-digit number times a (perhaps large) power of 10. This might be a goal for WNA in the twenty-first century.

It is tempting to speculate why the New Math reform of the 1960s did not articulate the process of learning place value as completely as the five-stage description offered above. Perhaps it was a lack of pedagogical insight on the part of participating mathematicians or, more precisely, failure to appreciate the intellectual advances and the years of development needed to progress from one stage to the next. Perhaps it was a residue of the somewhat contemptuous attitude some mathematicians harbour towards base-ten notation, since it involves arbitrary choices and, especially, selection of a base, for which there is no clear mathematical reason. This might explain the introduction of arbitrary bases in the New Math. Perhaps it was because they were still so starry-eyed about the triumph of set theory in establishing foundations for mathematics that mundane classroom issues such as arithmetic did not engage their attention. Whatever the reason(s) behind it, this failure can serve as an exhibit for the claim that mathematical expertise is not the only prerequisite for understanding and positively influencing mathematics education.

6.5 Comments on Particular Sections of Chapter 5³

6.5.1 Comments on Section 5.3.1

The linguistic issues of teaching the base-ten place value system are perhaps the feature of WNA that benefits most from cross-national comparisons. In the USA, we have been aware since the paper (Miller and Zhu 1991) pointing out the strict compatibility of Chinese spoken number names with PVN and the comparative disadvantage English speakers have in learning the principles of place value, since they are obscured at the beginning by the irregularity of the -teen numbers and, to a somewhat lesser extent, of the -ty numbers. However, we learn in Sect. 5.3.1.1 that English presents relatively mild problems and that several European languages such as French and Danish are much worse in this regard. My heart goes out to Danish school children trying to make sense of 70 when the name for it is ‘three and a half four’!

³The section numbers refer to sections of Chap. 5.

6.5.2 *Comments on Section 5.3.1.2*

In Sect. 5.3.1.2, we learn that children in Algeria have the added burden of trying to translate between several different vernaculars with contradictory conventions, compounded by translational ambiguities.

Perhaps a way to help children get around this kind of linguistic obstacle is to treat the base-ten system for what it is in almost all countries – an imported piece of a foreign language – and to make the translation from traditional number names to ‘structural names’, or ‘mathematics names’, that explicitly describe the base-ten structure of each number, a topic of study. This would include explicitly discussing the -teen numbers as being made from one 10 and some 1s and making sure that students could translate between their traditional names and the structural descriptions. Likewise, the -ty numbers (20, 30, ..., 90) would be explicitly identified as a certain number of tens and the general two digit numbers as being the sum of some 10s and some 1s. The work of Fuson (e.g. Fuson and Briars (1990), Fuson et al. (1997)) gives some support to this approach.

Beyond helping children to translate between their traditional names and the quantity meanings of numbers with two or three digits, this approach would have the advantage of permitting explicit attention to be paid to the base-ten pieces and how the base-ten structure facilitates computation. General rules could be enunciated that describe what needs to be done to add or to multiply.

When adding two base 10 numbers, we add the 1s (from the two numbers) together, we add the 10s together, we add the 100s together, etc. Then, if we get more than 10 of any base 10 unit, we convert 10 of it to 1 of the next higher unit.

When multiplying two numbers, we multiply each base 10 piece of one factor, with each base 10 piece of the other factor. Then we sum all these products.

The multiplication of two base 10 pieces amounts to multiplying their digits, and multiplying the base 10 units, and taking the product of these.

These descriptions can be stated briefly or more completely, as appropriate for the context. Besides encapsulating the main principles of base-ten computation in compact form, these general rules have the advantage that they can be taught progressively, starting with two-digit addition and one-digit by two-digit multiplication, and can be formulated more and more generally as students work with larger numbers. The standard column-wise procedures for paper-and-pencil calculation can then be presented as mechanically simple ways to actualise the principles of addition and multiplication formulated as above. This approach would also easily afford discussion of the role of the rules of arithmetic in ensuring that the general recipes formulated above are valid. All this would in turn prepare students for learning the later stages of place value, in the list of five stages given above, and give them a chance of understanding the whole system, which currently seems to be a rare accomplishment.

6.5.3 Comments on Section 5.4.2

The misunderstanding, between the university mathematician Rick and several K-12 mathematics teachers, mentioned by Cooper (2015), makes an interesting study for another mathematician. The miscommunication may have occurred in the interpretation of ‘numerical expression’. Rick may have meant this to mean, ‘Does this symbol “8(1)” signify a number?’, while the teachers may have taken it to mean, ‘Is this a well-defined expression involving numbers?’ It is the latter, but it is not the former.

The situation is primed for confusion by the frequent use of the word ‘division’ to signify either division in the usual sense of rational numbers or division with remainder (DWR).

DWR is not an operation on whole numbers in the same sense that addition or multiplication is an operation. That is to say, DWR does not take a pair of whole numbers and return a single whole number: it produces a *pair* of whole numbers, which play very different roles in the process of DWR. One number is the DWR ‘quotient’ and the other number is the remainder. Considered in this way, DWR defines a somewhat complicated function from pairs of whole numbers to pairs of whole numbers. It is a rather different animal from rational number division, which takes a pair of rational numbers and returns a *single* rational number.

The confusion is further encouraged by the use of the notation 25:3, which is very similar to the usual fraction notation $25/3$ (and probably intended to be similar!). The symbol $25/3$ denotes the (rational) number x such that $3x = 25$. However, the notation 25:3 stands for the pair of whole numbers q and r , such that $3q + r = 25$, with r understood to satisfy $0 \leq r < 3$. These numbers are of course 8 and 1.

To emphasise the difference between DWR and the operation of division for rational numbers, instead of writing $25:3 = 8(1)$, which is trying to make DWR look as much as possible like actual rational number division (RND), we might try to emphasise the distinction and try to make DWR look different from RND. To do this, we might define the ‘DWR function’, which would take a pair of whole numbers (n,d) to the pair of numbers (q,r) such that $n = qd + r$, with the remainder r understood to satisfy the key condition $0 \leq r < d$. Thus, we would write

$$\text{DWR } (25,3) = (8,1)$$

to emphasise the function aspect of DWR. (This notation might not be so student-friendly, however!) The DWR function is not one-to-one (in fact, it is infinite-to-one), is not RND and indeed is not compatible with RND, or with multiplication in the whole numbers, so there should not be any expectation that, just because

$$\text{DWR } (25,3) = (8,1) = \text{DWR } (33,4) = \text{DWR } (41,5) = \text{DWR } (49,6) = \text{DWR } (57,7),$$

etc., that we can conclude that $25/3 = 41/5 = 57/7$, etc. But the notation $DWR(25,3) = 25:3$ tries to make DWR look like RND and sets things up for the confusion that Rick and his teachers experienced.

Besides the definition of the DWR relation as deriving from the equation $n = qd + r$, there is another conventional notation that can adequately express the relationships involved in DWR – the notation of mixed numbers. This would allow us to write

$$\frac{25}{3} = 8\frac{1}{3}$$

Here the conventional interpretation of the right hand side is as a sum:

$$8\frac{1}{3} = 8 + \frac{1}{3}$$

This notation is more or less equivalent to the notation that Rick proposed to the teachers, but avoids the tricky sign, whose interpretation is at the core of the confusion. Understanding that $25:3 = 8(1)$ means that $\frac{25}{3} = 8\frac{1}{3}$ and that $41:5 = 8(1)$ means that $\frac{41}{5} = 8\frac{1}{5}$ should help cure people from wanting to conclude equality of the left-hand sides implies equality of the right-hand sides. The main point to be clear on is that, while it might be defensible to call $8(1)$ a ‘numerical expression’, it is *not* a number.

6.6 Conclusion

In these comments, I have tried to reinforce the theme of Chap. 5 that WNA is not a simple matter. This can be seen in the historical development of the base-ten place value system, which was at best incompletely realised by early civilisations that began using mathematics heavily. It can also be seen in the conceptual structure, which is at best rather incompletely taught in many countries. Finding better, more effective and more conceptually complete ways of teaching WNA should be a focus of research. Finally, the fact that many issues of current importance (national budgets, climate science, big data) require dealing with large numbers that are known only approximately indicates placing more instructional emphasis on a global understanding of base-ten structure and, in particular, on the base-ten pieces and their relative sizes.

References

- Eves, H. (1969). *In mathematical circles*. Boston: Prindle, Weber & Schmidt.
- Fuson, K. C., & Briars, D. J. (1990). Using a base-ten blocks learning/teaching approach for first and second grade place-value and multidigit addition and subtraction. *Journal for Research in Mathematics Education*, 21(3), 180–206.
- Fuson, K. C., Smith, S. T., & Lo Cicero, A. (1997). Supporting Latino first graders' ten-structured thinking in urban classrooms. *Journal for Research in Mathematics Education*, 28(6), 738–766.
- Miller, K. F., & Zhu, J. (1991). The trouble with teens: Accessing the structure of number names. *Journal of Memory and Language*, 30(1), 48–68.
- Newman, J. R. (1956). *The world of mathematics*. New York: Simon and Schuster.
- Thanheiser, E. (2009). Preservice elementary school teachers' conceptions of multi-digit whole numbers. *Journal for Research in Mathematics Education*, 40(3), 251–281.
- Thanheiser, E. (2010). Investigating further preservice teachers' conceptions of multi-digit whole numbers: Refining a framework. *Educational Studies in Mathematics*, 75(3), 241–251.

Cited papers from Sun, X., Kaur, B., & Novotna, J. (Eds.). (2015). Conference proceedings of the ICMI study 23: Primary mathematics study on whole numbers. Retrieved February 10, 2016, from www.umac.mo/fed/ICMI23/doc/Proceedings_ICMI_STUDY_23_final.pdf

- Cooper, J. (2015). Combining mathematical and educational perspectives in professional development (pp. 68–75).
- Howe, R. (2015). The most important thing for your child to learn about arithmetic (pp. 107–114).

Open Access This chapter is licensed under the terms of the Creative Commons Attribution 4.0 International License (<http://creativecommons.org/licenses/by/4.0/>), which permits use, sharing, adaptation, distribution and reproduction in any medium or format, as long as you give appropriate credit to the original author(s) and the source, provide a link to the Creative Commons license and indicate if changes were made.

The images or other third party material in this chapter are included in the chapter's Creative Commons license, unless indicated otherwise in a credit line to the material. If material is not included in the chapter's Creative Commons license and your intended use is not permitted by statutory regulation or exceeds the permitted use, you will need to obtain permission directly from the copyright holder.



Chapter 7

Whole Number Thinking, Learning and Development: Neuro-cognitive, Cognitive and Developmental Approaches



Joanne Mulligan , Lieven Verschaffel 
Anna Baccaglioni-Frank , Alf Coles , Peter Gould , Shengqing He ,
Yunpeng Ma, Jasmina Milinković , Andreas Obersteiner , Nicole Roberts,
Nathalie Sinclair , Yanling Wang , Shu Xie, and Der-Ching Yang 

7.1 Introduction

7.1.1 What Was Presented at the Conference: Overview

The participants of working group 2 presented a broad range of studies, 11 papers in total, related to whole number learning representing research groups from 11 countries as follows.

Two large cross-sectional studies focused on developmental aspects of young children's number learning provide a lens for re-examining 'traditional' features of number acquisition. van den Heuvel-Panhuizen (the Netherlands) presented a co-authored paper with Elia (Cyprus; Elia and van den Heuvel-Panhuizen 2015) on a

Electronic Supplementary Material The online version of this chapter (doi:[10.1007/978-3-319-63555-2_7](https://doi.org/10.1007/978-3-319-63555-2_7)) contains supplementary material.

The first two authors wrote the chapter with the collaboration of other working group members.

J. Mulligan (✉)
Macquarie University, Sydney, NSW, Australia
e-mail: joanne.mulligan@mq.edu.au

L. Verschaffel (✉)
Katholieke Universiteit Leuven, Leuven, Belgium
e-mail: lieven.verschaffel@kuleuven.be

A. Baccaglioni-Frank
Università di Pisa, Pisa, Italy

A. Coles
University of Bristol, Bristol, UK

cross-cultural study of kindergartners' number competence focused on counting, additive and multiplicative thinking. Second, Milinković (2015) examined the development of young Serbian children's initial understanding of representations of whole numbers and counting strategies in a large study of 3- to 7-year-olds. Children's invented (formal) representations such as set representation and the number line were found to be limited in their recordings.

In a South African study focused on early counting and addition, Roberts (2015) directs attention to the role of teachers by providing a framework to support teachers' interpretation of young disadvantaged learners' representations of number when engaging with whole number additive tasks.

Some papers reflected the increasing role of neuroscientific concepts and methodologies utilised in research on WNA learning and development. Sinclair and Coles (2015) drew upon neuroscientific research to highlight the significant role of symbol-to-symbol connections and the use of fingers and touch counting exemplified by the *TouchCounts* iPad app.

Gould (2015) reported aspects of a large Australian large study of children in the first years of schooling aimed at improving numeracy and literacy in disadvantaged communities. A case study exemplified how numerals were identified by relying on a mental number line by using location to retrieve number names. This raised the question addressed in the neuroscientific work of Dehaene and other papers focused on individual differences in how the brain processes numbers.

The Italian PerContare¹ project (Baccaglini-Frank 2015) built upon the collaboration between cognitive psychologists and mathematics educators, aimed at devel-

¹The PerContare project was coordinated by Fondazione ASPHI onlus, with the support of Compagnia di San Paolo and the operative support of Fondazione per la Scuola of Compagnia di San Paolo of Torino.

P. Gould

NSW Department of Education and Communities, Sydney, NSW, Australia

S. He

Hangzhou Normal University, Hangzhou, China

Y. Ma • Y. Wang • S. Xie

Northeast Normal University, Changchun, China

J. Milinković

University of Belgrade, Belgrade, Serbia

A. Obersteiner

Technische Universität München, München, Germany

N. Roberts

University of the Witwatersrand, Johannesburg, South Africa

N. Sinclair

Simon Fraser University, Burnaby, BC, Canada

D.-C. Yang

National Chiayi University, Chiayi, Taiwan

oping teaching strategies for preventing and addressing early low achievement in arithmetic. It takes an innovative approach to the development of number sense that is grounded upon a kinaesthetic and visual-spatial approach to part-whole relationships.

Mulligan and Woolcott (2015) provided a discussion paper on the underlying nature of number. They presented a broader view of mathematics learning (including WNA) as linked to spatial interaction with the environment; the concept of connectivity across concepts and the development of underlying pattern and structural relationships are central to their approach.

One group of papers presented studies about other computational aspects of WNA such as the variation, efficiency and flexibility of representations and strategies for counting, mental arithmetic, written algorithms, computational estimation and word problems. Obersteiner and colleagues (Obersteiner et al. 2015) proposed a coherent five-level competence model for WNA in the lower grades of elementary school. In another study Verschaffel and colleagues (Verschaffel et al. 2015) compared two kinds of strategies for processing mental subtraction, namely, subtraction-by-addition. Another three different studies provided new insights into mental and written WNA strategies and errors by students in the middle elementary grades: He (2015) focused on cognitive strategies for solving addition and subtraction problems; Yang (2015) highlighted the conceptual difficulties of students' judging the reasonableness of results in whole number calculations; Ma et al. (2015) analysed students' systematic errors for three-digit multiplication and linked these errors to teaching strategies. While these studies generated rich discussion about the range of research questions that focused on computational processes linked to WNA, these studies were not considered the main focus of this chapter, which instead articulates the ICMI23 (Theme 2) position paper.

7.1.2 The Discussion of the Working Group

As in most other working groups, the eight 1-hour sessions were organised in two different forms. Whereas the first five sessions were devoted to the presentation and discussion of the participants' accepted papers, the last three whole-group sessions involved discussions, wherein two major themes were discussed. First, to what extent can the currently influential neuro-cognitive perspective, as elaborated in Butterworth's plenary lecture, act as an appropriate theoretical scope to think about early mathematical development (and stimulation of that development) or whether this perspective needs to be nuanced and enriched by other perspectives? The second major point of discussion addressed the potentialities and limitations of the methodologies utilised in the studies on children's whole number learning and development being presented in the working group (and in some other working groups) and, more specifically, of (a) the design of the cross-sectional, longitudinal and intervention studies aiming at understanding how children develop competencies with whole numbers, as well as (b) the tasks that are common to many studies

measuring the understanding of magnitude of numbers, such as number comparison and number-line estimation tasks.

Obviously, the topics dealt with in working group 2 were related to those addressed in the other working groups and panels, as will become clear through the numerous cross-references that will be provided in this chapter. However, working group 2 tried to tackle these common topics from the two perspectives mentioned above, namely, the psychological and the methodological perspectives.

7.1.3 About the Chapter

The chapter focuses essentially on two key aspects of the Theme 2 discussion (as presented in the Discussion Document, see the [Appendix 1](#) to this volume) that discussed neuro-cognitive, cognitive and developmental analyses of whole number learning. Its aim is to bring these perspectives into our discussion by acknowledging the realisations and promises of neuroscientific research while adopting a critical approach from a mathematics education perspective. The structure and content of the chapter are an outcome of our synthesis of key ideas following our discussions in working group 2. Thus, the chapter will (1) present, discuss and illustrate perspectives complementary to neuro-cognitive research and (2) discuss methodologies utilised in studies on children's whole number learning and development. There are five main sections.

The bulk of the first section (Sects. [7.1.1](#) and [7.1.2](#)) provides an overview of the ICMI Study 23 Conference presentations and the working group 2 discussion.

The second section ([7.2](#)) focuses on two neuro-cognitive perspectives: first, Butterworth's 'starter kit' is discussed in light of Butterworth's plenary paper (see [Chap. 20](#)) and his contribution to the working group discussions. Second, some related research on the triple-code model of Dehaene and colleagues (Dehaene et al. [2003](#); see also Dehaene [2011](#)) is presented. Gould ([2015](#)) then draws upon some examples from the research of how quantities and numbers are transcoded and represented.

The third section ([7.3](#)) provides an overview of related research from cognitive perspectives that informs the discussion for working group 2. Verschaffel and Mulligan develop this overview of the literature to complement the examples provided by working group 2 participants. Cross links with examples from other themes are highlighted.

The fourth section ([7.4](#)) describes some pertinent examples of studies presented to working group 2 and applications of the perspectives described in [Sect. 7.3](#): ordinality (Sinclair and Coles [2015](#)), part-whole relations (Baccaglioni-Frank [2015](#)), additive relations (Roberts [2015](#)), number competence (Elia and van den Heuvel-Panhuizen [2015](#)) and counting and representational structures (Milinković [2015](#)).

The fifth section ([7.5](#)) discusses methodological issues common to neuro-cognitive, cognitive and developmental analyses of studies on children's WNA. Cross-sectional, longitudinal and intervention studies are discussed in terms

of their appropriateness for investigating children’s competence with whole number. In that section, we also discuss task design in cognitive neuroscience research pertinent to number learning.

In the sixth section (7.6), some tentative conclusions are drawn and implications for teaching and learning and further research are discussed.

7.2 Neuro-cognitive Perspectives

7.2.1 A ‘Starter Kit’ for Early Number

The components of Butterworth’s ‘starter kit’ (Butterworth 2005) for early number learning are primarily focused on cardinal aspects of number and its importance for later mathematical development. In most cognitive neuroscientific studies, children’s foundational competencies are related to children’s general mathematical achievement as measured by standard school achievement tests of number and computation rather than other aspects of mathematical development such as spatial processes.

From a very young age, humans have an inherited core capacity for numerical processing. For example, the process of *subitising* refers to the immediate and accurate estimate of one to four objects without serial enumeration. Another core process is described as representing non-symbolic numerical magnitudes on a mental number line. Symbolic representations (3, 100, ½, 3.17...) are gradually mapped onto these non-symbolic representations. These magnitude representations are commonly assessed by means of subitising, magnitude comparison and number line estimation tasks. Examples are shown in Figs. 7.1 and 7.2, respectively.

Butterworth (see Chap. 20) describes these two foundational ‘core systems’. Deficiencies in these core systems may contribute to low numeracy. He refers to an ‘object tracking system’ that has a limit of three or four objects and is thought to underlie ‘subitising’. Another core system is the ‘analogue number system’ (ANS). ‘The internal representations of different numerical magnitudes can be thought of as Gaussian distributions of activation on a ‘mental number line’. It is typically tested

Fig. 7.1 Which is the larger set?

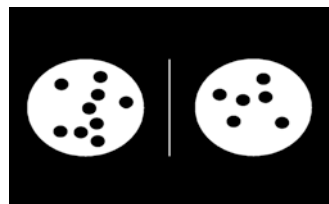
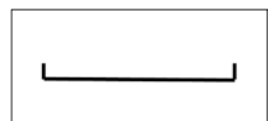

Fig. 7.2 The line begins at 0 and ends at 10. Where is the number 6 located?



by tasks involving clouds of dots (or other objects) typically too numerous to enumerate exactly in the time available' (p. 480).

Butterworth refers to the study of Australian Aboriginal children that exploited their known visual strengths to solve accurately non-standard arithmetic tasks where they had no number words to describe the quantities (Butterworth and Reeve 2008). These children matched the spatial patterns of the addend and augend sets. The findings suggested that there are various models for number that are not necessarily one-dimensional such as in the mental number line and these can be two-dimensional in nature.

Some key findings are drawn from Butterworth's research: (1) numerical magnitude understanding is positively and predictively related to (general) mathematics achievement and (2) numerical magnitude understanding can be improved by means of game-based intervention programmes, although the transfer effects from those games to mathematics learning more broadly is still rather small (see Chap. 20).

7.2.2 Neuropsychology and the Triple-Code Model

Neuropsychologists have sought to understand how brain functioning influences cognition, including mathematics and whole number learning (Dehaene 2011). Simple models associated with number processing have been proposed and tested, and the main areas of the brain identified as being activated in number processing have been refined.

Dehaene et al. (2003) proposed a triple-code model of working with number, consisting of three components: verbal, visual (numerals) and magnitude. The model postulates three main representations of numbers:

- A verbal code in which numbers are represented as a parsed sequence of words.
- A visual Arabic code in which numbers are represented as identified strings of digits.
- An analogical quantity or magnitude code.

Each part of the model has been associated with increased activity in a particular part of the brain. For example, the horizontal segment of the intraparietal sulcus has been suggested as the region involved in encoding the analogical representation of numerical magnitude (Dehaene et al. 2003).

7.2.3 Transcoding Numerals (Symbols) to Number Words

Dehaene et al. (2003) proposed two major coordinated routes: a direct asemantic route that transcodes written numerals, i.e. the symbolic notations, to verbal representations and an indirect semantic route for quantitative processing. Alternative

semantic routes are those that go through an intermediate step of activation of quantity associated with the target numeral.

In the working group 2 presentation and subsequent discussion, Gould raised the question of whether transcoding numerals to number words is limited to either semantic or asemantic pathways. Gould (2015) drew upon an example of a 7-year-old child's alternative strategy for locating and naming numerals on the number line. The discussion centred on a videoed interview with a child (Electronic Supplementary Material: Gould 2017), identified as Jed, indicating that these are not the only pathways used to transcode numerals to words. Instead of using a direct asemantic route to transcode written numerals to verbal representations, Jed used a more laborious transcoding pathway to identify numerals. Jed attempted to visualise the location of numerals on an ordered line of numbers. He would then seek the corresponding number word by counting from one. His process for identifying numerals was purposeful and time intensive, but clearly not asemantic. Gould's pertinent example shows that coding pathways associated with number may be more complex than the neuro-cognitive triple-code model currently allows. Whereas previously it was thought that Arabic numerals might activate representations of magnitude automatically, other research suggests that this is not the case (Rubinsten and Henik 2005). Gould proposes that learning to identify numerals is a learnt process. For most students, transcoding Arabic numerals to words is an asemantic process, but for some, it can rely upon a process that is not instant. For example, Frederick, a 7-year-old student in his second year of formal schooling, would regularly confuse 12 and 20. Over a period of 10 weeks, he learnt to correctly identify 12 and 20. However, to identify 12, that is, to say *twelve* in response to seeing it, Frederick counted from one to twelve subvocally.

Assessments of young children's counting often reveal the need to rely on the count from 1 (often subvocally) as the reliant strategy to 'reach' the required number name. These children are unable to move flexibly between different positions in the number sequence to count either forwards or backwards. When children move from producing an ordered sequence of counting words from 'one' to developing cardinal meaning, their understanding of the quantity is described as the count-to-cardinal transition (Fuson 1988, p. 266). What is important here is whether these children possess either cardinal or ordinal understanding of quantity or both, e.g. '12'. The findings highlighted by Sinclair and Coles (this chapter) raise further questions about ordinality – could Jed explain how numerals are ordered in a sequence? Another important observation is that the verbal processes concerned with learning the labels for Arabic numerals appear to be critical for arithmetic development between the ages of 6 and 7 years (e.g. see Göbel et al. 2014).

7.3 Beyond Neuro-cognitive Approaches: Quantitative Relations, SFOR and an Awareness of Patterns and Structures

This section provides an overview of current research that informs the research perspectives of working group 2. In this section, we will address the importance of reasoning about quantitative relations, children's spontaneous tendency to do so and their awareness of patterns and structures.

7.3.1 *Children's Early Competencies in Quantitative Relations*

It is apparent that the analysis of early mathematics-related competencies has capitalised on measures that emphasise children's numerical competencies, i.e. their subitising skills (Schleifer and Landerl 2011), counting skills (Geary et al. 1992), ability to compare numerical magnitudes (Griffin 2004) and ability to position numerical magnitudes on an empty number line (Siegler and Booth 2004). While such measures provided empirical evidence for the multicomponential nature and importance of young children's early numerical competencies (Dowker 2008), they imply a restricted view on children's early mathematical competencies and their importance for later mathematical development. Starting from Piaget's logical operations framework (e.g. Piaget and Szeminska 1952), there is a recent renewed research attention to children's quantitative reasoning skills, such as their understanding of the additive composition of number or their multiplicative reasoning skills, as well as to their importance for later mathematical learning at school (e.g. Clements and Sarama 2011; Nunes et al. 2008, 2012).

Several authors have explored the emergence and early development of these two forms of quantitative reasoning. As far as additive reasoning is concerned, various principles including the additive composition of number but also the commutativity ($a + b = b + a$), the addition-subtraction inverse ($a + b - b = a$) and the addition-subtraction complement principle ($a - b = . \rightarrow b + . = a$) have been intensively studied (Baroody et al. 2009; Bryant et al. 1999; Gilmore and Bryant 2006; Robinson et al. 2006), sometimes also in relation to children's actual use of these principles in their mental arithmetic (Baroody 1999; Peters et al. 2010). However, only few studies have explicitly addressed the question of how children's understanding of these principles affects their (later) achievement in whole number arithmetic. The limited available evidence from these few studies suggests that quantitative reasoning of this sort makes a specific contribution to achievement in whole number arithmetic. These studies highlight the importance of focusing on the relational aspects of quantitative reasoning as critical principles that contribute to strong mental computational flexibility.

7.3.2 *Spontaneous Focusing on Numbers (SFON) and Quantitative Relations (SFOR)*

The studies on the early development of children's quantitative reasoning reviewed in Sect. 7.3.1 take a typically cognitive perspective. They hardly address children's attention to, and feeling for, quantitative relations. Quantitative reasoning in these studies often relates to multiplicative thinking. Recently, researchers have started to explore children's spontaneous focusing on quantitative relations (SFOR), as a follow-up of their investigations on children's spontaneous focusing on numerosity (SFON), which has already shown to have predictive power in explaining children's later mathematical achievement (Hannula and Lehtinen 2005). McMullen, Hannula-Sormunen and Lehtinen (McMullen et al. 2014) describe SFOR as 'the spontaneous (i.e. undirected) focusing of attention on quantitative relations and the use of these relations in reasoning' (p. 218).

A central idea underlying these SFON and SFOR tendencies is that there are individual differences not only in how learners reason about mathematics and use their numerical skills in learning or testing situations, wherein children are *guided* to the mathematical elements or relations in the situation, but also how often they *spontaneously* focus on mathematical aspects of informal everyday situations. In these situations, the recognition and use of quantitative aspects of the situation are done at the child's own initiative and thus undirected and spontaneous (e.g. Hannula and Lehtinen 2005; McMullen et al. 2013, 2014). Therefore, studies on SFON and SFOR do not examine whether learners *are able to* recognise or count exact number but rather whether they *spontaneously use* their available number recognition or quantitative reasoning skills in situations where they are not explicitly guided or instructed to do so.

7.3.3 *An Integrated Perspective Focused on Patterns and Structures*

Mulligan and Mitchelmore (2009) looked beyond research on early numeracy and single mathematical content domains such as counting to identify and explain common underlying bases of mathematical development. Drawing on their seminal studies of multiplicative reasoning and representations of number, they investigated the cognitive development of mathematics through the assessment of children's conceptual structures. A strong body of research on patterning, early algebraic thinking and the role of spatial structuring in mathematical representations supported their integrated theoretical approach that young children could develop cognitively sophisticated mathematical concepts. Based on a series of related studies with diverse samples of 4–8-year-olds, they identified and described a new construct, awareness of mathematical pattern and structure (AMPS), that generalises across mathematical concepts and processes and can be reliably measured (Mulligan

and Mitchelmore 2013; Mulligan et al. 2015). Interestingly, just as McMullen et al. discuss (see Sect. 7.3.2), in their conceptualisation of AMPS, Mulligan and Mitchelmore (2009, p. 39) also look beyond children's ability in developing early numerical competence, by stating that AMPS may consist of 'two interdependent components: one cognitive (knowledge of structure) and one meta-cognitive, i.e., "spontaneous" (a tendency to seek and analyze patterns)'. Both are likely to be general features of how students perceive and react to their environment, according to these authors. In line with this construct of AMPS is the discussion in working group 5 on structure, also referring to the notion of structuring for mathematical competence and the work of John Mason (see working group 5, Chap. 13).

Mathematical pattern involves any predictable regularity involving number, space or measure such as number sequences and geometrical patterns. Structure refers to the way in which the various elements are organised and related such as iterating a single 'unit of repeat' (Mulligan and Mitchelmore 2009). AMPS involves structural thinking based on recognising similarities and differences and relationships, but also a deep awareness of how relationships and structures are connected. Spatial structuring abilities provide the essential structural organisational features supporting numerical processes such as estimation of group size, multiplicative awareness of an array, iterating a unit of repeat in a repetition or equal partitions on a number line.

An interview-based assessment instrument was developed and validated, the *Pattern and Structure Assessment – Early Mathematics* (PASA) (Mulligan et al. 2015), across a wide range of concepts including patterning, spatial visualisation and early graphical representation. Responses included drawn representations and verbal explanations of patterns and relationships. Five broad levels of structural development were identified and described: prestructural, emergent, partial, structural and advanced structural (e.g. see Mulligan and Mitchelmore 2013). Further validation studies indicated that high levels of AMPS were correlated with high performance on standardised achievement tests in mathematics with young students (Mulligan et al. 2015). The PASA yields an overall AMPS score as well as scores on five individual structures (*sequences, shape and alignment, equal spacing, structured counting and partitioning*). All of these structures are highly interrelated. Repeating pattern sequences, equal spacing and structured counting all involve the idea of equal groups or units; shape and alignment considerations often result in equal groups; and partitioning requires the construction of equal groups or parts. In Chap. 16, a description of these structural groupings is provided in view of identifying common characteristics of AMPS that are often lacking in children with mathematics learning difficulties (MLD).

In alignment with the assessment of AMPS, an innovative, highly challenging alternative learning programme, the *Pattern and Structure Mathematics Awareness Program* (PASMMap), was developed and evaluated longitudinally in the kindergarten (the first year of formal schooling in Australia). This study provided the empirical evidence that young children are capable of representing, symbolising and generalising mathematical patterns and relationships, albeit at an emergent level (Mulligan et al. 2013). These findings suggest that restricting early learning to basic

counting, simple arithmetic and informal notions of measure and geometry limits the development of AMPS. The study also tracked and described children's individual profiles of mathematical development, and these analyses showed that core, underlying mathematical concepts are based on AMPS and that some students develop these more readily and in more complex ways than others.

The PASMMap programme develops integrated learning experiences aimed at promoting visual memory, abstraction and generalisation, suitable for young students. Each PASMMap learning 'pathway' is directed mainly towards one or more of the five core structural groupings described above. The initial pathways include pattern as unit of repeat and growing patterns, grid structure, two-dimensional and three-dimensional relationships, structuring base ten, partitioning and sharing, equal grouping, unitising in measurement and symmetry and transformations. The first pathways are followed by more challenging tasks that link with the previous pathways and extend to multiplicative patterns, metric measurement, patterns in data and angles, direction and perspective taking. Clearly there is a strong thread of spatial structuring inherent in the pathways of learning.

In summary, there are strong connections among the theoretical approaches discussed in this section. They all highlight the importance of quantitative relations, patterns and structures as fundamental to whole number arithmetic. Recognising children's spontaneous attention to quantities can be linked to the development of AMPS that also focuses on children's natural tendency to seek structure in forming numerical relationships. In this respect, it is interesting to point to the paper presented by Sayers and Andrews (2015), which was presented in working group 1, but which also addressed the question of the foundations of number sense in a remarkably broad way. By summarising the recent research work in this domain, these authors arrived at a multidimensional framework, which they have called foundational number sense (FoNS), that comprises the following eight categories: number recognition, systematic counting, awareness of the relationship between number and quantity, quantity discrimination, an understanding of different representations of number, estimation, simple arithmetic competence and awareness of number patterns. This framework provides us, to some extent, with a comprehensive picture of early number competence that was also discussed in working group 2. The features that are not evident in this framework, i.e. awareness of mathematical patterns and structure (AMPS) and spontaneous focusing on number (SFON) and on relations (SFOR), are taken up in the working group 2 discussion.

7.4 Exemplars of Classroom Studies from Cognitive Perspectives

In this section, we describe some pertinent examples of intervention studies presented to working group 2 or other applications of the perspectives described in Sect. 7.3: ordinality (Sinclair and Coles 2015), the Italian *PerContare* project

focused on structural relationships in arithmetic (Baccaglini-Frank 2015), improving early numeracy through additive relations (Roberts 2015), a cross-cultural study of kindergartners' number competence (Elia and van den Heuvel-Panhuizen 2015) and counting and representational structures (Milinković 2015).

7.4.1 Ordinal Awareness in Learning Number

For studies on ordinality, we draw on the work of Sinclair and Coles (2015). This raises an important question concerning typical developmental sequences posited by theories of early number learning, where what is given emphasis in the first years of schooling is training children to associate numbers with counting and matching sets of objects. Their research has led to the hypothesis that what is significant in the learning of number (and mathematics more generally) is not being able to link symbols to objects in a manner that is often considered accessible or natural but being able to link symbols to other symbols.

Sinclair and Coles (2015) make a distinction, in relation to number, between ordinal and cardinal aspects. They refer to *ordinality* as the capacity to place number words and numerals in sequence: for example, to know that 4 comes before 5 and after 3 in the sequence of natural numbers. Other aspects of ordinality, such as the use of ordinal names and symbols such as 'first' and '1st', may be common, for instance in the French tradition. Cardinality refers to the capacity to link number symbols to collections, e.g. to know that '4' is the correct representation to denote a group of four objects. They assert that the current emphasis on cardinal awareness in learning number may be misplaced (Coles 2014) and they have been exploring what is involved in developing greater ordinal awareness of number and what are the potential benefits?

Recent neuroscientific studies (e.g. Lyons and Beilock 2011) have challenged the dominant cardinal view of numerical cognition. Lyons and Beilock found a 'distance effect' persisted with the order comparison of groups of dots, but, importantly, when judging the order of numerals, the distance effect is reversed. In other words, when asked if three numerals are in order, the closer they are together, the quicker it is found that subjects can typically make the judgement of correct ordering or not. Lyons and Beilock used this reversal of the distance effect to suggest that the brain is doing something different when making ordinal comparisons of numerals, compared with both cardinal comparisons (of numerals or dots) and compared with ordinal comparisons of dots.

A common approach to working on ordinality in schools involves practising the number song; children are invited to count in ones up to 5 or 10, then 20 and then 100. While Sinclair and Coles see much value in this practice, as a first way of introducing children to the language and sounds of numbers, working on the successor function for integers does not exhaust the potential of ordinal awareness. This has already been made evident in the work of Gattegno (1974), whose curriculum for early number was based on developing awareness of relations among lengths, where

what is symbolised are relations between objects (greater than, less than, double, half), rather than, say, using numerals to label ‘how many’ objects are in a collection. Gattegno introduced work on place value as a linguistic ‘know-how’ and not something that required ‘understanding’. Similarly, the research discussed in working group 1 (Chap. 5) and also in Chap. 3 refers to the important role of language in labelling numbers. Gattegno also made extensive use of fingers (both the teacher’s and the children’s) as haptic symbolic devices for working on number relations, with a focus on correspondence and complementarity. Sinclair and Coles see awareness of number, in this curriculum, arising out of linguistic skill and awareness of relations in a manner that does not emphasise nor require a cardinal focus on counting collections.

Sinclair and Coles direct attention to the importance of ordinality in researching the use, in the context of the early learning of number, of an innovative iPad app, *TouchCounts* (Sinclair and Jackiw 2011). The discussion in Chap. 9 also refers to the use of *TouchCounts* as a tool for learning. *TouchCounts* was initially designed as a counting environment, to help children learn about one-to-one correspondence. Every time a finger touches the screen, a yellow disc appears, labelled with a numeral, and that numeral is spoken aloud. Each subsequent touch produces a yellow disc with the next numeral on it. With the gravity mode turned on, taps that are made by the child below the ‘shelf’ fall away, much in the same way that turning the page of a book makes that page number disappear. If one taps above the shelf, the yellow disc is ‘caught’ and remains on the shelf. It is thus possible to see just the yellow disc labelled ‘6’ on the shelf if the previous five taps have been below the shelf. Notice that this task requires being aware of the fact that 5 comes before 6, but does not require any sense of cardinality. In both the temporal dimensions, but also because of the lack of cardinal reference, this Enumerating World emphasises ordinality. With the use of the aural feedback, as well as the numerals, there is also a strong emphasis on language and symbol, as per Lyons’ recommendation (see Sinclair and Pimm 2015).

We draw upon this example of Sinclair and Coles from *TouchCounts* that points to the potential for ordinality in learning number (this volume, Sect. 9.3.5.3). In a kindergarten classroom, the children are sitting on the carpet, with the overhead projector hooked up to *TouchCounts*. The teacher has asked the children to count by 5s. They do this by tapping with four fingers (simultaneously) below the shelf and then once above. This leaves the multiples of 5 on the shelf. The children take turns doing the 4 + 1 tapping, but were asked to announce the number that would be on the shelf before starting tapping. Note that instead of hearing ‘five, ten, fifteen...’, the children hear ‘four, five, nine, ten, fourteen, fifteen...’.

The teacher had intended to only get up to about 25, but the children wanted to keep going. At 125, they began to predict what number would appear on the shelf – chanting it out, chorus style – and ended up going all the way to 200. At this point, the following interaction took place:

- Cam: I thought that two hundred was right after one hundred, but it’s not.
 Teacher: No, how far is it away from one hundred?
 Cam: It’s, it’s, it’s one more hundred away.

Significant in this episode is the fact that the children were involved in a skip-counting activity that had no explicit connection to a quantity of objects. Instead of seeing five objects as a cardinal quantity, they only saw the numbered object 5, as with all the multiples of 5. The attention was focused on the structure of the numbers, which is what enabled the children to begin to chant out the multiples. When the class reached 200, there had been no connection made between the number word and a quantity (of, say, two hundred objects). Indeed, Cam's realisation about the relation between 200 and 100 is not a cardinal one; he is instead basing his understanding of the relation on the observation that all the same multiples of 5 have to be done again in order to get from 100 to 200. In this sense, the relation seems to be deeply temporal, assembled as it is with the time it takes to create all the numbers up to 100 and then to 200. The relation is also entangled with *TouchCounts's* pronouncements ('one hundred', 'one hundred and forty-seven', 'two hundred'), some of which these children would never had heard before and which they could not have read from the symbolic forms (100, 147, 200), but could now begin to associate with those forms.

The discussion above suggests it is important to balance ordinal and cardinal aspects of number sense development in the primary grades. This will require some reflection on the ingrained ways in which cardinality is now privileged, as well as further creative explorations of how ordinality can be mobilised to promote the development of other number-related awareness such as place value.

7.4.2 *Part-Whole Relations and Structure Sense*

The Italian project (Baccaglioni-Frank and Scorza 2013; Baccaglioni-Frank and Bartolini Bussi 2015) builds upon a collaboration between cognitive psychologists and mathematics educators, aimed at developing teaching strategies for preventing and addressing early low achievement in arithmetic (also see papers by Young-Loveridge and Bicknell 2015, and Gervasoni and Parish (2015)). This project takes an innovative approach to the development of number sense, that is, being grounded on a kinaesthetic and visual-spatial approach to part-whole relationships.

The project focuses on the importance of perceiving part-whole relationships and of becoming aware of structure (Baccaglioni-Frank 2015; Electronic Supplementary Material: Baccaglioni-Frank, 2017a). This demonstrates that part-whole relations arise from what Resnick and colleagues (Resnick et al. 1991) have described as proto-quantitative part-whole schemas 'that organize children's knowledge about the ways in which material around them comes apart and goes together' (p. 32). For example, part-whole thinking helps students recognise that numbers are abstract units that can be partitioned and then recombined in different ways to facilitate numerical calculation (Britt and Irwin 2011). Moreover, part-whole thinking is fundamental for higher mathematical reasoning. For example, the pre-algebra literature highlights how if attention is drawn to the development of part-whole relations, no longer do 'addition and subtraction appear as separate operations, but

rather as dialectically interrelated actions that arise from the part-whole relation between quantities' (Schmittau 2011, p. 77).

Baccaglini-Frank (2015) refers to the part-whole relationship as a construct, highly resonant with the research on *awareness of mathematical pattern and structure* (AMPS) (Mulligan and Mitchelmore 2009, 2013). She refers to the critical feature of AMPS that is characterised by the child's structuring of groups to represent quantities; this involves part-whole relationships. Similarly, the ability to structure quantities is discussed in working group 5 (see Chap. 13) where the focus is on instruction that needs to provide opportunities for structural relationships to be associated with fundamental properties.

The following examples illustrate the use of hands and fingers to represent structure and the use of partitioning in the context of multiplication.

7.4.2.1 Hands and Fingers: An Important Embodied Structure

Various studies have highlighted how sensorimotor, perceptive and kinaesthetic-tactile experiences are fundamental for the formation of mathematical concepts – even highly abstract ones. For example, the key role attributed to the use of fingers in the development of number sense seems to be highly resonant with the frame of *embodied cognition*. Fingers and hands naturally embody part-whole relationships with respect to 5 and 10 and therefore can and should be used to foster such awareness. The didactical potential of hands and fingers in their natural positions can be exploited in many different ways (e.g. see Baccaglini-Frank 2015), including through multitouch technology, well before formal schooling starts (e.g. Baccaglini-Frank and Maracci 2015).

7.4.2.2 Use of Artefacts for Fostering the Development of Structure Sense: The Importance of Sharing Strategies

Various studies in mathematics education have focused on the design and implementation of didactical activities significantly based on bodily experience and on the manipulation of concrete objects with the aim of fostering the development of particular mathematical meanings. For example, in Chap. 9 (Sect. 9.2.1), within a semiotic perspective, Bartolini Bussi and colleagues describe how the student's use of specific artefacts in solving mathematical problems contributes to his/her development of mathematical meanings, in a potentially 'coherent' way with respect to the mathematical meanings aimed at in the teaching activity (Bartolini Bussi and Mariotti 2008). However, they argue that it is important to keep in mind that in fostering the development of mathematical meanings an essential component is the students' sharing, comparing and evolving of strategies (which can be accomplished in a number of different ways). These mathematical meanings, of course, can include structure sense, and this can be promoted through a variety of different mathematical content.

Fig. 7.3 A possible decomposition of 7×3 into $5 \times 3 + 2 \times 3$

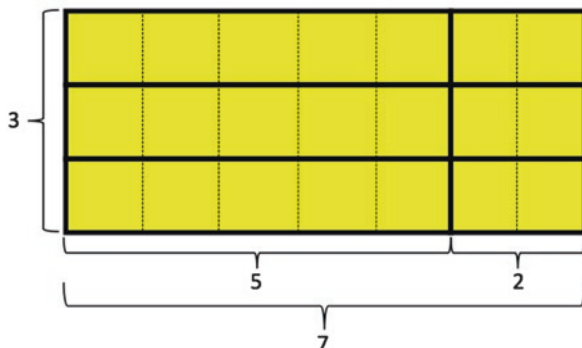

As an example, Baccaglioni-Frank (2015) shows how 7-year-old students learned to think about (and perform) products (up to 10×10) within the Italian *PerContare* project. The children were introduced to *rectangle diagrams*, cardboard rectangles with a grid of 1cm^2 squares marking its dimensions, which represent the numbers to be multiplied. The area of the rectangle (and its unit of measure) is the number of squares that make it up. Various activities with the rectangles are proposed with the didactical goal of fostering the students' production of visual and kinaesthetic-tactile manipulative strategies for calculating products using number facts they already know. Typically, students in the experimental second grade classes already knew the sequences of the first 10 multiples of 1 (from counting), 2 (they had learned to 'double'), 5 (they could quickly add 'hands') and 10 (they could quickly count up bundles of straws). So the activities aimed at developing strategies of decomposition and composition based on such knowledge. For example, to calculate 7×3 , children could think of 7 as $5 + 2$ and use the known rectangles 5×3 and 2×3 to build the total rectangle. Figure 7.3 shows an example.

The different strategies used by the children were compared and discussed. By the end of the school year, many children were able to perform calculations without the support of the physical rectangle diagrams any longer. For example, below is the verbal description produced by Marco (7 years 8 months) of the mental (and highly visual) strategy he uses to figure out 7×8 when he is called on by the teacher.

Teacher: Without drawing the 'building'² seven times eight, can you tell me how you break it and count it?

Marco: So, seven times eight... I break it into five and two, and I count it: five, ten, fifteen, twenty, twenty-five, thirty, thirty-five, forty... and I already have forty. Then I count the twos: two, four, six, eight, ten, twelve, fourteen, sixteen. Then I do forty plus, uh, I break the sixteen into ten and six, and I do forty plus ten, fifty, then I add those six and it is fifty-six.

Teacher: Wow! You are tremendous!

²In this class the teacher took on the class' idea to refer to the rectangle diagrams as (apartment) 'buildings' which could be split and put back together.

As he speaks, Marco frequently gazes into space, as if he were seeing the diagram he is decomposing and recomposing. Mulligan et al. (2013) refer to this as visualising the structure, a central component of AMPS.

The examples provided by Baccaglini-Frank (2015) turn our attention to the critical role of the structure of artefacts and the ways that young students interpret and construct representations. In the case of Marco, he has internalised the visualised 'structure' of the diagram, and we can infer that he had internalised the structure of the grid. The use of structure sense is embedded within this example. The ability to decompose or partition mathematical representations is directly linked to the child's strategies for calculating, often articulated by the child's strong visual imagery of buildings to be broken up and through verbalisation of 'I break... into parts'. The key process here is not counting by ones or repeated addition but structuring by partitioning or 'breaking up'. Some knowledge of base-ten structure is also evident here. Here we see similarities with the work of Young-Loveridge and Bicknell in their paper discussing the role of structure in terms of place value and grouping (working group 3, Chap. 9, this volume).

7.4.3 *Additive Relations*

The study by Roberts (2015) complements the work of Baccaglini-Frank (2015) pertaining to part-whole and structure sense. Roberts presented to working group 2 a conceptual framework for interpreting children's external representations of whole number additive relations in the early grades (Roberts 2015). She bases her approach on growing evidence from classroom studies in South Africa that one of the major factors inhibiting learners' mathematical progression is continued using of counting by ones strategies for mathematical calculations. This concern is not exclusive to studies with South African teachers and young children; for example, Young-Loveridge highlights the same concern in her studies from New Zealand reported in Chap. 13 (this volume).

Roberts explores young learners' representations of additive relationships and provides insights into underlying structure linked to grouping. She presents an adapted framework focusing on shifts within modes of representation that denote a move from counting to calculating. Based on the work of Ensor et al. (2009), she presents the adapted framework moving from concrete apparatus to iconic images, to indexical images (generic), to symbolic (number-based) and to the abstract symbolic-syntactical level. What the study suggests is that progression within these dimensions varies when various modes of representation are used for different tasks and at different times over the 10-day intervention period. What Roberts proposes is that it is important for teachers to attend to both structure (arrangement and group-wise) and action within a particular mode of representation, when interpreting learners' representations of additive relations.

Roberts' approach that articulates the need for children to work flexibly with multiple modes of representation is exemplified; particular representational types

are not automatically mapped to a particular calculation strategy. How the interplay of the various modes of representation interrelates with the developing sense of structure and the complexity of the structural features of the tasks at hand is exemplified. However, what we see here is the attempt to integrate complex aspects of structural development with more traditional, broad levels of progression from concrete to abstract thinking, as well as consideration of embodied action. What is difficult to assess is whether the structure dimensions direct or dominate the influence of other dimensions. There is clearly emphasis on the use of colinearity (left-right, top-bottom), linear directions and partitioning. This complex matrix approach raises relevant research questions about how the internalisation of the structural features occurs within and across the four dimensions over time and how this promotes abstraction and generalisation in developing arithmetic relationships such as equivalence or commutativity.

7.4.4 Cross-Cultural Study of Number Competence

Elia and van den Heuvel-Panhuizen investigated the number competence of kindergartners from the Netherlands ($n = 334$) and Cyprus ($n = 304$). The study supported the multidimensional nature of kindergartners' number development. Although the study did not include assessment items from the full domain of number and operations, four structures were found to be central to number competence: counting, subitising, additive and multiplicative reasoning. The children from the Netherlands outperformed those from Cyprus, demonstrating competence across the four components. The number competence of the children from Cyprus reflected two components, including extended counting and additive reasoning. The discussion focused on possible reasons for differences in competence where it was considered that the Cyprus kindergarten's mathematics curriculum and teaching practices may have been restricted to counting and additive reasoning and less attention was placed on subitising and multiplicative reasoning. Counting strategies may have dominated the Cyprus children's strategies. It was clear that young kindergarten children could solve multiplicative items and they connected multiplication and divisions processes, although the multiplicative items were the most difficult. This was consistent with other studies presented to working group 2.

Mulligan and colleagues reported similar findings to those of the Netherlands sample in their assessment of counting, subitising and multiplicative reasoning with kindergarten students from Australia using the interview-based Pattern and Structure Assessment (PASA). The possible over-reliance on counting was also described in the studies by Roberts and Milinković. Here we refer to the study of Gervasoni and Parish (2015), where they used individual interviews to assess over 2000 Australian primary-aged children from grades 1–4. Counting, place value, additive and multiplicative tasks were administered with gradual increase in competence, but an over-reliance on counting strategies even at grade 4 level was found. The working group 2 also questioned the limitations of some early number competency assessments

that may restrict items to counting and additive processes and argued for more assessments to probe mental calculation strategies.

7.4.5 Counting and Representations of Number

Milinković examined the development of young Serbian children's initial understanding of representations of whole numbers and counting strategies in a large cross-sectional study of 661 children aged 3–7 years. Individual interviews were conducted with a consistent set of 24 tasks across the sample so that developmental patterns in performance based on age categories could be ascertained. Although many of the tasks replicated a traditional approach, such as focusing on counting, set representation and one-to-one correspondence, there were some tasks that focused on structure through different spatial arrangements of groups of objects. Further there were tasks that required children to complete a two-dimensional drawing to show a quantity (box task) and to extend numbers on a number line that did not include equidistant points to assist in this process.

Although the research report is limited to performance data across the sample, there are some critical features inherent in some tasks that relate to other research discussed in working group 2. Milinković highlights the analysis of children's understanding of different graphical representations – the box diagram and number line – and presents some pertinent examples. Representations such as sets and the number line were found to be limited in their recordings. The ability to use equal spacing or a composite unit (equal size) to represent number appeared most difficult in the sequence of tasks developmentally.

7.5 Methodological Issues and Recommendations

In this section, we examine methodologies utilised in the type of studies on children's whole number learning and development being reviewed in this section. Evidently, these methodologies do not cover the whole range of research methods being used in the domain of WNA. Rather than providing a broad overview of the topic, we focus on two issues. First, we discuss study designs and their potentialities and limitations for understanding how children develop competencies with whole numbers. The discussion is restricted to cross-sectional, longitudinal and intervention studies. Second, we discuss task designs in cognitive neuroscience research pertinent to number learning. Here, we focus on the validity of tasks that are common to many studies measuring the understanding of magnitude of numbers. Such discussion reflects some of the issues raised in the previous ICMI Study 22 in 2014 (Watson and Ohtani 2015). To illustrate methodological issues, we refer to key aspects of whole number learning, such as strategy use, developmental aspects and

the effectiveness of instructional approaches. We conclude with some recommendations for further research on whole number learning.

7.5.1 *Study Designs*

7.5.1.1 **Assessing Strategy Use with Cross-Sectional Studies**

Whole number learning requires, among other things, learning increasingly advanced strategies. For example, young children might initially use counting strategies to solve addition tasks, but they might later use stepwise addition strategies or they might be able to retrieve the results from memory by retrieval of known number facts. Cross-sectional studies allow insights into children's performance and strategy use at a particular point in time. They also allow for investigation of how performance and strategy use depend on specific types of tasks and how performance and strategy use vary between students with different educational and socio-cultural backgrounds (e.g. He 2015; Ma et al. 2015; Milinković 2015; Verschaffel et al. 2015; Yang 2015). Chapter 3 on language aspects, Chap. 5 on reporting the discussion of working group 1 and the commentary paper by David Pimm (Chap. 4) each address the role of language and culture, also from a historical perspective in the development of whole number arithmetic. Here, we turn attention to the working group 1 discussion that shows how differences in number names according to culture may lead to wide differences in learning and pedagogical strategies.

An important issue in studying strategy use is the interplay between individual strategy use, individual ability and the affordances of a specific task. For example, children might not always use the most sophisticated strategy they could possibly use if less sophisticated strategies are more efficient for the specific task at hand. On the other hand, students might not be able to adapt their known strategy to the specific task. For that reason, researchers have argued that if in the assessment situation students are allowed to select their preferred strategy, we cannot draw valid conclusions concerning strategy efficiency (Siegler and Lemaire 1997). To draw such conclusions, it is necessary to compare students' performance in a choice condition wherein they are free to select their preferred strategy to their performance in a no-choice condition wherein students are forced to use a particular strategy. Many researchers have used this choice/no-choice method to study strategy efficiency and strategy flexibility (e.g. Verschaffel et al. 2015). This line of research has produced interesting and sometimes surprising results. For example, it seems that students do not always use the most efficient strategies that they may have acquired through instruction at school. Students also rely on strategies they have not been taught, and they might even invent their own strategies.

There is a rich and diverse range of studies that have examined strategy development and strategy use in early arithmetic development (e.g. see the papers by He on Chinese students' cognitive strategies to addition/subtraction problems (He 2015) and Yang on students' ability to judge the reasonableness of computational strate-

gies (Yang 2015)). Many studies on strategy use have also focused particularly on promoting numeracy programmes or frameworks. However, to date, the complex interplay between the factors that influence strategy use on WNA tasks is not fully understood.

An important limitation of cross-sectional studies is that they do not allow conclusions to be drawn with respect to individual development or causal relations to be determined between foundational or natural abilities and mathematical learning. For that purpose, we need longitudinal studies, intervention studies and those that track, possibly from the origins, the growth of individuals' strategy development in WNA.

7.5.1.2 Tracing Individual Development with Longitudinal Studies

Longitudinal studies rely on data from individual children assessed over a longer period of time. In the case of numerical development, such studies allow for identifying those variables assessed early in development that are most predictive of later arithmetic achievement. While longitudinal studies on arithmetic development have been relatively scarce until two decades ago, an increasing number of longitudinal studies have been carried out since (e.g. see the above-mentioned synthesis of research on early number sense by Sayers and Andrews 2015). Many of these studies have produced converging results. For example, several studies found that at pre-school age, counting and linking quantity to number words are important predictors of mathematical achievement in the first years of primary school (Aunio and Niemivirta 2010; Krajewski and Schneider 2009). Other researchers have combined several measures basic understanding of numbers with the concept of number sense. Number sense, measured at the beginning of schooling, predicted achievement in school mathematics in the first and third grades (Jordan et al. 2010). In a 6-year longitudinal study, Reeve, Reynolds, Humberstone and Butterworth (2012) clustered children at the age of 6 years according to their basic numerical abilities such as dot enumeration and number comparison. The authors found that the clusters were relatively stable over the period of the study and that membership to a cluster was a robust predictor of arithmetic ability 5 years later.

Although longitudinal studies have contributed to our understanding of how certain arithmetic abilities develop over time, most of these studies have focused strongly on cognitive variables related to mathematics while paying less attention to general cognitive variables (such as IQ and working memory) or environmental variables (such as school environment, classroom teaching or socio-economic variables) (but see Skwarchuk et al. 2014). From a mathematics education point of view, this is problematic, because these more distal variables might strongly influence children's development.

The benefit for mathematics education of identifying the most relevant early predictors of arithmetic competencies is that we can develop teaching approaches that specifically address these predictors. Yet, we need further research to evaluate whether the developed teaching approaches are actually effective and to identify the

most effective one(s) among competing teaching approaches. Intervention studies are suitable for that purpose.

7.5.1.3 Evaluating Teaching Approaches with Intervention Studies

Intervention studies have the advantage that, if properly designed, they allow conclusions about the causal effects of specific factors. This is at least the case when the intervention conditions are highly similar with respect to non-relevant factors. When designing an intervention study, an important question is how to design the control group condition. The challenge is that the question of what we want the experimental condition to be compared with to is not always obvious. Consider a game-based intervention study in which the experimental group uses a computer game that includes carefully designed number tasks. As a control condition, one might want to vary the method of instruction (computer-based versus not computer-based), the specific tasks (innovative tasks versus traditional tasks), the entertaining nature of instruction (game versus no game), the instructional setting (collaboration versus individual) or other factors. However, it is often impossible to vary all these factors within the same study. In addition, there might be theoretical reasons why combining certain factors is not reasonable from a mathematics education point of view. For example, collaborative learning might be more reasonable when the students work on problem-solving tasks than when they try to memorise arithmetic facts. Moreover, instructional factors are often closely related to one another, so that manipulating one factor can affect another factor.

Although strictly controlling the intervention conditions is necessary to draw conclusions about the causal effects of specific factors, doing so might reduce the external or ecological validity of the study. The reason is that the effectiveness of teaching approaches under controlled conditions might not transfer to regular, much more complex learning situations. Ideally, we need both highly controlled intervention studies and less strictly controlled classroom evaluation studies in order to compensate for the disadvantages of each. This will require replicating studies in a variety of settings and combining a variety of research methods (Schoenfeld 2007; Stokes 1997).

7.5.2 Task Designs

As discussed earlier in the first section of this chapter, neuroscience studies have addressed the brain mechanisms that underlie number processing. A main conclusion from this research field is that the human brain seems well prepared for processing (numerical) magnitudes. Although understanding number magnitudes has been a matter of research long before neuroscience studies identified the relevant brain areas, this conclusion increased the attention researchers paid to processing numerical magnitudes. Likewise, although the relation between mathematical

abilities and other cognitive abilities has been studied for a long time, the fact that the intraparietal sulcus is a brain region responsible for magnitude processing as well as spatial thinking has influenced a number of studies addressing the relationship between numerical and spatial abilities (e.g. Mulligan and Woolcott 2015).

Although there is no doubt that understanding numerical magnitudes is an important facet of whole number arithmetic abilities, its particular role for arithmetic development is not completely clarified yet. One reason among others is that the tasks (measures) that have been used in previous studies for assessing magnitude understanding may not be as valid as many have thought them to be. Most studies have used number comparison tasks or number line estimation tasks to assess magnitude understanding. In number comparison tasks, one has to decide which of two numbers is numerically larger. In number line estimation tasks, one has to place a given number in the correct position on an empty number line. Performance on both the number comparison task and the number line estimation task has proven to be highly predictive of mathematical learning (e.g. Booth and Siegler 2008). Many researchers have concluded that processing numerical magnitudes is essential for learning of numbers and they have used either task to assess magnitude understanding. Surprisingly, studies that addressed the relation between different measures challenged the assumption that these different measures rely on the same cognitive mechanisms. Studies documented that the correlation between performance on number comparison tasks and number line estimation tasks was very small (Sasanguie and Reynvoet 2013) and that performance on symbolic and non-symbolic number comparison tasks was virtually unrelated (Gilmore et al. 2011). Meanwhile, there is converging evidence that the association between number comparison and arithmetic competence is much stronger for symbolic than non-symbolic measures (Sasanguie et al. 2014; Schneider et al. 2017), suggesting that it is the proficient use of number symbols that has a strong association with arithmetic competence.

Recent studies question the assumption that number comparison and number line estimation are 'pure' measures of magnitude understanding. A possible explanation could be that depending on the specific numbers involved, these tasks can be solved by strategies that vary in how strongly they require magnitude understanding. For example, for comparing two-digit numbers, one can rely on digit-by-digit comparison without taking into account the magnitudes of the numbers as a whole. Likewise, researchers have argued that non-symbolic number comparison tasks may not only measure magnitude understanding as such, but also the capacity to suppress irrelevant visual cues (Clayton and Gilmore 2015) or to switch the focus on reliable cues (Gebuis and Reynvoet 2012). For number line estimation tasks, the strategies one can use also depend strongly on the specific numbers. Finding the correct position of 50 on a number line from 0 to 100 is easy (because finding the midpoint of the line is a visually simple task), while finding the correct position of 83 is more difficult, because there is no clear benchmark that can be used. Recent research has documented that already second grade children use a variety of strategies for solving number line estimation tasks and that these strategies depend on modes of presentations and the availability of benchmarks (Peeters et al. 2015).

More generally, most cognitive and neuroscience studies have used very simple tasks. For example, studies on the neural underpinnings of mental arithmetic have often used single-digit addition tasks. Although these are important first steps, and although performance of these tasks might be related to mathematical achievement later on, studying these tasks is not sufficient to explain mathematical thinking, which is typically much more complex. Accordingly, we should be cautious about interpreting neuroscience findings in terms of educational implications. In particular, we should not consider neuroscientific data as more convincing or informative than behavioural data (Beck 2010; De Smedt et al. 2011).

7.5.3 Conclusions: Methodological Issues

Some tentative conclusions and implications can be gleaned from the discussion provided in the above section. Studies that aim to provide predictive factors for math-related competencies may need to take into account the influence of a broader range of variables such as IQ, working memory and socio-contextual factors. The analyses of specific tasks such as number line estimation do not reflect the wide variation in children's own strategies that they may impose on the tasks. For example, the type and size of numbers may vary, but solutions may also depend on modes of presentation and the availability of benchmarks. Most cognitive and neuroscience studies have used very simple tasks limited to one area of competence. The limitations of these findings should be acknowledged in view of the much more complex relationships between concepts and processes that contribute to mathematics learning and thinking. Further, we need longitudinal studies to understand better how numerical abilities develop over time.

7.6 General Conclusions and Implications

7.6.1 General Conclusions

This chapter has highlighted the need to review neuro-cognitive, cognitive and developmental approaches to number learning and the measurement of numerical abilities. While critical components of WNA may differ between disciplines, some important commonalities have been found between approaches. Butterworth's research (2015) focused on the 'starter kit' for number also reflected conceptual foci on studies on early number from a cognitive mathematics education perspective. Tasks that incorporate subitising and numerical estimation are common to mathematics education psychological studies but differ methodologically. Although these neuro-cognitive studies provided convincing evidence of specific features of early

number development, these were limited to numerical magnitude and cardinality, assessed in clinical studies. Cognitive studies on early numerical and general mathematical competencies have received inadequate attention in the neuroscience field.

From various cognitive perspectives, key components and processes integral to mathematics learning and related to WNA were described: spatial reasoning and spatial sense, reasoning about quantities and relationships, SFON and SFOR, structural relations and patterns (AMPS), ordinality, partitioning and representing numerical relationships. These studies, together, provide evidence that young children are capable of quantitative reasoning from a young age. In particular, Sect. 7.3 highlighted recent research on young children's capacity to reason about quantitative relations (SFOR), as well as their *spontaneous tendency* to do so. This line of research shows strong synergies with the structural approach to early number development that focuses on awareness of mathematical patterns and structures (AMPS). In their conceptualisation of AMPS, Mulligan and Mitchelmore also go beyond the idea of early numerical competence based on ability. AMPS consists of two interdependent components: one cognitive (knowledge of structure) and one metacognitive (a tendency to seek and analyse patterns). It seems that reasoning about quantities and relationships, SFON and SFOR, structural relations and patterns (AMPS), ordinality, partitioning and representing numerical relationships are related to structural development in mathematics.

The exemplars of studies presented in Sect. 7.4 each reflect the need to take a more integrated approach to early WNA development. The studies point to a common approach that seeks to reveal the deep interconnected structural features of conceptual development of number. The studies of Baccaglioni-Frank and colleagues turn attention to the critical role of the structure of artefacts and the ways that young students interpret and construct representations. The use of structure sense is embedded within most examples. The ability to decompose or partition mathematical representations is also featured in the work of Milinković and colleagues. Several studies reflected that importance of varying models of representation supporting the idea of complexity of the learning process that is often absent from neat theoretical frameworks of likely learning progression. The discussion of methodological issues in Sect. 7.5 raises questions for future research and practice.

There were several papers in this working group which focused on learners with special needs: Butterworth (2015) drew attention to the prevalence and diagnosis of dyscalculia; Baccaglioni-Frank's paper (2015) reported on an intervention study in Italy designed to redirect Italian learners at risk of dyscalculia diagnosis; Gould's study (2015) focused on one child who used an atypical way of counting; and the Roberts (2015) paper was motivated by the prevalence of South African children aged 10–12 years using such inefficient unit counting strategies (long after this was developmentally appropriate). These papers depicted groups and individual children not progressing mathematically as expected in relation to their peers and/or the national mathematics curriculum. Issues concerning children with special learning needs are discussed further in Chap. 16.

7.6.2 *Implications for Further Research and Practice*

The chapter has highlighted three issues that lead to recommendations for further research. Firstly, we need longitudinal studies to better understand how numerical abilities develop over time. These studies should take into account not only math-related variables but also other variables that have crucial effects on development, such as IQ, working memory and contextual variables such as socio-economic factors and school environments. This would be helpful in putting the relevance of specific, math-related predictors into perspective. Although cross-sectional studies can hint at relevant relationships between specific sub-competencies, only longitudinal studies support conclusions about children's individual development and the causal relations between foundational math-related abilities and whole number arithmetic learnt at school.

Second, there is a need for intervention studies to develop evidence-based instructional tasks, tools and techniques. This would enhance educational practice and also contribute to our better understanding of the causal effects of arithmetic development. Combining both strictly controlled experimental studies and less strictly controlled field studies allows us to overcome the drawbacks of each (Schoenfeld 2007).

Third, we need more studies that systematically evaluate the validity of simple number tasks that have been used frequently in (neuro-)cognitive studies. A multi-method approach (as used in the study by Peeters et al. 2015) seems promising for that purpose. Once appropriate tasks and methods are available, future neuroscience studies could address more complex mathematical thinking.

A less (neuro-)psychologically dominated and more interdisciplinary approach might bring a broader, more balanced perspective that takes into account both empirically based and classroom-oriented research from cognitive and developmental views of WNA. Classroom intervention studies do not easily permit generalisation, nor do they reflect the highly controlled experimental settings of the neuro-cognitive studies, but these studies are critical to informing further research, mathematics teaching practice and curriculum development.

Several chapters in the volume have centred on teaching practices and tools for learning whole number arithmetic. For example, working group 3 (Chap. 9) discusses cultural artefacts and tasks and working group 4 (Chap. 11) teaching and assessment approaches. While this chapter has delved into the cognitive and neuro-cognitive bases of research related to concept development in number, there are clearly synergies between this chapter and teaching approaches.

Some important messages emanating from the working groups have been articulated for teachers so that they develop their professional knowledge and improved awareness of the complexities of whole number learning. Cognitive and neuro-cognitive approaches can enable new insights to be incorporated into teaching practices. Aligned with new insights is the need for effective professional learning programmes to enable teachers to implement and review new approaches, tasks or assessment practices that they adopt. Developing a better understanding of the wide variations in students' strategies and the difficulties students experience in acquisition of number concepts is critical to improving mathematics learning overall.

The research discussed in this chapter can provide to some extent explanations and possible interventions to assist teachers to focus on core mathematical foundations such as numerical magnitude representation and the mental number line, structures and relationships in developing number sense, promoting multiplicative thinking rather than restricting focus on counting and additive computations and attention to the role of spatial origins of number learning. The role of students' representations and interpretations of those representations has been exemplified. These examples may assist teachers in selecting appropriate representational tools and tasks to promote better understanding of whole number relationships. In conclusion this chapter has raised new questions from a range of perspectives, both neuro-cognitive and cognitive, but with a common goal of providing new insights into the complex and dynamic nature of young students' whole number learning.

References

- Aunio, P., & Niemivirta, M. (2010). Predicting children's mathematical performance in grade one by early numeracy. *Learning and Individual Differences*, 20, 427–435.
- Baccaglioni-Frank, A., & Bartolini Bussi, M. G. (2015). Buone pratiche didattiche per prevenire falsi positivi nelle diagnosi di discalculia: Il progetto PerContare. *Form@re-Open Journal per la formazione in rete*, 15(3), 170–184.
- Baccaglioni-Frank, A., & Maracci, M. (2015). Multi-touch technology and preschoolers' development of number-sense. *Digital Experiences in Mathematics Education*, 1(1), 7–27.
- Baccaglioni-Frank, A., & Scorza, M. (2013). Preventing learning difficulties in early arithmetic: The PerContare Project. In T. Ramiro-Sánchez & M. P. Bermúdez (Eds.), *Libro de Actas I Congreso Internacional de Ciencias de la Educación y des Desarrollo* (p. 341). Granada: Universidad de Granada.
- Baroody, A. J. (1999). Children's relational knowledge of addition and subtraction. *Cognition and Instruction*, 17(2), 137–175.
- Baroody, A. J., Torbeyns, J., & Verschaffel, L. (2009). Young children's understanding and application of subtraction-related principles. *Mathematical Thinking and Learning*, 11(1–2), 2–9.
- Bartolini Bussi, M. G., & Mariotti, M. A. (2008). Semiotic mediation in the mathematics classroom artefacts and signs after a Vygotskian perspective. In L. English (Ed.), *Handbook of international research in mathematics education* (2nd ed., pp. 746–783). New York: Routledge.
- Beck, D. M. (2010). The appeal of the brain in the popular press. *Perspectives on Psychological Science*, 5, 762–766.
- Booth, J. L., & Siegler, R. S. (2008). Numerical magnitude representations influence arithmetic learning. *Child Development*, 79, 1016–1031.
- Britt, M. S., & Irwin, K. C. (2011). Algebraic thinking with and without algebraic representation: A pathway for learning. In J. Cai & E. Knuth (Eds.), *Early algebraization: A global dialogue from multiple perspectives* (pp. 137–160). Berlin: Springer.
- Bryant, P., Christie, C., & Rendu, A. (1999). Children's understanding of the relation between addition and subtraction: Inversion, identity and decomposition. *Journal of Experimental Child Psychology*, 74, 194–212.
- Butterworth, B. (2005). The development of arithmetical abilities. *Journal of Child Psychology and Psychiatry*, 46(1), 3–18.
- Butterworth, B., & Reeve, R. (2008). Verbal counting and spatial strategies in numerical tasks: Evidence from indigenous Australia. *Philosophical Psychology*, 21, 443–457.
- Clayton, S., & Gilmore, C. (2015). Inhibition in dot comparison tasks. *ZDM Mathematics Education*, 47(5), 759–770.

- Clements, D. H., & Sarama, J. (2011). *Tools for early assessment in math (TEAM). Teacher's Guide*. Columbus: McGraw-Hill Education Series.
- Coles, A. (2014). Ordinality, neuro-science and the early learning of number. In P. Liljedahl, C. Nicol, S. Oesterle, & D. Allan (Eds.), *Proceedings of the Thirty-eighth annual conference of the International Group for the Psychology of Mathematics Education* (Vol. 2, pp. 329–336). Vancouver: PME.
- De Smedt, B., Ansari, D., Grabner, R. H., Hannula-Sormunen, M., Schneider, M., & Verschaffel, L. (2011). Cognitive neuroscience meets mathematics education: It takes two to tango. *Educational Research Review*, 6, 232–237.
- Dehaene, S. (2011). *The number sense: How the mind creates mathematics*. New York: Oxford University Press.
- Dehaene, S., Piazza, M., Pinel, P., & Cohen, L. (2003). Three parietal circuits for number processing. *Cognitive Neuropsychology*, 20, 487–506.
- Dowker, A. (2008). Individual differences in numerical abilities in preschoolers. *Developmental Science*, 11, 650–654.
- Ensor, P., Hoadley, U., Jacklin, H., Kuhn, C., Schnitte, E., Lombard, A., & van den Heuvel-Panhuizen, M. (2009). Specialising pedagogical text and time in Foundation Phase numeracy classrooms. *Journal of Education*, 47, 5–30.
- Fuson, K. C. (1988). *Children's counting and concepts of number*. New York: Springer-Verlag.
- Gattegno, C. (1974). *The common sense of teaching mathematics*. New York: Educational Solutions Worldwide Inc..
- Geary, D. C., Bow-Thomas, C. C., & Yao, Y. (1992). Counting knowledge and skill in cognitive addition: A comparison of normal and mathematically disabled children. *Journal of Experimental Child Psychology*, 54, 372–391.
- Gebuis, T., & Reynvoet, B. (2012). The interplay between nonsymbolic number and its continuous visual properties. *Journal of Experimental Psychology: General*, 14, 642–648.
- Gilmore, C., & Bryant, P. (2006). Individual differences in children's understanding of inversion and arithmetical skill. *British Journal of Educational Psychology*, 76, 309–331.
- Gilmore, C., Attridge, N., & Inglis, M. (2011). Measuring the approximate number system. *Quarterly Journal of Experimental Psychology*, 64, 2099–2109.
- Göbel, S. M., Watson, S. E., Lervåg, A., & Hulme, C. (2014). Children's arithmetic development: It is number knowledge, not the approximate number sense, that counts. *Psychological Science*, 25(3), 789–798.
- Griffin, S. (2004). Teaching number sense. *Educational Leadership*, 61(5), 39–42.
- Hannula, M. M., & Lehtinen, E. (2005). Spontaneous focusing on numerosity and mathematical skills of young children. *Learning and Instruction*, 15(3), 237–256.
- Jordan, N. C., Glutting, J., & Ramineni, C. (2010). The importance of number sense to mathematics achievement in first and third grades. *Learning and Individual Differences*, 20, 82–88.
- Krajewski, K., & Schneider, W. (2009). Early development of quantity to number-word linkage as a precursor of mathematical school achievement and mathematical difficulties: Findings from a four-year longitudinal study. *Learning and Instruction*, 19(6), 513–526.
- Lyons, I., & Beilock, S. (2011). Numerical ordering ability mediates the relation between number-sense and arithmetic competence. *Cognition*, 121(2), 256–261.
- McMullen, J., Hannula-Sormunen, M. M., & Lehtinen, E. (2013). Young children's recognition of quantitative relations in mathematically unspecified settings. *Journal of Mathematical Behavior*, 32, 450–460.
- McMullen, J., Hannula-Sormunen, M. M., & Lehtinen, E. (2014). Spontaneous focusing on quantitative relations in the development of children's fraction knowledge. *Cognition and Instruction*, 32(2), 198–218.

- Mulligan, J. T., & Mitchelmore, M. C. (2009). Awareness of pattern and structure in early mathematical development. *Mathematics Education Research Journal*, 21(2), 33–49.
- Mulligan, J. T., & Mitchelmore, M. C. (2013). Early awareness of mathematical pattern and structure. In L. English & J. Mulligan (Eds.), *Reconceptualizing early mathematics learning* (pp. 29–46). Dordrecht: Springer.
- Mulligan, J. T., Mitchelmore, M. C., English, L., & Crevensten, N. (2013). Reconceptualizing early mathematics learning: The fundamental role of pattern and structure. In L. English & J. Mulligan (Eds.), *Reconceptualizing early mathematics learning* (pp. 47–66). Dordrecht: Springer.
- Mulligan, J. T., Mitchelmore, M. C., & Stephanou, A. (2015). *Pattern and Structure Assessment (PASA): An assessment program for early mathematics (Years F–2) teacher guide*. Melbourne: ACER Press.
- Nunes, T., Bryant, P., Burman, D., Bell, D., Evans, D., & Hallett, D. (2008). Deaf children's informal knowledge of multiplicative reasoning. *Journal of Deaf Studies and Deaf Education*, 14, 260–277.
- Nunes, T., Bryant, P., Barros, R., & Sylva, K. (2012). The relative importance of two different mathematical abilities to mathematical achievement. *British Journal of Educational Psychology*, 82, 136–156.
- Peeters, D., Degrande, T., Ebersbach, M., Verschaffel, L., & Luwel, K. (2015). Children's use of number line estimation strategies. *European Journal of Psychology of Education*. (Online first) doi:<https://doi.org/10.1007/s10212-015-0251-z>
- Peters, G., De Smedt, B., Torbeyns, J., Ghesquière, P., & Verschaffel, L. (2010). Using addition to solve subtractions in the number domain up to 20. *Acta Psychologica*, 133, 163–169.
- Piaget, J., & Szeminska, A. (1952). *The child's conception of number*. London: Routledge. (Original work published 1941).
- Reeve, R., Reynolds, F., Humberstone, J., & Butterworth, B. (2012). Stability and change in markers of core numerical competencies. *Journal of Experimental Psychology: General*, 141, 649–666.
- Resnick, L. B., Bill, V. L., Lesgold, S. B., & Leer, N. M. (1991). Thinking in arithmetic class. In B. Means, C. Chelemer, & M. S. Knapp (Eds.), *Teaching advanced skills to at-risk students* (pp. 27–53). San Francisco: Jossey-Bass.
- Robinson, K. M., Ninowski, L. E., & Gray, M. L. (2006). Children's understanding of the arithmetic concepts of inversion and associativity. *Journal of Experimental Child Psychology*, 94, 349–362.
- Rubinsten, O., & Henik, A. (2005). Automatic activation of internal magnitudes: A study of developmental dyscalculia. *Neuropsychology*, 19, 641–648.
- Sasanguie, D., & Reynvoet, B. (2013). Number comparison and number line estimation rely on different mechanisms. *Psychologica Belgica*, 53, 17–35.
- Sasanguie, D., Defever, E., Maertens, B., & Reynvoet, B. (2014). The approximate number system is not predictive for symbolic number processing in kindergarteners. *The Quarterly Journal of Experimental Psychology*, 67, 271–280.
- Schleifer, P., & Landerl, K. (2011). Subitizing and counting in typical and atypical development. *Developmental Science*, 14, 280–291.
- Schmittau, J. (2011). The role of theoretical analysis in developing algebraic thinking: A Vygotskian perspective. In J. Cai & E. Knuth (Eds.), *Early algebraization: A global dialogue from multiple perspectives* (pp. 71–86). Berlin: Springer.
- Schneider, M., Beeres, K., Coban, L., Merz, S., Schmidt, S. S., Stricker, J., & De Smedt, B. (2017). Associations of non-symbolic and symbolic numerical magnitude processing with mathematical competence: A meta-analysis. *Developmental Science*, 20(3), p. 16.
- Schoenfeld, A. H. (2007). Method. In F. K. Lester (Ed.), *Second handbook of research on mathematics teaching and learning* (pp. 69–107). Charlotte: Information Age Publishing.

- Siegler, R. S., & Booth, J. L. (2004). Development of numerical estimation in young children. *Child Development*, 75, 428–444.
- Siegler, R. S., & Lemaire, P. (1997). Older and younger adults' strategy choices in multiplication: Testing predictions of ASCM using the choice/no-choice method. *Journal of Experimental Psychology: General*, 126, 71–92.
- Sinclair, N., & Jackiw, N. (2011). *TouchCounts*. Application for the iPad. <https://itunes.apple.com/ca/app/touchcounts/id897302197?mt=8??>
- Sinclair, N., & Pimm, D. (2015). Whatever be their number: Counting on the visible, the audible, and the tangible. In M. Meletiou-Mavrotheris, K. Mavrou, & E. Paparistodemou (Eds.), *Integrating touch-enabled and mobile devices into contemporary mathematics education* (pp. 50–80). Hershey: IGI Global.
- Skwarchuk, S. L., Sowinski, C., & LeFevre, J. A. (2014). Formal and informal home learning activities in relation to children's early numeracy and literacy skills: The development of a home numeracy model. *Journal of Experimental Child Psychology*, 121, 63–84.
- Stokes, D. E. (1997). *Pasteur's quadrant: Basic science and technical innovation*. Washington, DC: Brookings.
- Watson, A., & Ohtani, M. (2015). *Task design in mathematics education: The 22nd ICMI Study*. New York: Springer.

Cited papers from Sun, X., Kaur, B., & Novotna, J. (Eds.). (2015). Conference proceedings of the ICMI study 23: Primary mathematics study on whole numbers. Retrieved February 10, 2016, from www.umac.mo/fed/ICMI23/doc/Proceedings_ICMI_STUDY_23_final.pdf

- Baccaglioni-Frank, A. (2015). Preventing low achievement in arithmetic through the didactical materials of the PerContare project (pp. 169–176).
- Butterworth, B. (2015). Low numeracy: From brain to education (pp. 21–33).
- Elia, I., & van den Heuvel-Panhuizen, M. (2015). Mapping kindergartners' number competence (pp. 177–185).
- Gervasoni, A., & Parish, L. (2015). Insights and implications about the whole number knowledge of grade 1 to grade 4 children (pp. 440–447).
- Gould, P. (2015). Recalling a number line to identify numerals (pp. 186–193).
- He, S. (2015). How do Chinese students solve addition/subtraction problems: A review of cognitive strategy (pp. 194–202).
- Ma, Y., Xie, S., & Wang, Y. (2015). Analysis of students' systematic errors and teaching strategies for 3-digit multiplication (pp. 203–211).
- Milinković, J. (2015). Counting strategies and system of natural number representations in young children (pp. 212–219).
- Mulligan, J., & Woolcott, G. (2015). What lies beneath? Conceptual connectivity underlying whole number arithmetic (pp. 220–228).
- Obersteiner, A., Moll, G., Reiss, K., & Pant, H. A. (2015). Whole number arithmetic: Competency models and individual development (pp. 245–250).
- Roberts, N. (2015). Interpreting children's representations of whole number additive relations in the early grades (pp. 245–250).
- Sayers, J., & Andrews, P. (2015). Foundational number sense: The basis for whole number arithmetic competence (pp. 124–131).
- Sinclair, N., & Coles, A. (2015). 'A trillion is after one hundred': Early number and the development of symbolic awareness (pp. 251–259).

- Verschaffel, L., Torbeyns, J., Peters, G., De Smedt, B., & Ghesquière, P. (2015). Analysing subtraction-by-addition in the number domain 20–100 by means of verbal protocol vs reaction time data (pp. 260–267).
- Yang, D-C. (2015). Performance of fourth graders in judging reasonableness of computational results for whole numbers (pp. 268–276).
- Young-Loveridge, J., & Bicknell, B. (2015). Using multiplication and division contexts to build place-value understanding (pp. 379–387).

Open Access This chapter is licensed under the terms of the Creative Commons Attribution 4.0 International License (<http://creativecommons.org/licenses/by/4.0/>), which permits use, sharing, adaptation, distribution and reproduction in any medium or format, as long as you give appropriate credit to the original author(s) and the source, provide a link to the Creative Commons license and indicate if changes were made.

The images or other third party material in this chapter are included in the chapter's Creative Commons license, unless indicated otherwise in a credit line to the material. If material is not included in the chapter's Creative Commons license and your intended use is not permitted by statutory regulation or exceeds the permitted use, you will need to obtain permission directly from the copyright holder.



Chapter 8

Whole Number Thinking, Learning and Development: A Commentary on Chapter 7



Pearla Nesher 

8.1 Introduction

The previous chapter titled *Whole number thinking, learning and development* embraces many theoretical issues that enrich our understanding of the early attainment of arithmetic skills, followed by a description of concrete applications that teachers can implement in the classroom. I would like to focus this commentary on two issues: (a) cardinal and ordinal numbers and (b) patterns and structure. Additionally, I will add some comments that go beyond the scope of the chapter, but are relevant to the study of whole numbers and their operations at the early stages of arithmetic learning.

8.2 Cardinal and Ordinal Numbers

8.2.1 *Philosophical Musings*

Sinclair and Coles (2015) challenge current emphases on *cardinal* awareness in learning number and suggest focusing on the development of ordinality. Their hypothesis states that what is significant in the learning of number (and more generally in mathematics) is not being able to link symbols to objects but being able to link symbols to other symbols. They also challenge the emphasis that is put on linking number symbols to collections of objects (i.e. on cardinality) in the first years of schooling. I will discuss these points from two perspectives: the philosophical point of view and the child development point of view.

P. Nesher (✉)

Professor of Math Education, University of Haifa, Haifa, Israel

e-mail: nesherp@edu.haifa.ac.il

© The Author(s) 2018

M.G. Bartolini Bussi, X.H. Sun (eds.), *Building the Foundation: Whole Numbers in the Primary Grades*, New ICMI Study Series, https://doi.org/10.1007/978-3-319-63555-2_8

169

From a philosophical point of view, cardinality is based on sets and the basic concept involved is the ‘one-to-one correspondence’ (Fraenkel 1942). The limitation of this approach is that it signifies that the sets are equal in number but does not specify the number of items in a set (Russell 1919). The exact number of a set is based on counting, which is based on order (this will be elaborated on later).

The basis for numbers from an *ordinal* point of view was made by Peano (in Russell 1919) who suggested three primitive notions: ‘0’, ‘number’ and ‘successor’ along with five axioms:

0 is a number.

The successor of any number is a number.

No two numbers have the same successor.

0 is not the successor of any number.

Any property which belongs to 0, and also to the successor of every number which has the property, belongs to all numbers. (Russell 1919/1971, p. 5)

However, as Russell (1919) wrote, these axioms can serve for any progression and not rather for the series of natural numbers. This leads me to elaborate on another important point made by Sinclair and Coles (2015):

There is an intriguing parallel, however, between our hypothesis and the (perhaps neglected) work of Gattegno (1961) and Davydov (1975) both of whose curriculum for early number were based on developing awareness of relations between lengths (Dougherty 2008), where what are symbolized are relations between objects (greater than, less than, double, half), rather than, say, using numerals to label ‘how many’ objects are in a collection. (Sinclair and Coles 2015, p. 253)

Bearing in mind Russell’s comment, we can notice that Gattegno (1961) and his use of *Cuisenaire rods* (this volume Sects. 9.3.1.1 and 10.3.3) provides an analogy to Peano’s axioms (Neshet 1972). Cuisenaire rods are a didactic tool consisting of coloured rods in which the difference in lengths of two consecutive rods is exactly the length of the white rod (the unit rod). The children recognise these rods by colour. If we let ‘the white’, ‘a rod’ and the ‘follower in length’ be the primitive concepts, then the analogous reading of Peano’s axioms will be as follows:

1. ‘The white’ is ‘a rod’.
2. The ‘follower in length’ of any rod is ‘a rod’.
3. No two rods have the same ‘follower in length’.
4. ‘The white’ is not a ‘follower in length’ of any rod.
5. Any property that belongs to ‘the white’ and also to the ‘follower in length’ of every rod that has the property belongs to all the rods.

Of course, one does not teach these axioms to children, yet noticing the isomorphism between the Cuisenaire rods and the axioms of natural numbers guarantees that all properties of natural numbers can be demonstrated accurately with tangible objects.

Cuisenaire rods have an additional important property. Going back to philosophy, it was Frege (1884/1980) who elaborated on the definition of ‘number’ and came to the conclusion that ‘number’ in general is a concept, and individual numbers (such as ‘4’, ‘9’, etc.) are singular *objects* falling under this concept. It is hard

to visualise that the meaning of the number '4' is an *object* and that it does not represent a set four objects. However, as a mathematical object, the number '4' represents the set of all sets of four objects (Russell 1919).

It might be interesting to note that in natural language (in English, as well as in many other languages, including Hebrew) one says '4 *is* an even number' and not '4 *are* an even number', which conveys the notion of a singular object. We often hear in natural language, as well as in word problems in mathematics, expressions such as '4 apples *are* on the table'. However, here the number 4 is employed as a *quantifier* to the subject of the sentence which is the apples, while in the sentence '4 is an even number', '4' is in the nominative position and refers to a mathematical object.

8.2.2 A Note About Number and Counting

The development of counting is inherently dependent on the advancement through various levels, for example, having a stable list of number names and the ability to tag objects of a set by the 'one-to-one correspondence' abilities that are culminated by the process of encapsulation at the notion of a number as an *object* of mathematics. By fully completing this process, the child is ready to perform symbolically mathematical operations and master more complex mathematical concepts.

Thus, the difficulties of the early stages of arithmetic learning lie not in teaching too many cardinal aspects of number, but rather in the fact that we sometimes confuse *counting* with cardinal number. Mathematics literature is full of examples in which the child counts ('all' the entities in two collections or 'on', starting from the number of entities in the first collection and going on with the second collection) and describes it as if it was an addition operation, while it is actually a continuation of counting. The use of the '+' sign among numbers (i.e. $5 + 3$) symbolises the mathematical operation of addition with numbers which are themselves objects of mathematics. We frequently observe children who are given a symbolic exercise such as ' $5 + 3$ ' and solve it by counting. Some explain: 'they have not yet mastered 'number facts''. I would like to suggest that they have not yet made the encapsulation of number as a mathematical object and have not learned the real mathematical interpretation of the symbols in the 'additive structure' as being something different in principle from counting, to which I will refer in the next section.

Learning mathematics is a long process and is achieved in an individual manner. I do not suggest forcing those who have not yet progressed beyond counting to jump ahead. However, I think that teachers should be aware of the difference between counting and the cardinal number as an object of mathematics. Saying that the last number in counting is the cardinal number is half of the story; splitting the cardinal number from counting and encapsulating it into a mathematical object is the one-step jump into mathematics. This is, of course, resonant with Piaget's (1941/1965) notion of number and addition becoming operational:

It is operations that are the essence of thought, and it is of the nature of operations continuously to construct something new. Thus, if $1 + 1 + 1 = 3$, the three units that are added are identical with three in the sense that the total three can again give, by enumeration, the three units identical with the original three, *but the additive operation has created a new entity, the totality three* [italics added]. (p. 202)

Without intending to trouble kids or people who are not interested in the philosophical grounds of number (or linguistics), it is good to know that each of the Cuisenaire rods is a *tangible continuous object*, one that masks *counting* (though enables counting by measuring the length of each rod by units), and can help in this transition. Since young children use concrete materials for exemplification, it is advantageous that there are such materials, as recommended by Sinclair and Coles (2015), which enable the child who already counts reliably to relate to numbers as mathematical objects.

8.2.3 Psychological Considerations

Mounds of psychological and neuroscience research in the last 20 years were devoted to the question of whether the count-based representation of the natural numbers is the work of evolution or that of human culture (Butterworth 2005, 2015; Dehaene 1997; Feigenson et al. 2004). While all agree on the core capacity for numerical processing (e.g. subitising – this volume Sect. 7.2.1., representing non-symbolic numerical magnitudes, etc.), there are theoretical disagreements as to whether these core endowments with which young children (babies and toddlers) are equipped are analogue in nature (Dehaene 1997) or characterised by a distinction of object files as evident by subitising (Carey 2004; Le Corre and Carey 2007).

While Dehaene, Piazza, Pinel and Cohen (2003) in their neuroscience studies map regions in the brain to three distinct numerical capabilities (i.e. a visual Arabic mode, an analogical magnitude code and a verbal code), Le Corre and Carey (2007) examine young children's first experiences in counting and trace its progression. Though their experiments examined mainly cardinality, they point to the ordinal development of number concepts.

Before attending to Carey's (2004) theory, let us recall Piaget's (1941/1965) seminal work, *The child's conception of number*, in which after delving into detailed levels of seriation and cardinality, and after elaborating on the nature of symmetrical relations that form classes (hence, cardinality) and the asymmetric relation of order that forms ordinality, he writes:

There is then no doubt as to the explanation of the coordination between ordinal and cardinal numbers...Finite numbers are therefore necessarily at the same time cardinal and ordinal, since it is the nature of number to be both a system of classes and of asymmetrical relations blended into one operational whole. (p. 157, Piaget 1965 edition)

Returning to Carey (2004), most researchers agree upon the range of subitising (quantities of one to three or four) in which the comprehension of a set's quantity is

fast and seems to be performed perceptually without counting. Carey, who studied the emergence of cardinal numbers, describes the process of very young children who when asked to give one item give the one object but when asked to give two will give any bunch of objects. She names them ‘one-knowers’. Six months later, they can distinguish ‘one’ and ‘two’ (these she calls ‘two-knowers’; they give exactly two objects, but fail for the exact amounts of other number names). Carey suggests that the within this range, children learn the numbers the way they learn the meaning (the extension) of other quantifiers such as ‘many’ and ‘all’ in natural language, and numbers beyond this range are taken as ‘many’. This, according to her theory, changes for greater cardinals such as 7 or 12 (Carey 2004; Nesher 1988).

Carey (2004) suggests that in the meantime the child learns the list of counting words that initially has no meaning to it and is recited as a ritual. Fuson and Hall (1983) have described in detail the process of learning how to count. She describes how the child progresses in mastering the order of the numerals. At each stage, the child acquires some knowledge about numbers that comprises a stable ordered list, followed by numbers recited in the right order, but with skips. Then, from not knowing the right order or missing larger number names, the child starts to repeat the previous known number names. These stages are of course dynamic and the ranges of stable lists grow with age and experience. Similarly, Gelman and Gallistel (1978) have described the principles underlying counting including a stable ordered list of number names, the one-to-one principle of attaching the number words as tags to every counted object (without repeating or omitting objects), that the order of counting objects is not important and comprehending that the last counted number name is the cardinal number of the counted set.

However, Carey suggests that the knowledge of the *stable ordered* list of number words in natural language is the key for learning the concept of a *successor*. The successor principle, operationalised as the knowledge that adding one object to a set (i.e. n) results in an increase of exactly one unit on the count list (i.e. $n + 1$). It is this knowledge that enables coordination between the ordered list of words and the sets to be enumerated, in order to establish their cardinal number.

It should be noted that the stable string of number words holds an asymmetrical relation between the words and necessarily fosters ordinality in counting the sets. This occurs according to researchers such as Fuson and Hall (1983) and Gelman and Gallistel (1978) before the child acquires cardinality. As soon as the child succeeds in tagging the sets correctly (i.e. mastering one-to-one correspondence between the ordered words and the objects), he is already in the mode of ordinality, which is embedded in the notion of cardinality.

In sum, though Sinclair and Coles (2015) are saying ‘it is important to balance ordinal and cardinal aspects of number sense development in the primary grades’, it seems that they call more attention to the aspect of patterns in mathematics and overlook the aspect of *structure* and as a result also missed a central aspect of Gattegno’s (1962) work with the Cuisenaire rods.

8.3 Structure

8.3.1 *Structure in Mathematics*

Structure refers to the way in which the various elements are organised and related, and to the essence of operations between numbers. In starting the section on structure (this volume Sect. 7.3.3), the author mentions additive principles such as commutativity ($a + b = b + a$) and the addition-subtraction inverse ($a + b - b = a$). These principles and others are derived from the structure of additive relations as stressed by many researchers (e.g. Mulligan and Mitchelmore 2009; Neshet 1989; Roberts 2015; Schmittau 2011; Vergnaud 1982). The notion of structures is central in mathematics and is stressed in higher education (e.g. in learning about groups, fields, rings). The interest in structure in primary grades has had its revival recently with the attempts to teach pre-algebra as early as possible (see Cai and Knuth 2005; see also this volume Chaps. 13 and 14).

This brought attention back to Davydov's (1975) work. Davydov's (1975) approach starts with quantities symbolised in lengths and derives the notion of number from a unit of measurement. Children use letters to express the relationships between quantities, learn to express part-whole relationships between quantities, transform inequalities into equalities and find missing wholes and parts using addition and subtraction. The relation of the whole-part additive structure is presented before numbers.

A similar approach is taken by Gattegno (1962) who used the coloured rods to probe the additive structure. Like Davydov (1975), who uses letters before numbers, Gattegno employs colours to distinguish between lengths. And since the set of rods up to ten are constructed under the idea of 'successor in length' (which forms monotonic steps for the child), the rods serve as a concrete apparatus that can be easily manipulated and is isomorphic to the numbers yet emphasises first structures and relations.

Let us consider the following exemplification suggested by Gattegno (Gattegno 1971 and Fig. 8.1): Putting rods 'end to end' will exemplify addition and the symbol '+' (see A in the drawing), putting rods 'side by side' (B) will exemplify subtraction and will be symbolised by the '-' sign, and finally, completing the structure to two equal lengths of rows (C) will justify the '=' sign.

Thus, the sentence ' $A + B = C$ ' has a full concrete analogy, and the child can absorb that symbols such as '+', '-', and '=' have a distinct, though currently limited, meaning within a structure. This structure will be elaborated on and enriched in the future. The alternation between instructions in natural language, well understood by the child (e.g. 'end to end', 'equal lengths', etc.), exemplification by concrete materials and introducing the symbolic signs of arithmetic as analogy to these structures supports the learning of the language of arithmetic. In a way, the above exemplification of the additive structure of the rods represents the semantics of the signs '+', '-', and '=' (to be discussed in the next section).

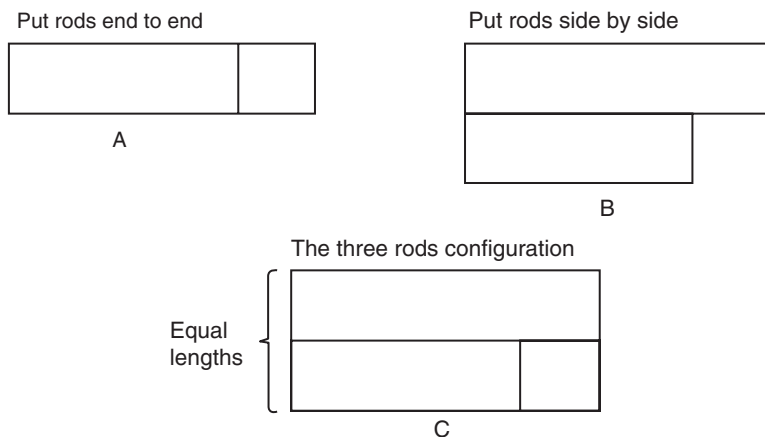

The exemplification of the additive relation.

Fig. 8.1 Example elaborated by the author: exemplification according to Gattegno's approach to the additive relation (See Gattegno 1971, p. 24.) (Note: This is a simplified version of the original figure.)

8.3.2 School Practice

This approach is entirely different from the practice in many schools. Recently, Bruun, Diaz, and Dykes (2015) suggested teaching the language of mathematics and the meaning of the arithmetic operations in a detached manner. The children in their classes learn to define mathematical words and give an example and a non-example. So, for instance, the following definition of addition is given: 'A mathematical operation in which the sum of two numbers or more is calculated, usually a plus sign (+)'. A non-example is given: ' $9 - 3$ ' (p. 532). Then, the following definition of subtraction is given: 'The operation or process of finding the difference between two numbers using the (-) minus sign'. A non-example is given: ' $2 + 2$ '. (p. 533).

Instead of teaching the full structure of the additive relations, the '+' and the '-' operations are not connected and even stand as negative examples. What then might a student do with an open sentence such as: ' $3 + \quad = 9$ '? Is it 'addition' or 'subtraction'? In fact, answering this question by adding $3 + 9$ and replying 12 is a most common error performed by children – clear evidence of the misunderstanding of the additive structure and the full meaning of '+' and '-'. Many children also interpret the '=' sign as a non-symmetric command: 'do it' rather than a symmetric sign of equivalence.

The Cuisenaire rods are by no means the only tool that can be used to acquire the semantics of the mathematical signs. One can develop manipulative materials with discrete models of numbers such as grids of rectangles or sets of circles or a number line as well.

For example, let's consider the approach proposed by Carraher and Schliemann (2015). They suggest, and even experimented with, learning pre-algebra in third to fifth grade. They consider the four operations learned as functions and suggest approaching '+ 3' as a function that can be employed in open sentences such as ' $n + 3$ ', where ' n ' can receive any number. Carraher and Schliemann claim that this approach enables children to integrate arithmetic with algebra and geometry. The major concrete exemplification they employ is the number line, though they've tried their ideas in other contexts such as a box of candies or heights. This approach, too, departs from counting and relates, like Davydov (1975), to numbers as units of measurements. Their interpretation of the '+' sign is as a one-argument function of 'adding' or 'advancing', and the '=' sign is the comparison of two functions (Carraher and Schliemann 2015).

8.3.3 Concrete Materials

I would like to emphasise that it is not sufficient to introduce concrete materials that represent *numbers*, but rather, a sound pedagogy needs to support the learning of the semantics of the mathematical signs such as '+', '-' and '=', because these signs have semantics and knowing them means *understanding* the relevant structure. By the semantics in early arithmetic learning I mean the following.

In addition to the concrete materials, numbers on the two sides of the '+' sign refer to the parts (named 'addends'), and the number after the '=' sign refers to the equivalent whole amount (the 'sum'). In subtraction, the role of the numbers differs. The number to the left of the '-' sign refers to the sum, and the number to the right of the '-' sign is one of the addends. The number to right of the '=' sign in subtraction refers to the second addend. However, both '+' and '-' refer to the same underlying structure.

The rods' additive construction with its language game offers even young children a microworld (or a model) that implements relations such as parts and whole similar to the semantics of the mathematical additive structure of natural numbers. A child who works according to the rules of the exemplification can realise a temporary meaning of the symbols '+', '-' and '=', and for him or for her, a string of symbols such as ' $3 = 4 + =$ ' is meaningless. All the relations mentioned in Chap. 7 (this volume), such as commutativity ($a + b = b + a$) and the addition-subtraction inverse ($a + b - b = a$), also ($c > a$) and ($b < a$) from Davydov (1975), etc. are visible in the model and can be understood.

8.4 Final Remarks

To sum up, one should be aware that shifting from counting, which is learned within natural language, and acting within the arithmetical discipline is an enormous step for the child and its difficulty is not fully appreciated.

Sometimes the child adds or subtracts correctly by non-arithmetical means such as counting, and we mistakenly regard it as if he or she understands the ‘+’ operation of arithmetic. The ‘+’ operation is between numbers, and as long as the child did not grasp the cardinal numbers, he or she essentially did not learn the meaning of the ‘+’ sign, which gets its true meaning within the context of additive structure.

The nature of the shift from counting to arithmetical operations is semantic as well as ontological, though it is not yet fully understood. However, we can and should smooth the way for this shift by engaging young children with tangible objects as substitutes for the true reference of the abstract objects of mathematics. However, these exemplifications should represent the true nature of the objects and relations of arithmetic.

Mathematical symbolism has developed as a need to express ideas that were ambiguous in natural language or to symbolise new ideas that were advanced. The uniqueness of mathematical symbolism is in its being a condensed language – a rigorous sign language that has a strict interpretation. Moreover, mathematical language makes more subtle distinctions that the natural language cannot make (unless intonation is involved). Let us take the following written phrase: ‘A fifth of a number decreased by 4’. Is the intention $1/5x - 4$ or $1/5(x - 4)$? Mathematical symbolism clearly makes the distinction between the two interpretations (meanings).

Another example is the interpretation of the word ‘is’. In natural language, its interpretation is derived from the given context. However, this word receives further distinctions in the formal language of mathematics and logic (Ayer, 1936/1972):

‘Is’ in the case of equality:	$A = B$	
‘Is’ in the case of class membership	$a \in B$	
‘Is’ in the case of class inclusion	$A \supset B$	
‘Is’ in the case of existence	$\exists X$	(p. 63)

This is the power of formal language vs natural language that made it so powerful in all sciences and many applications. It is also true of arithmetic and its simple operations, and we should not underestimate the precision of these expressions.

Admittedly, it is a problematical task to convey the meaning of the rigorous signs of arithmetic by translation to natural language. Neither ‘put end to end’, ‘put together’ or ‘go forward’ for the ‘+’ sign nor ‘take away’, ‘put side to side’ or ‘go back’ or ‘descend’ for the ‘-’ sign stands for the semantics of the mathematical additive relationships. It is important that teachers understand that the symbols of whole numbers, their operations and relations in arithmetic are not merely a new syntax for concepts learned in the past in the everyday environment, but rather a

difficult jump into a new symbolic domination. Mastering the symbolic language can be afterwards enriched and applied in everyday contexts via word problems given in natural language or other inquiry projects.

It is my conviction that acknowledging the big step the child must accomplish and devising new learning environments to assist in bridging the gap will avoid the failure of so many children who already feel alienated from mathematics in the early primary grades.

References

- Ayer, A. J. (1972). *Language, truth & logic*. London: Victor Gollancz.
- Bruun, F., Diaz, J. M., & Dykes, V. J. (2015). The language of mathematics. *Teaching Children Mathematics*, 21(9), 530–536.
- Butterworth, B. (2005). The development of arithmetical abilities. *Journal of Child Psychology and Psychiatry*, 46(1), 3–18.
- Cai, J., & Knuth, E. J. (Eds.). (2005). Algebraic thinking. *ZDM*, 37(1).
- Carey, S. (2004). Bootstrapping and the origin of concepts. *Daedalus*, 133(1), 59–68.
- Carraher, D. W., & Schliemann, A. D. (2015). 6 Powerful ideas in elementary school mathematics. In L. D. English & D. Kirshner (Eds.), *Handbook of international research in mathematics education* (3rd ed., pp. 191–219). New York/London: Routledge.
- Davydov, V. V. (1975). Logical and psychological problems of elementary mathematics as an academic subject. In L. P. Steffe (Ed.), *Soviet studies in the psychology of learning and teaching mathematics* (Vol. 7, pp. 55–107). Chicago: University of Chicago Press.
- Dehaene, S. (1997). *The number sense: How the mind creates mathematics*. New York: Oxford University Press.
- Dehaene, S., Piazza, M., Pinel, P., & Cohen, L. (2003). Three parietal circuits for number processing. *Cognitive Neuropsychology*, 20, 487–506.
- Dougherty, B. (2008). Measure up: A quantitative view of early algebra. In J. Kaput, D. Carraher, & M. Blanton (Eds.), *Algebra in the early grades* (pp. 389–412). Mahwah: Lawrence Erlbaum.
- Feigenson, L., Dehaene, S., & Spelke, E. S. (2004). Core systems of number. *Trends in Cognitive Science*, 8(7), 307–314.
- Fraenkel, A. (1942). *Introduction to mathematics*. Tel-Aviv: Masada. (in Hebrew).
- Frege, G. (1884/1980). *The foundations of arithmetic*. Evanston, Northwestern University Press.
- Fuson, K. C., & Hall, J. W. (1983). The acquisition of early number word meanings. In H. Ginsburg (Ed.), *The development of mathematical thinking* (pp. 49–107). New York: Academic.
- Gattegno, C. (1961). *A teacher introduction to the Cuisenaire-Gattegno method of teaching arithmetic*. Cuisenaire Company of America.
- Gattegno, C. (1962). *Modern mathematics with numbers in colours*. Reading: Lambert Gilbert Co. Ltd..
- Gattegno, C. (1971). *Now Johnny can do arithmetic: A handbook on the use of colored rods*. New York: Educational Solutions Worldwide Inc..
- Gelman, R., & Gallistel, C. R. (1978). *The child's understanding of number*. Cambridge, MA: Harvard University Press.
- Le Corre, M., & Carey, S. (2007). One, two, three, four, nothing more: An investigation of the conceptual sources of the verbal counting principles. *Cognition*, 105, 395–438.
- Mulligan, J., & Mitchelmore, M. (2009). Awareness of pattern and structure in early mathematical development. *Mathematics Education Research Journal*, 21, 33–49.
- Neshet, P. (1972). *From ordinary language to arithmetical language in the primary grades: A dissertation*. Cambridge, MA: Harvard University.

- Nesher, P. (1988). Precursors of number in children { a linguistic perspective. In S. Strauss (Ed.), *Ontogeny, phylogeny and historical development* (pp. 106–124). Norwood: Ablex Publishing Corporation.
- Nesher, P. (1989). Microworlds in mathematical education: A pedagogical realism. In L. B. Resnick (Ed.), *Knowing, learning, and instruction: Essays in honor of Robert Glaser* (pp. 187–226). Mahwah: Lawrence Erlbaum.
- Piaget, J. (1965). *The child's conception of number*. New York: Norton Company.
- Russell, B. (1919/1971). *Introduction to mathematical philosophy*. New York: The MacMillan company/Simon and Schuster.
- Schmittau, J. (2011). The role of theoretical analysis in developing algebraic thinking: A Vygotskian perspective. In J. Cai & E. Knuth (Eds.), *Early algebraization: A global dialogue from multiple perspectives* (pp. 71–86). Berlin: Springer.
- Vergnaud, G. (1982). QA classification of cognitive tasks and operations of thought involved in addition and subtraction problems. In T. P. Carpenter, T. M. Moser, & T. A. Romberg (Eds.), *Addition and subtraction: A cognitive perspective* (pp. 39–50). Hillsdale: Lawrence Erlbaum.

Papers cited from Sun, X., Kaur, B., & Novotna, J. (Eds.). (2015). Conference proceedings of the ICMI study 23: Primary mathematics study on whole numbers. Retrieved February 10, 2016, from www.umac.mo/fed/ICMI23/doc/Proceedings_ICMI_STUDY_23_final.pdf

- Butterworth, B. (2015). Low numeracy: From brain to education (pp. 21–33).
- Roberts, N. (2015). Interpreting children's representations of whole number additive relations in the early grades (pp. 245–250).
- Sinclair, N., & Coles, A. (2015). "A trillion is after one hundred": Early number and the development of symbolic awareness (pp. 251–259).

Open Access This chapter is licensed under the terms of the Creative Commons Attribution 4.0 International License (<http://creativecommons.org/licenses/by/4.0/>), which permits use, sharing, adaptation, distribution and reproduction in any medium or format, as long as you give appropriate credit to the original author(s) and the source, provide a link to the Creative Commons license and indicate if changes were made.



The images or other third party material in this chapter are included in the chapter's Creative Commons license, unless indicated otherwise in a credit line to the material. If material is not included in the chapter's Creative Commons license and your intended use is not permitted by statutory regulation or exceeds the permitted use, you will need to obtain permission directly from the copyright holder.



Chapter 9

Aspects that Affect Whole Number Learning: Cultural Artefacts and Mathematical Tasks



Maria G. Bartolini Bussi , Maitree Inprasitha 
Ferdinando Arzarello , Hyman Bass , Ulrich Kortenkamp ,
Silke Ladel , Caroline Lajoie , Yujing Ni, Thomas Rottmann ,
Veronica Sarungi , Sophie Soury-Lavergne , and Jenny Young-Loveridge 

9.1 Introduction

9.1.1 *What Was Presented at the Conference: Overview*

In this chapter, discussion of key socio-cultural aspects that affect learning will be considered from two complementary perspectives:

- Aspects that may help learning, especially if adequately exploited by the teacher.
- Aspects that may hinder learning, especially if not adequately contrasted by the teacher.

Thirteen papers written by authors from ten countries were accepted for Theme 3. For presentation and discussion, the papers accepted for Theme 3 were divided into subgroups according to their main focus. We are aware that it is not possible to make distinct groups of papers as there are several overlaps in the classification, but in

Electronic Supplementary Material The online version of this chapter (doi:[10.1007/978-3-319-63555-2_9](https://doi.org/10.1007/978-3-319-63555-2_9)) contains supplementary material.

The first two authors wrote the chapter with the collaboration of other working group members.

M.G. Bartolini Bussi (✉)
Department of Education and Humanities, University of Modena
and Reggio Emilia, Modena, Italy
e-mail: mariagiuseppina.bartolini@unimore.it

M. Inprasitha (✉)
Khon Kaen University, Khon Kaen, Thailand
e-mail: inprasitha_crme@kku.ac.th

F. Arzarello
University of Turin, Turin, Italy

H. Bass
University of Michigan, Ann Arbor, MI, USA

order to focus the group discussion, the main ideas from the papers are used to dictate the different time slots.

9.1.1.1 Language and Institutional Contexts

The contribution of participants from many different contexts offers a unique possibility to have first-hand reports about issues which may foster or hinder the construction of mathematical meanings.

Transparency vs Opacity Some papers addressed the transparency of language for Chinese (Ni 2015), Thai (Inprasitha 2015) and Maori (Young-Loveridge and Bicknell 2015) that was contrasted with the opacity of European languages such as French and German (Peter-Koop et al. 2015).

Pimm and Sinclair (2015) analysed the grammar of 20 different languages about fractions, discussing the information conveyed by each of them.

The Institutional Context Mercier and Quilio (2015) analysed the differences between primary school education about whole number arithmetic in four French-speaking countries, showing that language is only one of the variables to be considered when addressing the functioning principles of education systems.

9.1.1.2 Artefacts

A cluster of papers addressed different kinds of artefacts:

- The number line (Bartolini Bussi 2015; Electronic Supplementary Material: Bartolini Bussi 2017).
- Tallies and sequences of tallies (Hodgson and Lajoie 2015).

U. Kortenkamp
Universität Potsdam, Potsdam, Germany

S. Ladel
Universität des Saarlandes, Saarbrücken, Germany

C. Lajoie
Université du Québec à Montréal, Montreal, QC, Canada

Y. Ni
Chinese University of Hong Kong, Hong Kong, China

T. Rottmann
Bielefeld University, Bielefeld, Germany

V. Sarungi
Institute for Educational Development, The Aga Khan University, Dar es Salaam, Tanzania

S. Soury-Lavergne
IFE ENS de Lyon, Lyon, France

J. Young-Loveridge
University of Waikato, Hamilton, New Zealand

- Multibase arithmetic blocks and arithmetic rack or Slavonic abacus (Rottmann and Peter-Koop 2015; Electronic Supplementary Material: Rottmann 2017).
- Cuisenaire rods (Ball and Bass 2015), with a special challenging task for economically disadvantaged fifth graders.
- Artefacts from everyday life (Inprasitha 2015).
- Computer games (Bakker et al. 2015).
- Virtual manipulatives (Soury-Lavergne and Maschietto 2015; Ladel and Kortenkamp 2015).

9.1.1.3 Teacher Education

An overarching issue that encompasses the conditions for the learning of WNA concerns teachers' education and the effects it may have on their future students' processes. All the above papers, in some sense, hint at the importance of teacher education for the effective use of either language or other artefacts.

Two specific programmes for teacher education were reported:

- An approach developed in Canada (Laval University, Québec) for establishing the foundations of WNA with pre-service primary school teachers that highlights the role of mathematicians in the preparation of teachers in arithmetic and that also stresses the complementary role of mathematicians and mathematics educators in such an endeavour (Hodgson and Lajoie 2015)
- A programme developed in Thailand in order to adapt the Japanese Lesson Study to the Thai context (Inprasitha 2015, Electronic Supplementary Material: Inprasitha 2017)

9.1.2 The Discussion in the Working Group

The eight one-hour sessions were organised in different ways. At the beginning, two small groups were organised: (1) language to focus on different wording of 'ten' and (2) artefacts and mathematics to focus on relationships between epistemology and the choice/design of artefacts.

The language group discussed language for grouping, unitising into units and groups. In some countries (e.g. in England), the word 'unit' is used to refer to ones, as well as being a general collective term for different groups (e.g. hundreds, tens, ones). In some languages (e.g. French, German, Italian), there is a particular term used to label the unit for a particular group (e.g. *dizaine*, *zehner* or *decina* for ten). In contrast, English uses ten for the number of items and for the unit name. Moreover, they also discussed about language and wording in fractions and cardinal and ordinal names.

The artefact group discussed both traditional and ICT artefacts. They expressed the need to clarify the terminology according these questions: What is a representation? What is a model? What is an artefact? What is a tool? Furthermore, they discussed about artefacts which are designed and used with different intentions.

They stressed the importance of guidance (by the teacher) and the exploration of the artefacts by the students.

In the last session, there was only a mathematical task group.

The CANP observer, Veronica Sarungi (Tanzania), offered a lively report on the problems in South-East Africa, where the local languages are in conflict, in most cases, with the school language (see also this volume, Chap. 3). The three young observers from the Great Mekong Area (Weerasuk Kanauan, Visa Kim and Chanhpheng Phommaphasouk) were very active in videotaping all the sessions and preparing the report of the group discussion.

At the end the participants agreed that the *language* issue could have been enriched by the confrontation with participants in other working groups, in order to exploit the presence of more linguistic contexts (see Chap. 3). The participants rather chose to focus on *artefacts* (that was considered the true core of the working group discussion) and on *mathematical tasks*, whose careful choice may well foster or hinder learning of WNA. For the artefacts, they expressed the hope to collect together examples of artefacts presented in other working groups. This collective choice, reported in plenary session, determined the structure of this chapter.

9.1.3 The Structure of This Chapter

The core of this chapter is the notion of artefact, from the discussion of the meaning of the word in the literature to a gallery of cultural artefacts from the participants' reports and the literature. The use of cultural artefacts as teaching aids is then addressed. A special section is devoted to the artefacts (teaching aids) from technologies.

The issue of tasks was simply skimmed, as it was not possible to discuss about artefacts without considering the way of using artefacts with suitable tasks. There was no intention to overlap with the ICMI Study 22 (Watson and Ohtani 2015) that was attended by some participants in the ICMI Study 23, including the co-chairs (only the volume of proceedings was available at the time of the Conference). Some examples of tasks were reported to elaborate on aspects that may foster learning WNA, and some examples of tasks that might hinder learning were also reported. Artefacts and tasks appear as an inseparable pair, to be considered within the system of cultural and institutional constraints.

In the concluding remarks, some challenges are outlined, in order to contend with this complex map.

9.2 Cultural Artefacts

9.2.1 *The Use of Different Terms with Similar (Not the Same) Meaning*

9.2.1.1 The Historic-Cultural School

In the literature, many different words have been used to describe artefacts. One of the difficulties comes from the existence of literature in different languages, with various challenges of translation. The case of translations from Vygotsky's original papers in Russian is emblematic. Vygotsky is the founder of the so-called historic-cultural school, where the notion of mediation by cultural artefacts is central. According to Russian scholars (Anna Stetsenko, personal communication), the major term used by Vygotsky in his papers is *sign* (or *symbol* interchangeably), in Russian знак (*znak* in transliteration), so that the construct of semiotic mediation is expressed in this way '*znakovaya kulturnaya mediatsija*' (знаковая, культурная медиация), meaning symbolic cultural mediation. In the English translations, several different terms were used with related yet different meanings.

In 1930, Vygotsky gave a talk on *The Instrumental Method in Psychology* at the Krupskaya Academy of Communist Education that was later included in different readings. The English version of the transcript reads:

In the behavior of man we encounter quite a number of artificial devices for mastering his own mental processes. By analogy with technical devices these devices can justifiably and conventionally be called psychological tools or instruments. [...] Psychological tools are artificial formations. By their nature they are social and not organic or individual devices. They are directed toward the mastery of [mental] processes – one's own or someone else's – just as technical devices are directed toward the mastery of processes of nature. The following may serve as examples of psychological tools and their complex systems: language, different forms of numeration and counting, mnemotechnic techniques, algebraic symbolism, works of art, writing, schemes, diagrams, maps, blueprints, all sorts of conventional signs, etc. (Rieber and Wollock 1997, p. 85)

In this translation, different kinds of terms are used: (psychological) tool, instrument, artificial formation or device. The idea of 'artificial device', whence the short name 'artefact', was used by Yrjö Engeström (1987) and subsequently by Michael Cole (1996). Cole argued in favour of using 'artefacts', as a more generic term (1996, p. 108). Cole connected artefact mediation to Dewey's analysis of tools and works of art, claiming that Dewey's works were 'well known among Russian educators and psychologists' (p. 109). This direct scientific connection between Dewey and Vygotsky is intentional, as Cole claims that his 'focus will be on an attempt to formulate an approach to psychology that draws upon both national traditions' (p. 115). This choice makes Vygotskian ideas closer to US scholars, but not everybody agrees on the mutual consistency of the two national traditions. For instance, Stetsenko (2008) writes:

Whereas both Dewey and Piaget (and many of their contemporary followers in the relational ontology approach) treated human beings as no different than other biological

organisms—thus keeping up with the Darwinian notion that ‘nature makes no drastic leaps’—Vygotsky and his followers postulated precisely such a leap and turned to exploring its implications. In doing so, these scholars followed with the Marxist dialectical materialist view according to which “...[the] base for human thinking is precisely *man changing nature* and not nature alone as such, and the mind developed according to how human being[s] learned to change nature” (Engels quoted in Vygotsky 1997, p. 56; italics in the original). (p. 482)

In the same manner, Xie and Carspecken (2007), in their comparative analysis of US and Chinese mathematics curricula, contrast Dewey and Marx as representatives of two very different paths of departure from Hegelian idealism with strong influence on educational choices.

The notion of artefact was elaborated in the so-called activity theory approach (e.g. Engeström 1987) and exploited in mathematics education by other authors (see Bartolini Bussi and Mariotti 2008 for a review).

In the further literature on the instrumental approach, an artefact is meant ‘as the – often but not necessarily physical – object that is used as a tool’ (Hoyles and Lagrange 2010, p. 108), while:

[an instrument requires a relationship] between the artefact and the user for a specific type of task. Besides the artefact, the instrument also involves the techniques and mental schemes that the user develops and applies while using the artefact. To put it in the form of a somewhat simplified ‘formula’ we can state: Instrument = Artefact + Schemes and techniques, for a given type of task. (p. 108)

In this case, the reference is to Rabardel’s (1995) instrumental approach.

In this chapter, however, we shall not strictly use this distinction, and in most cases we shall refer to artefacts in a more generic way, as mathematics educators, anthropologists and historians do not always adhere to either of the above theoretical frameworks.

9.2.1.2 The Theory of Semiotic Mediation: The Teacher’s Side

The notion of artefact (in the Vygotskian sense) is central in the *theory of semiotic mediation* as developed by Bartolini Bussi and Mariotti (2008). In this framework, there are two main foci: the function of cultural artefacts, developed by mankind, and the teacher’s role as cultural mediator.

The teacher is in charge of two main processes: the *design of activities* and the *functioning of activities*. In the former, the teacher makes sound choices about the artefacts to be used, the tasks to be proposed and the pieces of mathematics knowledge to be addressed, taking into account the curricular choices. This means that mathematics knowledge is, in this framework, the *taught knowledge* to be distinguished from the *scholarly knowledge* (Chevallard and Bosch 2014). In the latter, the teacher exploits, monitors and manages the children’s observable processes, to decide how to interact with them and what and how to fix in the individual and group memory. The design process is encapsulated by the left triangle of Fig. 9.1, where the *semiotic potential* of the artefact is described. The semiotic potential concerns the double semiotic link defined by the use of the artefact to accomplish

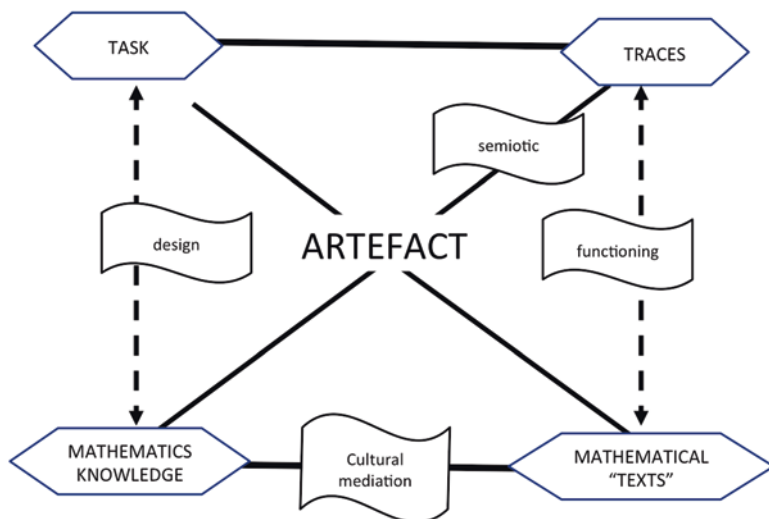

Fig. 9.1 Semiotic mediation

the task and the mathematical meanings related to the artefact and its use. The other parts of the scheme concern the *functioning in the classroom*. When students are given a task, they start a rich and complex semiotic activity, producing traces (gestures, drawings, oral descriptions and so on). The teacher's job is first to collect all these traces (observing and listening to children), to analyse them and to organise a path for their development towards mathematical 'texts' that can be put in relationship with the pieces of mathematics knowledge into play. In this process, the teacher organises the alternation (in what is called a *didactical cycle*) of individual and small group use of the artefact and production of signs to solve the task and of large group mathematical discussion.

In this way, artefacts become *teaching aids* as they are used in knowledge transmission (e.g. in schools) with didactical intentions. In the literature very often some kinds of teaching aids are named *manipulatives*, in order to highlight the possibility to manipulate them in the process of construction of mathematical meanings (Bartolini Bussi and Martignone 2014; Nührenbörger and Steinbring 2008). Recently, many *virtual manipulatives* have been produced thanks to the increasing distribution of technologies, sometimes without a careful investigation of the cognitive difference (and distance) between a direct manipulation and a mediated manipulation, for instance, by means of the digital mouse (<http://nlvm.usu.edu/en/nav/vlibrary.html>). For relevant exceptions, see Sect. 9.3.4.

9.2.1.3 Artefacts and Representations: The Learner's Side

When artefacts are in play, what is in the foreground is not the mathematical concept itself but an external *representation* (or a *model*) of it. In this sense, artefacts 'allow children to establish connections between their everyday experiences and

their nascent knowledge of mathematical concepts and symbols’ (Uttal et al. 1997, p. 38). Nevertheless, the role of an artefact to be a representation is not necessarily obvious for children. In this context, Uttal et al. (1997, p. 43) mention a ‘dual-representation hypothesis’: Any artefact can be thought of as a representation that stands for something else or as an object on its own. The latter view might provide a reason for children’s learning difficulties:

Concrete objects can help children gain access to concepts and processes that might otherwise remain inaccessible. However, there is another side to the use of concrete objects: children may easily fail to appreciate that the manipulative is intended to represent something else – that it is a symbol. If so, the manipulative will be counterproductive. (Uttal et al. 1997, p. 52)

Similar concerns about the focus of attention in using manipulatives are expressed by Nührenböcker and Steinbring (2008), with the same problem applying to virtual manipulatives as well (see Sect. 9.3.4).

Monaghan, Trouche and Borwein (2016) have an ambitious approach with a coverage from prehistory to future directions in the field, with a major emphasis on modern technologies, addressing the areas of curriculum, assessment and policy design.

After this short review about the function of artefacts in the literature on mathematics education, it is worthwhile to present some examples of cultural artefacts, drawing on the examples mentioned by the participants.

9.2.2 Cultural Artefacts for WNA

The history of mathematics is replete with the creation of artefacts, some disseminated all over the world, while others are related to a particular culture. Hence, cultural artefacts are important in both the history and geography of mathematics and reveal something about the cultures that have produced and used them, as well as about the image of mathematics in that culture. Some of them may be exploited to reconstruct the cultural identity of learners or to construct mathematical concepts.

According to Vygotsky’s list quoted in Sect. 9.2.1, language is the first example of artefact (sign) directed towards the mastery of mental processes. Language is at work in both everyday and school contexts. The connection between language and numbers (including whole number arithmetic) is far from being natural or universal. In this volume (Chaps. 3 and 5), the variation of different forms of numeration and counting are explored with reference to the history and geography of whole number arithmetic. In some cases language can foster learning; in some cases it can hinder learning. In this chapter, we analyse a typical example where language (and culture) makes the difference (see the case of *epistemological obstacle* in Sect. 9.3.2). Language enters also in the activity with other artefacts, when tasks are given by language or to be answered by language. The gallery of examples is organised in the following way:

- Ancient artefacts to represent numbers and compute (tallies, counting rods, *quipus* and *yupana*)
- Abaci

- Artefacts for multiplication (pithy tables, Napier bones, ‘gelosia’ scheme)
- The number line
- Songs, poems and dance
- Games
- Everyday artefacts
- Textbooks and d-books

9.2.2.1 Ancient Cultural Artefacts to Represent Numbers and Compute

Tallies (this volume, Sects. 5.2.3.1 and 10.4.1) are, according to historians (Menninger 1969), the most ancient representations of numbers (Fig. 9.2).

Tallies are still used in election poll counting (Fig. 9.3).

Tallies were used for centuries also in double tally sticks (Menninger 1969, p. 223) for commercial exchanges:

A long piece of wood is cut lengthwise almost the end; the part with the large end is the ‘stock’ (the main stick) and the split-off portion is the ‘inset’ (the piece laid on the main stock). [...] When a payment or delivery is either made or received, the debtor insert his inset in the stock, which the creditor generally keeps, and notches are cut into or removed from both pieces at once. Then both parties take back their own pieces and keep them until the final settlement. In this marvelously simple fashion, the ‘double bookkeeping’ makes any cheating impossible. (p. 231)

According to Menninger (1969, p. 233), the Chinese character for ‘contract’ (契, qìjù) is very meaningful.

The word for ‘contract’ in Chinese is symbolized by two characters at the top, one for a tally stick (stick with notches) and one for a knife, and another at the bottom which means ‘large’. A ‘contract’ or ‘agreement’ in Chinese is thus literally a ‘large tally stick’.

Sequence of tallies is among the founding elements of an arithmetic course that was developed in Canada (Laval University, Québec) for the preparation of pre-service elementary school teachers (this volume, Chap. 10). In that course, tallies are used to fully define natural numbers and operations on those numbers; capture

Fig. 9.2 The Ishango bone
(http://www.cs.mcgill.ca/~rwest/link-suggestion/wpcd_2008-09_augmented/images/234/23448.jpg.htm)



Fig. 9.3 Tallies for ballot counts



Fig. 9.4 Chinese counting rods from excavation



Fig. 9.5 Chinese counting rods from Mekong area (personal collection of the first author)

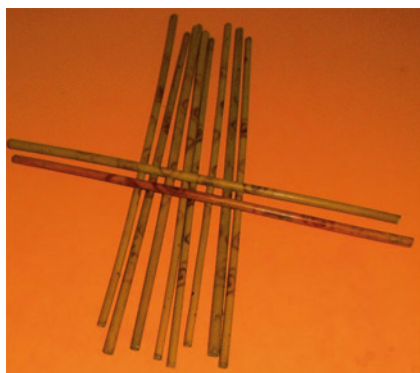

the notion of equality; prove some fundamental properties, such as the commutativity of addition; and more (Hodgson and Lajoie 2015).

Counting rods (筹; *chóu*, this volume, Chaps. 3 and/or 5) were used in ancient China (Zou 2015), with the possibility of distinguishing positive (red) and negative (black) numbers too, and gave rise also to the ancient Chinese characters for numbers (Fig. 9.4) (see this volume, Chap. 3).

Later they were spread all over the world and are one of the most effective strategies to introduce place value by means of bundles. Figure 9.6 shows an ancient method textbook for teachers, published in Italy in 1920. A comparison between Figs. 9.5 and 9.6 shows that the Chinese rods are bamboo, while the Italian sticks represent other European species of trees.

Quipu (González and Caraballo 2015) is a system of strings (Fig. 9.7), used by Incas, with different colours and different knots, where the position of knots and the colours of the strings determine the number to be represented. According to Jacobsen (1983):

Documented evidence, however, provides that early Hawaiians and ancient Chinese predated the Incan usage. Studies concentrating on the quipu as an accounting device rather than as an element in the evolution of the writing process might provide valuable contributions to the solution of the mystery surrounding this artifact. Insight into the development of mankind in the Pacific may be gained by understanding the use of the quipu in the East and West, and in Hawaii—the “meeting place” of the Pacific. (p. 53)

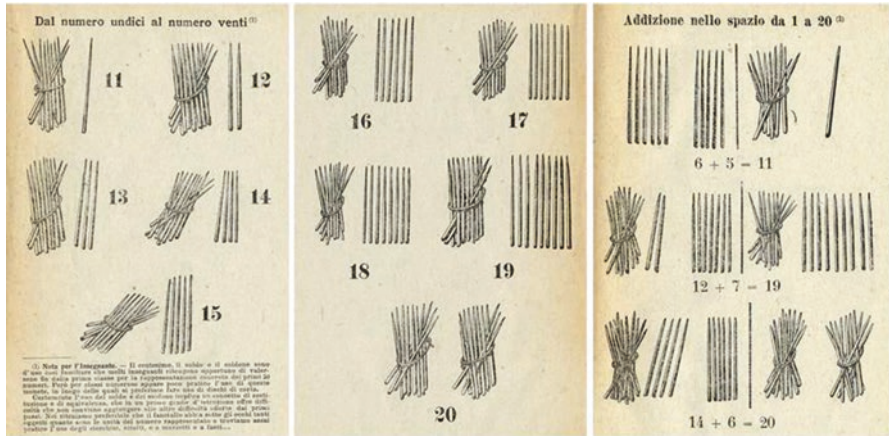
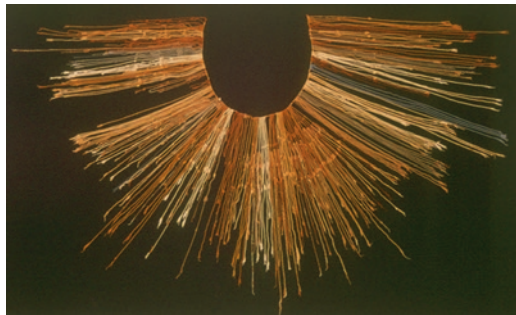

Fig. 9.6 Counting rods from Conti (1920)

Fig. 9.7 An Inca quipu from the Larco Museum in Lima (https://commons.wikimedia.org/wiki/File:Inca_Quipu.jpg)



In Fig. 9.8, besides quipus also a yupana is represented. According to Gonzales and Caraballo (2015), it draws on a base-ten system. It was used by Incas to do arithmetical operations. It is still used as a teaching aid in Peru in intercultural education programmes.

9.2.2.2 Abaci

Different kinds of abaci are present in the history and geography of arithmetic. The Roman abacus, suàn pán (算盘), soroban (そろばん) and schoty (счёты) share some features of bead arithmetic:

- In each column, one bead is equal to ten beads of the adjacent column on the right.
- Each column is divided into two parts: each bead of the top part is equivalent to five beads on the bottom.

Fig. 9.8 *Quipu* and *yupana* (By Felipe Guaman Poma de Ayala (<https://commons.wikimedia.org/wiki/File:Yupana.jpg>))



The Chinese 算盘 (*suàn pán*) and the Japanese そろばん (*soroban*) have a similar structure but with a different number of beads (Sun 2015; see also Chap. 5).

The Russian счёты (*schoty*) is not organised in columns but in rows, where one bead is equivalent to the bead of the adjacent row below, with one exception (the row for quarter kopek, an ancient coin) (Figs. 9.9, 9.10, 9.11 and 9.12).

Inspired by the Russian abacus, the so-called Slavonic abacus (or *arithmetic rack*) was introduced in Europe by Kempinsky (1921) who gave it the name of *Russische Rechenmaschine* (Rottmann and Peter-Koop 2015); see also Sect. 9.2.3.

Yet, during time, the positional value, where rows represent units, tens, hundreds, thousands and so on, was replaced by the convention that each bead represents a unit, whichever is the column or row (see also Sect. 9.4.1) (Fig. 9.13).

9.2.2.3 Artefacts for Multiplication

Pithy tables (or *nine times tables* or *multiplication tables*) are popular all over the world with different names. For instance, in Italy, the table of Fig. 9.14, printed in the last page of notebooks until 50 years ago, was named ‘*tavola pitagorica*’, but it is not clear why Pythagoras is mentioned.

Fig. 9.9 Roman abacus
 (<https://commons.wikimedia.org/wiki/File:RomanAbacusRecon.jpg>)

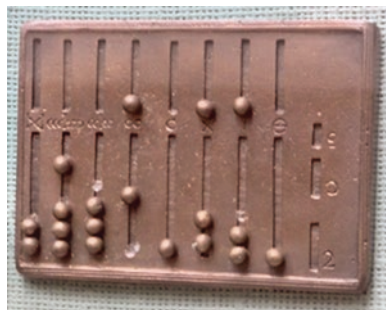

Fig 9.10 A precious ancient jade *suàn pán* 算盘 (personal collection of the first author)



Fig 9.11 A *soroban* (personal collection of the first author)



Fig 9.12 A *schoty* (personal collection of the first author)



According to historians (Lam and Ang 2004, p. 73 ff.) in China, this table was an integral part in the rudiments of counting, as from the seventh century BCE (this volume, Sect. 15.5). Later, it was known as the ‘nine nines song’, as the learner had to recite the numbers in a singing manner to memorise the table. The reduced forms in Chinese textbooks (Fig. 9.15) draw on commutative property (Cao et al. 2015).

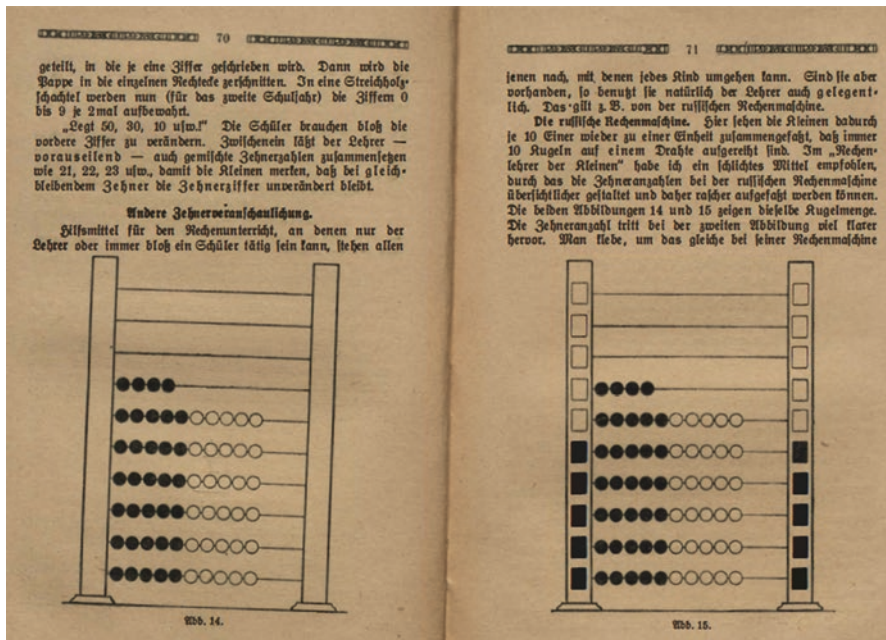

Fig. 9.13 The arithmetic rack (Kempinsky 1921)

Fig. 9.14 ‘Tavola pitagorica’ from an Italian notebook (around 1960, personal collection of the first author)

TAVOLA PITAGORICA

1	2	3	4	5	6	7	8	9	10	11	12
2	4	6	8	10	12	14	16	18	20	22	24
3	6	9	12	15	18	21	24	27	30	33	36
4	8	12	16	20	24	28	32	36	40	44	48
5	10	15	20	25	30	35	40	45	50	55	60
6	12	18	24	30	36	42	48	54	60	66	72
7	14	21	28	35	42	49	56	63	70	77	84
8	16	24	32	40	48	56	64	72	80	88	96
9	18	27	36	45	54	63	72	81	90	99	108
10	20	30	40	50	60	70	80	90	100	110	120
11	22	33	44	55	66	77	88	99	110	121	132
12	24	36	48	60	72	84	96	108	120	132	144

一一得一 (1×1=1)									
一二得二 (1×2=2)	二二得二 (2×2=4)								
一三得三 (1×3=3)	二三得六 (2×3=6)	三三得九 (3×3=9)							
一四得四 (1×4=4)	二四得八 (2×4=8)	三四十二 (3×4=12)	四四十六 (4×4=16)						
一五得五 (1×5=5)	二五一十 (2×5=10)	三五十五 (3×5=15)	四五二十 (4×5=20)	五五二十五 (5×5=25)					
一六得六 (1×6=6)	二六十二 (2×6=12)	三六十八 (3×6=18)	四六二十四 (4×6=24)	五六三十 (5×6=30)	六六三十六 (6×6=36)				
一七得七 (1×7=7)	二七十四 (2×7=14)	三七二十一 (3×7=21)	四七二十八 (4×7=28)	五七三十五 (5×7=35)	六七四十二 (6×7=42)	七七四十九 (7×7=49)			
一八得八 (1×8=8)	二八十六 (2×8=16)	三八二十四 (3×8=24)	四八三十二 (4×8=32)	五八四十 (5×8=40)	六八四十八 (6×8=48)	七八五十六 (7×8=56)	八八六十四 (8×8=64)		
一九得九 (1×9=9)	二九十八 (2×9=18)	三九二十七 (3×9=27)	四九三十六 (4×9=36)	五九四十五 (5×9=45)	六九五十四 (6×9=54)	七九六十三 (7×9=63)	八九七十二 (8×9=72)	九九八十一 (9×9=81)	

Fig. 9.15 The reduced pithy table from an old Chinese textbook

In each line, only the case of $a < b$ for $a \times b$ is written.

An original way of approaching the multiplication table is suggested by Baccaglioni-Frank et al. (2014) within the *PerContare* project, drawing on Pythagoras’ studies on figurate numbers and Euclid’s further development of geometric algebra (this volume, Chap. 7). The product of two numbers $a \times b$ is represented in the table by a rectangle with sizes a and b . In this way, the construction of the table is justified by a spatial approach, and some properties of multiplication (e.g. commutative, distributive) are evident.

Napier’s bones (or rods) are an artefact for multiplication, drawing on nine times table. Each rod is a strip of wood, metal or heavy cardboard. A rod’s surface comprises ten squares: the first holds a single digit, while the others comprise two halves divided by a diagonal line. In each square there are the multiples of the number on the top. In Fig. 9.16, there is a collection of Napier’s rods together with an example of application.

A similar approach, on paper and pencil without rods, is in the *Gelosia (or lattice) multiplication* (Siu 2015; see Fig. 9.17). It is an algorithm, probably from Arabic culture, but later spread also in Europe (through Italy): the advantage of this method in the classroom is that every result from the nine times table is written and only later combined with others. Hence, the control of the single steps of the process is fostered.

9.2.2.4 Number Line

The *number line* (Bartolini Bussi 2015, and this volume, Chaps. 15 and 19) draws on the Euclidean tradition of representing numbers with line segments. It was transformed into a teaching aid in Europe in the seventeenth century. Now number lines are part of everyday experience of pupils, either in games (e.g. the board *game of the Goose* especially popular in Southern Europe) or in everyday tools (e.g. the graded ruler or scales in measuring instruments with direct reading).

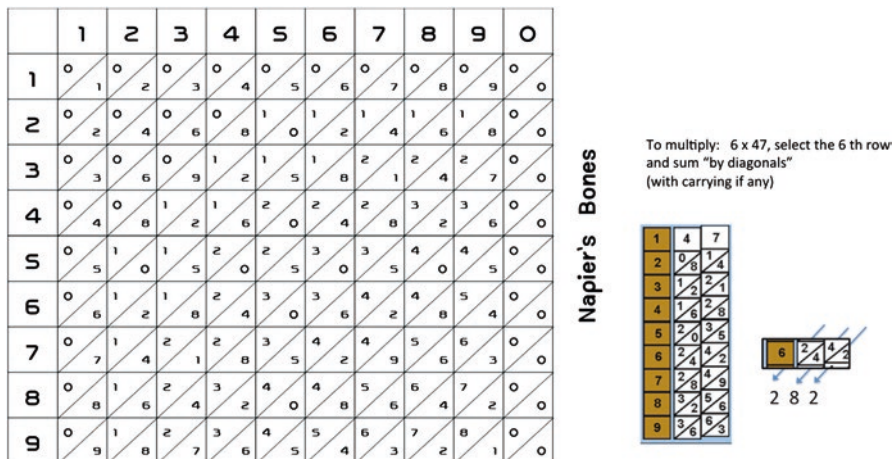
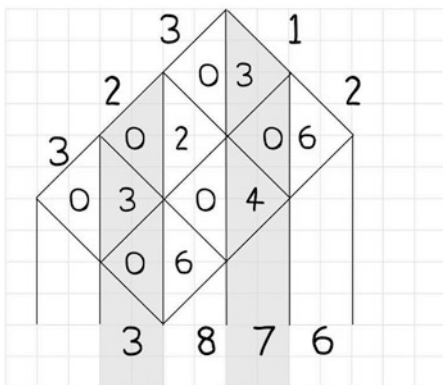

Fig. 9.16 Left: Napier's bones. Right: instruction

Fig. 9.17 Gelosia multiplication:
 $323 \times 12 = 3876$



9.2.2.5 Songs, Poems and Dance

The recitation of nine times table as a song was already mentioned above. The tradition of recitation in mathematics learning was widespread in many parts of the world too. For instance, in India (Karp and Schubring 2014):

The recitation involved knowing how to chant Vedic verses following many systematic combinations of their syllables, first in order, then inverting one verse/syllable after another, then reciting it backwards, and so on, so that the recitation itself could be seen as an application of a systematical "mathematical" combination". (p. 71)

There are also cultures in Africa where dancing and singing together is a way to recite and learn numbers (Electronic Supplementary Material: Sarungi 2017; see also Zaslavsky 1973, Chap. 10).

Meaney, Trinick and Fairhall (2012) report an activity about whole number arithmetic, taken from a New Zealand television programme and based on the principles of *kapa haka*, a traditional team dance where actions emphasise the sung or chanted words, using the body as the instrument for delivery.

The role of the body is evident also in a video clip (Electronic Supplementary Material: Arzarello 2017) about a project developed in an Italian first-grade classroom (this volume, Chap. 15). Students learn to recite the numbers according to the regular and transparent Chinese structure that is different from the Italian one. Hence, they say: ‘nine, ten, ten-one, ten-two, ten-three...’ accompanying this recitation with large-size arm gestures, which help them to keep up the pace.

9.2.2.6 Games

Many games embody number properties. Some examples follow.

- Traditional games (e.g. the goose game; see above); *mancala* (Fig. 9.18), an African game with seeds (Zaslavsky 1973, Chap. 11).
- Magic squares (in China, Africa, Europe) (Fig. 9.19).
- Playing cards with special patterns fostering *subitising* (see Sect. 7.2.1).
- Games from recreational mathematics.

Recreational mathematics has been popular all over the world, since ancient times (see also Zaslavsky 1973, Sect. 9.4). Singmaster has collected a large set of sources, many of which concern WNA.¹ Gardner has published hundreds of columns in *Scientific American* and other books.² Famous collections have been published in the former Soviet Union (Kordemsky 1992) and in Latin America. The book by Malba Tahan (1996), the pen name of Júlio César de Mello e Souza, tells the fictitious story of an Arab mathematician of the fourteenth century, as a series of

Fig. 9.18 A *mancala* (personal collection of the first author)



Fig. 9.19 Playing cards (personal collection of the first author)



¹ <http://www.puzzlemuseum.com/singma/singma-index.htm>

² <http://martin-gardner.org>

tales in the style of the Arabian Nights, but revolving around mathematical puzzles. The book was very popular in Brazil and was translated into many languages including Arabic.

Games have been implemented also in devices of computer technology, as computer games (Bakker et al. 2015) and applets for multitouch technologies (see Sect. 9.3.4).

9.2.2.7 Everyday Artefacts

Everyday artefacts reflect mathematical ideas. Some examples:

- Banknotes and coins.
- Cake boxes (like the ones used in the Hou Kong School, this volume Chap. 11) or egg boxes with regular organisation of places.
- Stamp sheets (organised in ten lines of ten stamps each) (see Inprasitha 2015).

9.2.2.8 Textbooks

Mathematics textbooks have been for centuries the most widespread artefacts all over the world. In this chapter, we wish to put only a signpost for this issue that is considered elsewhere in this volume (Chap. 11). We shall devote some space to d-book only (see Sect. 9.3.4.4).

9.3 When Artefacts Are Teaching Aids: The Construction of Mathematical Meanings

A cultural artefact may become a teaching aid when it is used in schools with didactical intentions. In the previous section, we have collected a gallery of examples, most coming from the history of mathematics. We have also briefly mentioned some didactical use of them. In this section, we shall deepen this point, discussing some issues relating to the teaching and learning process.

9.3.1 Some Modern Artefacts

A teacher or a mathematics educator may design an original artefact with specific intentions. Some examples from the history of mathematical instruction follow.

9.3.1.1 Cuisenaire Rods

Cuisenaire rods (this volume, Chaps. 8 and 10) are used to represent numbers with coloured rods of different length, in the trend already introduced by Froebel and Montessori. They were designed in the 1920s by the wife of Georges Cuisenaire, a Belgian educator, in order to make arithmetic visible. Some decades later Caleb Gattegno named them Cuisenaire rods and started to popularise them. In this case, the number is approached through measuring. Nesher (this volume, Chap. 8) analyses them according to Peano's axioms. These rods may be used also to create challenging tasks (Ball and Bass 2015). They have also inspired some apps like number bonds by Diana Laurillard.³

9.3.1.2 Multibase Arithmetic Blocks

MAB (multibase arithmetic blocks) are one of the most popular teaching aids to introduce place value (see Chap. 4). They provide concrete representations for the number bases (Dienes 1963). They model numbers with objects hinting at different dimensions (see Ladel and Kortenkamp 2015; Rottmann and Peter-Koop 2015). In spite of the diffusion, they have been criticised from an epistemological and cognitive perspective (Stacey et al. 2001), suggesting, instead, of using *Linear Arithmetic Blocks (LAB)* that model numbers with length, showing the position of numbers on a number line.

9.3.1.3 Spike Abacus

The *spike abacus* is inspired by the abaci of the past containing different wires with beads referring to units, tens, hundreds and similar (Fig. 9.20). In some traditions (e.g. Baldin et al. 2015), it is common to use different colours for units, tens and so on and to transcribe multi-digit numbers using pens of different colours, with the purpose of making differences more evident. This choice seems not advisable, as attention is focused on colours and exchange conventions rather than on order and position.

9.3.2 Artefacts for Place Value: *The Cultural Roots of Epistemological Obstacles*

Some of the examples of our gallery address a crucial issue in WNA, which is place value (this volume, Chaps. 3 and 5). Counting rods (筹; *chóu*) and all the kinds of abaci, for instance, are strongly related to place value. As argued in this volume

³<http://thinkout.se/thinkout-products/number-bonds/>

Fig. 9.20 A monochrome spike abacus (personal collection of the first author)



(Chap. 5), place value, at least in the Western culture, hints at an *epistemological obstacle*, with influences on the teaching and learning processes.

An epistemological obstacle may be described, after Brousseau and Bachelard, as follows:

Brousseau's approach is based on the assumption that knowledge exists and makes sense only because it represents an optimal solution in a system of constraints. [...] In Brousseau's view knowledge is not a state of the mind; it is a solution to a problem, independent of the solving subject. (Fauvel and van Maanen 2000, p. 162)

Usually epistemological obstacles are related to the historical process of constructing mathematical knowledge by mankind and are likely to appear anew in the mathematics classrooms. But, as we show below, this idea has to be carefully analysed with a lens of cultural and language relativism. The cultural roots of epistemological obstacles have been discussed by Sierpinska (1996) and Radford (1997; see also D'Amore et al. 2016). In a recent study on language impact on the learning of mathematics, Dong-Joong et al. (2012) observed:

More generally, this study brings to the fore the importance of teachers' awareness of the unique, language-dependent properties of the discourse to which they are going to usher their students. The teachers need to be cognizant of those language-specific features of the discourse that may support learning and of those that may hinder successful participation. Thus, to support meaningful learning in English-speaking classes, instructors may wish to deliberately capitalize on the existing lexical ties between students' informal talk and formal mathematical discourse on infinity. But these teachers should also remember that the continuity has its dark side, in that it may hinder the necessary change: at different levels, the same words are used in different ways, but the required transformation may be difficult for the students not just to implement, but even to see. (p. 106)

The study was about infinity with secondary school students in the USA and Korea, but the same observation might be applied to place value in WNA. From a Western perspective, we know (Menninger 1969, p. 39 ff) that the early representations of whole numbers were in most cases based on additive rules (this volume Chap. 5). Representation of numbers and computing seemed to be quite different issues: numbers were represented in additive form, and the operation to solve arith-

Fig. 9.21 An ancient Italian manuscript

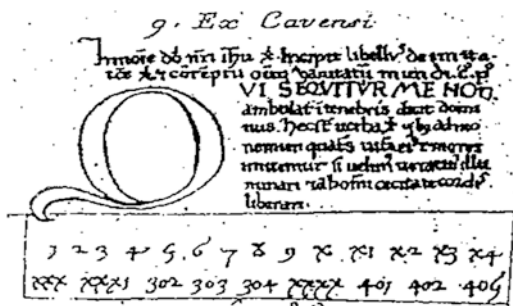

metic problems were solved by some artefacts before transcribing the results. In the previous section, we have mentioned the Roman abacus, which worked on a positional rule, while numbers were written drawing on additional system.

The situation was different in China (this volume, Chaps. 3 and 5), where the links between the representation of whole numbers (in both words and symbols) and the artefacts for computing (e.g. counting rods and *suàn pán*) was very strict from the beginning and with no interruption between them.

In Europe, when representation of numbers according to non-positional (additive) systems was in use, no need for ‘zero’ to represent the empty positions on the abacus emerged. When eventually ‘zero’ was introduced in Europe from the East through the Arabic tradition together with the so-called Hindu-Arabic digits, the advantage of this introduction was not immediately acknowledged.

The medieval Italian manuscript of Fig. 9.21 shows the problems in shifting from the Roman notation to the new one (Fauvel and van Maanen 2000, p. 151).

What happens today in the (Western) mathematics classrooms?

When 7-year-old students are asked to write numbers, a common mistake in transcoding from number words to Hindu-Arabic numerals shows up: some students write ‘10,013’ instead of ‘113’ as the zeroes on the right (100) are not overwritten by tens and units. [...] This mistake is stable and resists direct teaching of place value. [...] rather than using place value conventions, the students seem to use digits to transcribe oral numerals. (Bartolini Bussi 2011, p. 94)

The (Western) epistemological obstacle requires recourse to specific activities to be overcome. It is necessary to reconstruct the link between representing numbers orally and in written forms, which seems so natural in Chinese classrooms (this volume, Chap. 15). This may be done using some kind of artefacts and tasks. For instance, it is possible to use cultural artefacts such as abaci or counting rods (inherited from the history of mathematics and strictly linked to place value development) or artefacts from everyday life. This last case is reported in a study by Young-Loveridge and Bicknell (2015), who assert that ‘place value understanding is inherently multiplicative’ and that ‘multiplicative thinking involves working with two variables (number of groups and number of items per group) and these are in a fixed ratio to each other, in a many-to-one relationship’ (p. 379). This implies that ‘a key feature of place-value development is the shift from a unitary (by ones) way of thinking about numbers to a multi-unit conception, e.g., tens and ones’ (p. 381). Drawing

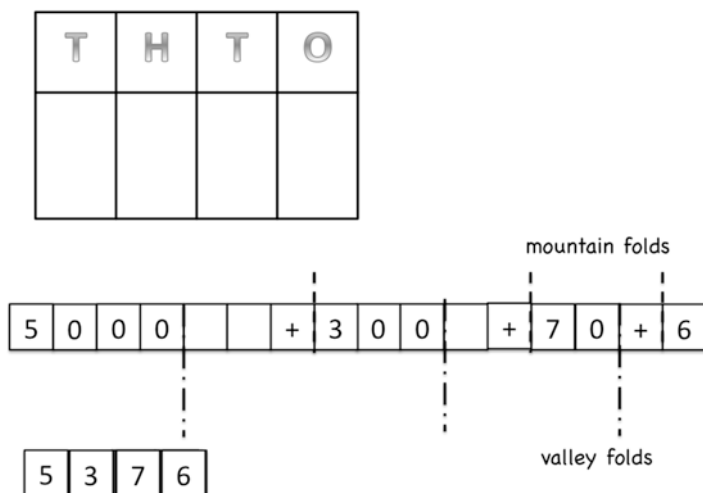

Fig. 9.22 Place value chart and a foldable strip representing 5376; folded it shows the four-digit number; unfolded it shows the sum of thousands, hundreds, tens and ones

on these results, the authors have designed and carried out a study with 35 5-year-old children who solved word problems including multiplication, division and place value. Place value was approached by using everyday artefacts (e.g. egg carton with exactly ten eggs; gloves with five fingers). The study showed that most children were able to work with fives and tens by the end of the programme.

In both cases, artefacts become teaching aids: in the former case, they are taken from the history of culture; in the second case, they are taken from everyday life. The choice depends on the implicit systems of values and on the image of mathematics: to construct the cultural identity by referring to the (local) history of mathematics or to highlight the links between arithmetic and everyday life. The difference is not so strict, as in some cases, the use of cultural artefacts from the history of mathematics is still extant in everyday life, as Chinese 算盘 (*suàn pán*) and Japanese そろばん (*soroban*).

Other very simple artefacts may be used, like *place value charts* or *foldable strips*. A foldable strip shows the number as a sum of thousands, hundreds, tens and units (when opened) and as a four-digit number when folded as the zeroes are overwritten (Fig. 9.22).

9.3.3 Artefacts for Low Achievers: Another Example of Cultural Difference

We have mentioned the number line, a cultural artefact, whose history in Europe may be traced back to the importance of geometry since the classical age (Bartolini Bussi 2015). The number line is very often used in the Western mathematics

Fig. 9.23 A child jumping on a floor number line



education to introduce addition and subtractions by motion forwards and backwards, but it is not so popular in China (this volume, Chap. 15).

Figure 9.23 is taken from a video clip (Electronic Supplementary Material: Bartolini Bussi 2017), where a student jumps on the floor, exploring a big-size number line.

A smaller-size number line drawn on a sheet of paper (Bartolini Bussi 2015) may be used with low achievers (e.g. dyscalculic children) to introduce addition and subtraction. The following is the prototype of a dialogue (one-to-one interaction) between a low achiever and a caregiver. The child can read numbers but cannot retrieve from memory simple arithmetic facts. There is a number line drawn as a linear sequence of positions numbered from 0 to 10. The pawn to be moved is called Tweety. The task is to calculate $4 + 3$.

Adult: 'Put Tweety on the 4.'

(done)

Adult: 'Keep Tweety steady and count on 3 with your finger.'

(done)

Adult: 'Read the number.'

Child: 'Seven.'

Adult: 'Good job! $4 + 3 = 7$.'

The activity aims at constructing a very simple procedure to be used by the low achiever first in a guided way and then independently, to acquire autonomy in the construction of simple number facts (addition in this case). The signs + and – on the top are reminders for the direction for addition and for subtraction (Fig. 9.24).

We may compare this activity with the more common activity of tracing small arches on the number line, as in Fig. 9.25.

Teachers report difficulties with low achievers as they are not able to coordinate counting with tracing small arches: sometimes they count twice the vertical segments pointing at each number (both up and down) and become confused.

Fig. 9.24 Moving Tweety on the number line

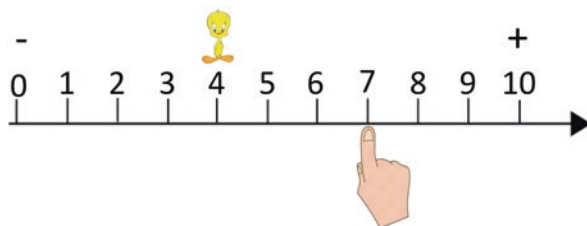
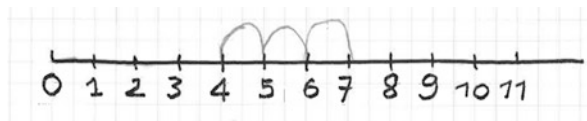

Fig. 9.25 Drawn arches on the number line



9.3.4 *Artefacts and Mathematical Meanings*

An artefact is never neutral. It always ‘contains’ the aims and the knowledge of its designers. This is true for both the artefacts coming from the history of mathematics (whose designers are sometimes lost in the mists of time) and the modern artefacts, designed with specific didactical intentions. The design of an artefact depends on the designers’ background knowledge about the mathematics involved and on the intentions about what to mediate. Later, the teachers’ background and intention will determine the classroom use.

9.3.4.1 *Strings with Beads and Arithmetic Racks*

In many pre-schools in Italy, there is a custom/tradition to hang strings with moving beads (similar to Greek worry beads) on the wall to trace the passing of time (e.g. seven beads for a week) or the situation of present/absent pupils (e.g. 28 beads for the whole class). The number of beads on the string depends on the context: 7 beads for a week, 28 beads for the class and so on. The manipulation reminds one of the manipulation of an arithmetic rack (Slavonic abacus) where beads are dragged for counting. But there is a difference: the strings with beads are dependent on the context (7 days in a week; 28 pupils in a class), while the arithmetic rack is decontextualised and can be used to count every small collection. Rather the number of beads depends on the choices made in mathematics, to use base ten to count. In other words, it is a cultural artefact, where culture is here referring to mathematics culture. Even before being introduced to place value, pupils use a rack with ten beads in every line (see Sect. 9.4.1.1). Hence, they may practise counting and notice that when you go to the next row, some kind of language regularity happens: 21, 22, ..., 31, 32 and so on. This approach does not require the convention of substituting one bead with ten beads on another wire (as in other abaci; see Sect. 9.2.2.2) as each bead is a unit. In other words, the collection of beads is similar to tallies (Sect. 9.2.2.1).

9.3.4.2 Artefacts and the Learner's Processes

Each artefact drives the actions of the user and is driven by the user in a coextensive process. This coextensive process changes the users' thinking. This is consistent with the quotation from Vygotsky in Sect. 9.2.1. In that way the design of an artefact influences the way the student will use it, the knowledge a student will learn and internalise while working with the artefact and also the student's image of mathematics. In the process, not only the design of an artefact but also the task and the acting influence the student's processes (see Sect. 9.3).

The arithmetic rack may be improved, with particular mathematical aims. A designer who knows that we are usually able to recognise numbers up to five simultaneously and larger numbers only in a quasi-simultaneous way can colour the balls of the arithmetic rack with a structure of five and also add black and white labels (Fig. 9.13). Such design improvements have been refined over decades and are still visible in some modern artefacts.

The exclusive use of an artefact as an 'object on its own' could lead to sticking with direct modelling activities and using only counting strategies instead of using structural features of an artefact (like a structure by fives and tens) and developing more sophisticated mental calculation strategies.

We use the arithmetic rack as an example. It should support children to replace counting as an arithmetic strategy with more advanced strategies. Children can continue to slide the balls one by one, still counting, whereas it is possible to move several balls at once. The children have to understand at least implicitly what the artefact was made for and to try to follow the intentions of whoever created the artefact. These assumptions about the designer's intentions play an important role in how they should use an artefact, and it is the responsibility of the teacher to guide students in the appropriate use. Therefore, it is essential that the teacher is highly competent in mathematics and mathematics education. He or she is responsible for the right and good choice of an artefact, and is the one who has to show the children how to work with it. To use an artefact in a constructive way, it is necessary for a child to become familiar with the artefact and its structure (see the example of the giant Slavonic abacus for pre-school in Sect. 9.4.1.1). The teacher's instruction is needed (at least for some children) to support the development of mathematical meanings and strategies; so teachers have a role as cultural mediators with respect to mathematical content.

9.3.4.3 From Concrete to Thought Experiment

Whereas 'smaller' numbers (in particular numbers up to 100) can easily be presented as sets of items by artefacts or physical objects, the situation fundamentally changes with bigger numbers (like 123,456). With the extension of the number range, artefacts become less and less important as concrete representations of numbers. Instead, mental 'enlargements' of artefacts are used frequently. For instance, how would one million look like if we use base-ten MAB (Schipper et al. 2000)?

Fig. 9.26 A second grader draws two exemplars of spike abacus close to each other to represent an eight-digit number by juxtaposing them

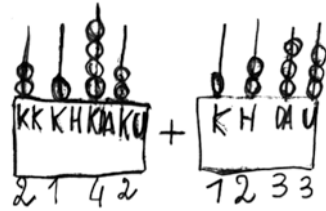

Table 9.1 Four-Phases_Model to support the development of basic computational ideas

Phase 1	Concrete usage of manipulatives and verbalisation of operations
	Teacher and child actively use the material and verbally describe their operations and their meaning. When the child is confident in working with the material, the child takes over and verbalises the operation itself.
Phase 2	Verbal description of the imaginative use of the manipulative in sight
	With the manipulative in sight, the child describes the operations on the manipulative to the teacher or a fellow student who performs the according operations following the child’s descriptions.
Phase 3	Verbal description of the imaginative use of the covered manipulative
	With the manipulative covered by a screen/shield, the child describes the operations on the manipulative to the teacher or a fellow student who performs the according operations following the child’s descriptions.
Phase 4	Verbal description of the mental operation
	The child verbally describes the operations without the manipulative being present in any form other than the child’s imagination. The tasks are given in a symbolic representation

In this case, artefacts tend to be used as manipulatives and auxiliaries for solving calculation problems but rather are used as reference points for English (1997). So, for instance, the steps on the number line are equal for $58 + 37$ and $12,358 + 37$. The wires in a spike abacus may be duplicated to reach thousands and millions (see the representation of a second grader in Fig. 9.26).

A successful teaching and learning process depends on the ability to focus upon the ‘relevant’ aspects of the actions and thereby to link the symbolic representation and the enactive representation (in terms of concrete actions on manipulatives).

A specific *Four-Phases-Model* (see the Table 9.1) to assist the gradual shift from material to mental images was reported by Rottmann and Peter-Koop (2015; cf. Wartha and Schulz 2012) to support the development of mathematical concepts and mental strategies especially for students that experience severe learning difficulties, assisting such internalisation processes. Mental images and representations should increasingly replace concrete actions on manipulatives over time, although working at any single point usually still involves moving between concrete and mental images (Roberts 2015).

This model is based on initial ideas of Bruner and the further development of Bruner’s theory by the Swiss psychologist Aebli (1976). Bruner (1973) distinguished three types of representational systems: the enactive, the iconic and the symbolic representation. While the enactive representation is based upon actions, the iconic representation comprises both, pictures and mental images. The symbolic representation involves mathematical symbols (as written numbers or operation symbols) as well as language. Bruner strongly links learn-

ing processes to translations of one representational system into another. And Aebli in addition describes gradual internalization processes from enactive to mental actions, which focus on the transition from one representation to another.

With emphasis on verbal descriptions of enactive and mental actions, the Four-Phases-Model stresses the relevance to assist the development of mental images by a gradual and systematic removal of the manipulatives. (Rottmann and Peter-Koop 2015, p. 366)

This Four-Phases-Model acknowledges the need for verbal descriptions when using concrete manipulatives and a transitional phase from manipulating with material to mental operations that activate a mental concept which allows the child to imagine the actions required in order to solve an addition or subtraction problem (Electronic Supplementary Material: Rottmann 2017).

9.3.4.4 Not Only Counting

The examples above are mainly based on counting, although there is an intentional shift later towards mental strategies. According to Zhou and Peverly (2005), ‘Overreliance on counting strategies at this age will hinder children’s development of abstract mathematical reasoning abilities’ (p. 265). Surely counting risks putting measuring into the shade (see this volume, Chaps. 13 and 19), but this is not the only possible risk.

An interesting approach in Chinese kindergartens and early primary classrooms was reported (Ni et al. 2010; Cheng 2012). Children are given a multiple-classification task with sets of 2,3,4,5,6,7,8,9 small faces. For instance, children are shown four faces and asked to identify attributes that may be used to classify the faces into different groups. These four faces feature three attributes: one face has a hat and three do not; three happy faces and one angry face; two yellow faces and two red faces.

Teachers ask their students to observe and analyse the attributes and relationships of the four faces. Then, they guide the students’ use of black and white beads to model the relationships as they solve addition and subtraction problems within this universe of 4 (e.g. $1 + 3 = 4$, $3 + 1 = 4$, $2 + 2 = 4$; $4 - 1 = 3$, $4 - 3 = 1$, $4 - 2 = 2$). Next, the students develop their understanding of part-whole relations for the other numbers (from 2 to 10), by doing classification tasks with these numbers. In this way, children are led to practise decomposition in additions and subtractions. They make notes on a 10×10 grid.

This example refers to combinatorial thinking and reasoning (this volume, Chap. 13). The use of a 10×10 grid is consistent with the pattern and structure approach as discussed in this volume (Chap. 7).

The activity of composition/decomposition is described also by Inprasitha (2015) as shown in Fig. 9.27. How many? is an activity for learning decomposition for first grade students. They drop the balls in the box and guess ‘How many are there?’, ‘How many are hidden?’. Then they fill the number of balls on the card with the correct number. For example, drop five balls in the box, and fill two and three balls on the card (Inprasitha 2015). It is also consistent with the activity for first graders practised in China (Fig. 9.28).

Fig. 9.27 The drop-box game extracted from Inprasitha and Isoda (2010)

2 **เท่าไรกับเท่าไร**



①

5

○○○○○

--	--

5

3

2

5 แยกเป็น 3 กับ 2

5

○○○○○

--	--

5

1

4

เติมตัวเลข
ลงใน □
ให้ถูกต้อง



6

○○○○○○

--	--

6

3

3

6

○○○○○○

--	--

6

4

2

6

○○○○○○

--	--

6

1

5

①

26

Fig. 9.28 Activity for first graders (a Chinese textbook)



○○○○

4

/	\
3	1

○○○○

4

/	\
1	3

○○○○

4

/	\
2	2

9.3.5 *Concrete and Virtual Manipulatives*

9.3.5.1 A Possible Contrast

The previous sections have introduced different examples of artefacts, with a special focus on those that are concretely manipulable. In the last decades, the plentiful supply of technologies has fostered the production of virtual manipulatives. The contrast between concrete and virtual artefacts has been addressed in 2009 by Sarama and Clements (2009), who analysed several studies. Their conclusion is that the contrast is not between concrete and virtual manipulatives:

Manipulatives are meaningful for learning only *with respect to learners' activities and thinking*. Physical and computer manipulatives can be useful, but they will be more so when used in comprehensive, well planned, instructional settings. Their physicality is not important – their manipulability and meaningfulness make them educationally effective. In addition, some studies suggest that computer manipulatives can encourage students to make their knowledge explicit [...] but rigorous causal studies have not been conducted to our knowledge. Such research, using randomized control trials, must be conducted to investigate the specific contributions of physical and computer manipulatives to particular aspects of mathematics teaching and learning. (pp. 149–50)

In ICMI Study 17 (Hoyles and Lagrange 2010), only one example of a project for primary school with technologies is described, i.e. the *SYL Project* (Sketchpad for Young Learners, p. 66). A task is reported, i.e. the jump-along activity, for grades 3–5, with jumps along a basic number line on the screen, where students choose different parameters for the number of the jumps and the size of each jump. This project aims at supporting the existing curriculum, reifying the existing teaching practice on the number line.

With a similar aim, a library of virtual manipulatives was created in the USA.⁴ On the home page of the NLVM website, one reads:

The National Library of Virtual Manipulatives (NLVM) is an NSF-supported project that began in 1999 to develop a library of uniquely interactive, web-based virtual manipulatives or concept tutorials, mostly in the form of Java applets, for mathematics instruction (K-12 emphasis). [...] Learning and understanding mathematics, at every level, requires student engagement. Mathematics is not, as has been said, a spectator sport. Too much of current instruction fails to actively involve students. One way to address the problem is through the use of manipulatives, physical objects that help students visualize relationships and applications. We can now use computers to create virtual learning environments to address the same goals.

The view that a virtual manipulative may address the ‘same goal’ as concrete manipulatives may be contentious first, concrete manipulation may be different from mediated manipulation (e.g. by means of a mouse); second, the facilities offered by technologies may allow to produce manipulatives which are not simulations of the concrete ones, but completely new artefacts instead, with their own intentional designs. Some examples follow.

⁴<http://nlvm.usu.edu>

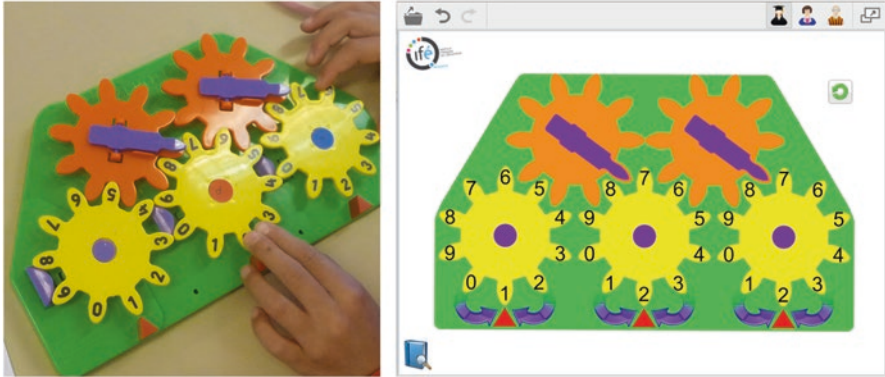
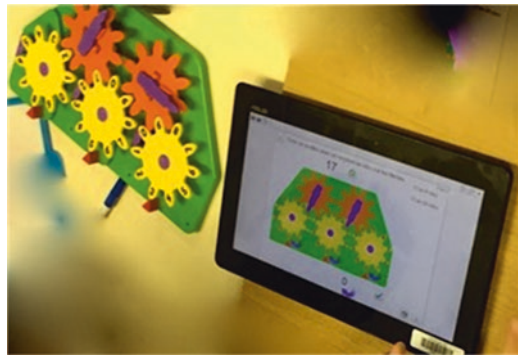

Fig. 9.29 The pascaline (*left*) and the e-pascaline in a Cabri Elem e-book (*right*), both displaying number 122

Fig. 9.30 The tablet version of the e-pascaline



9.3.5.2 The Pascaline and the e-Pascaline

Soury-Lavergne and Maschietto (2015) reported an international experiment, carried out in France and Italy, with a pair of artefacts: a concrete one (pascaline) and a virtual one (e-pascaline). The pascaline (Fig. 9.29, left) is an arithmetic machine made of gears, named after the historical machine of Blaise Pascal, while the e-pascaline (Fig. 9.29, right), developed with the Cabri Elem technology,⁵ is close enough to the pascaline to enable students to transfer some schemes of use (Fig. 9.30).

The pascaline displays three-digit numbers and enables arithmetic operations to be performed. Each of its five wheels has ten teeth and can rotate in two directions. Teeth of the three lower wheels have digits from 0 to 9 and display units, tens and hundreds from the right to the left. The upper wheels automatically drag the lower wheels when needed for place-value notation. The jerky motion of the wheels, rotat-

⁵ <http://educmath.ens-lyon.fr/Educmath/recherche/equipes-associees-13-14/mallete/cabri-elem-logiciels>

ing one tooth at a time, mediates the recursive approach to number, adding or subtracting one unit according to the clockwise or anticlockwise direction. It also links addition and subtraction as inverse operations.

The e-pascaline is close enough to the pascaline to enable students to transfer some schemes of use. Yet it is also different as some procedures with the physical pascaline may be inhibited with the e-pascaline (details in Soury-Lavergne and Maschietto 2015). For instance, the e-pascaline aims to provoke the evolution from the iteration procedure to the decomposition procedure in addition. The two artefacts are combined to help students to overcome some of their limitations and to offer the possibility of a rich experience leading to a flexible understanding of mathematical notions. The e-pascaline may work also on tablets. Using the e-pascaline on tablets (Fig. 9.30), with a touchscreen, gives students a more direct access to the action on the wheels even through the use of the action arrows (Soury-Lavergne and Maschietto 2015). This issue leads us to the further section where multitouch technologies are addressed.

9.3.5.3 Multitouch Technologies

Multitouch technologies introduce new possibility in the design of virtual artefacts. According to Sinclair and Baccaglini-Frank (2015):

With multitouch technology, the interaction becomes more immediate, as the fingers contact the screen directly, either through tapping or a wide variety of gestures. Further, the screen can be touched by multiple users simultaneously at the same time, which invites different types of activity structures than the computer or laptop. [The authors refer to the extended neuroscientific literature pointing to the importance of fingers in the development of number sense and continue as follows.] Basic component abilities that can be powerfully mediated through multi-touch technology are: 1) subitising; 2) one-to-one correspondence between numerosities in analogical form and fingers placed on screen/raised simultaneously/counting with fingers, and in general finger gnosis; 3) fine motor abilities; and, 4) the part-whole concept. (p. 670)

Some examples below indicate the potentialities of multitouch technologies.

TouchCounts is an iPad app (designed by Nathalie Sinclair) where children use their fingers, eyes and ears to learn to count, add and subtract. By using simple gestures to create and manipulate their own numbers, children develop a strong number sense at least for some early steps. *TouchCounts* is aimed at the use of fingers in order to positively affect the formation of number sense and thus also the development of calculation skills. There are two sub-applications in *TouchCounts*, one for counting (1, 2, 3, ...) and the other for operations (addition and subtraction). In the former the first tap produces a disc containing the numeral '1'. Subsequent taps produce sequentially numbered discs. In the latter, children create arbitrary whole numbers and explore basic number operation concepts by pushing (squeezing) numbers together (into new, larger numbers) or by splitting numbers apart (into new, smaller numbers). The strong relationship between fingers and numbers has the potential to address the issue of *finger gnosis* (literally 'finger knowledge'),

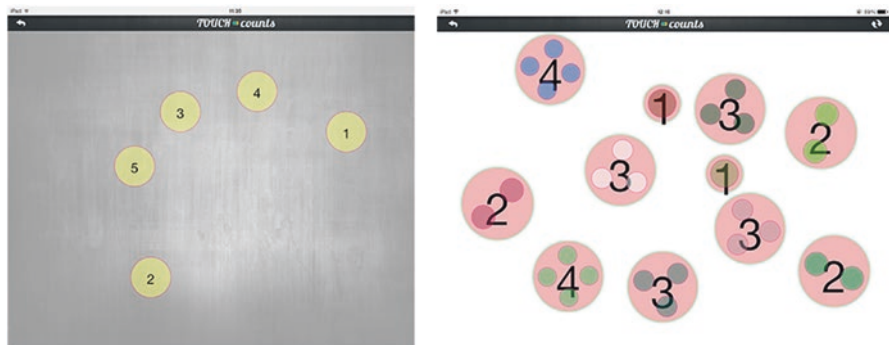

Fig. 9.31 TouchCounts

defined as the ability to differentiate one's own fingers without any visual clues when they are touched (Sinclair and Pimm 2014) (Fig. 9.31).

For *subitising* (Sect. 7.1.1), Baccaglioni-Frank and Maracci (2015) analyse other apps: *Ladybug Count*⁶ and *Fingu*⁷ drawing on a study carried out in a public pre-school in Northern Italy. The study is based on the analysis of children's interactions with these apps in the context of a sequence of activities centred on the use of the iPad. The activity fosters subitising that is the ability to quickly identify the number of items in a small set without counting.

Ladybug Count (finger mode) shows the top view of a ladybug sitting on a leaf, and the aim of each playing turn is to make the ladybug walk off the leaf. This happens when the child places on the screen (in any position) as many fingers as the dots that are on the ladybug's back. *Fingu* shows a room in which different kinds of floating fruits appear. The objects appear in one group or in two groups that float independently, but within each group the arrangement of the objects remains unvaried. The child has to place on the screen, simultaneously, as many fingers as the objects that are floating within a given amount of time. With these activities the ability to use fingers to represent numbers in an analogical format is fostered (Fig. 9.32).

Stellenwerttafel (place value chart) is a dynamic place value chart designed as an app for the iPad by Ulrich Kortenkamp.⁸ It enables children to create tokens in a place value chart and to drag them between places. When moving a token from a place to another, the unbundling and bundling are carried out automatically. Simultaneously the token counts are displayed in the title bar (Fig. 9.33).

The behaviour of the virtual manipulation has no equivalence in the manipulation of physical MABs (see Sect. 9.3.1). MABs for units and tens are different objects (a small cube vs a column of ten small cubes).

⁶<https://itunes.apple.com/us/app/ladybug-count/id443930696?mt=8>

⁷<https://itunes.apple.com/en/app/fingu/id449815506?mt=8>

⁸<https://itunes.apple.com/de/app/stellenwerttafel/id568750442?mt=8>

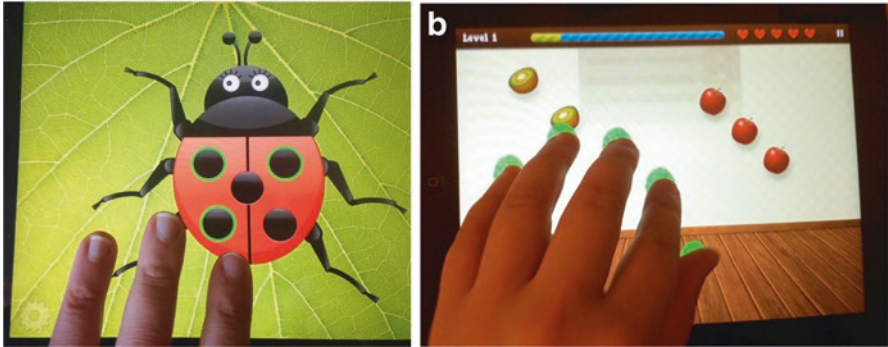
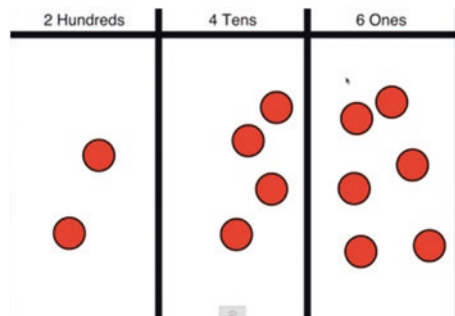

Fig. 9.32 Ladybug Count (left) and Fingu (right)

Fig. 9.33 Stellenwerttafel (place value chart)



Ladel and Kortenkamp (2015) have tested the use of MAB and Stellenwerttafel to build a didactical sequence for a flexible understanding of place value, in order to be able to switch between different possibilities to split a whole in parts where the parts are multiples of powers of ten. The path consists of three steps:

In step one, the child is bundling and unbundling with base ten blocks and learns that there are ones and tens and that 10 ones have the same value as 1 ten. In step two, we introduce the place value chart with the bundling material in the title bar. The amount of ones and tens has to be illustrated by homogeneous counters (or tokens) like tally marks or points. The children learn that if the counters are homogeneous and they want to change the place they have to bundle or unbundle. In that way they connect bundling and place value by bundling in the place value chart. In step three, the children only move the counters and experience the bundling and unbundling by an automatic multiplication and division of the counters. This automation can only be provided by special virtual manipulatives. (Ladel and Kortenkamp 2015, p. 325)

This gallery of examples is by no means exhaustive. This is really a new avenue which has also the potential to be useful for low achievers.

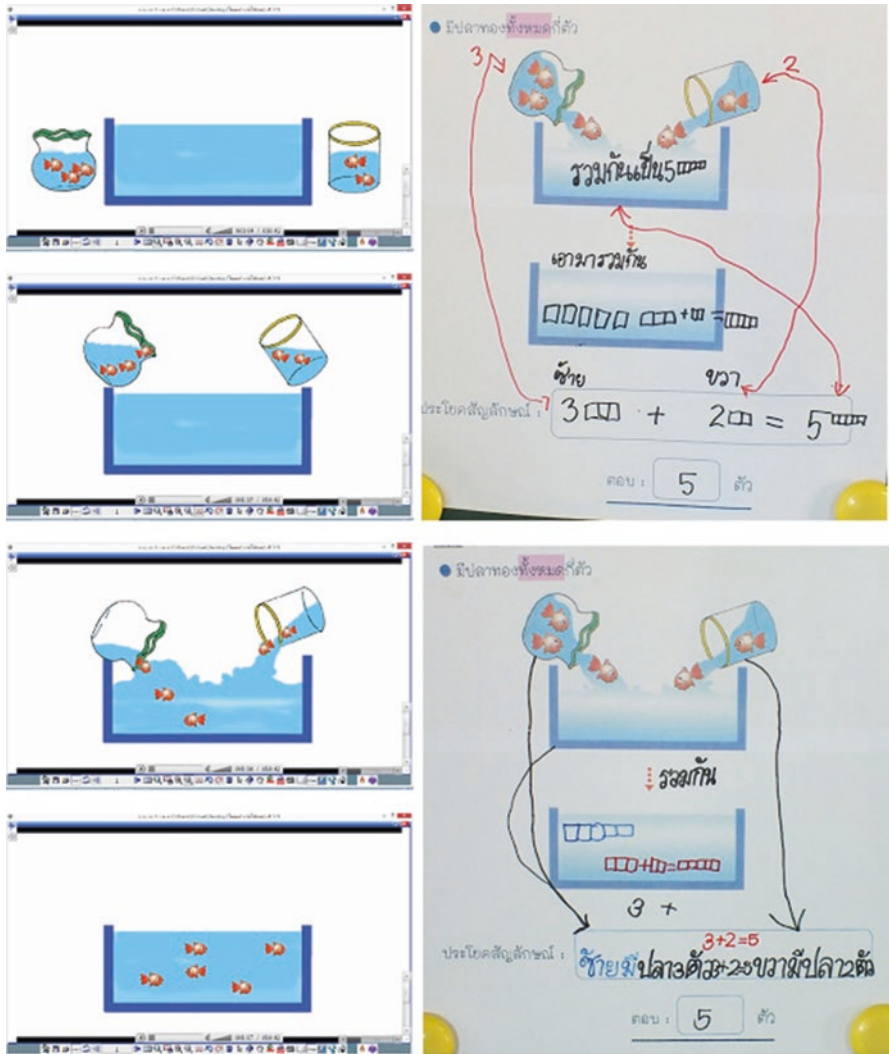

Fig. 9.34 An image from a d-book with students' drawings

9.3.5.4 Digital Textbooks

Further development in the field of digital technologies is expected in the near future. We can mention, for instance, the potential of *d-books* (*digital textbooks*⁹), developed at the University of Tsukuba, for the APEC Lesson Study Project. Digital textbooks can be created by importing existing textbooks as image files. Furthermore, interactive drawing tools can be embedded in the digital textbooks. The textbook data, together with the drawing tools, can be used interactively in classrooms. An example for primary school is Inprasitha and Jai-on (2016); see Fig. 9.34.

⁹http://math-info.criced.tsukuba.ac.jp/software/dbook/dbook_eng

9.4 Mathematical Tasks

Artefacts have the potential to foster students' construction of mathematical concepts in WNA. This potential, connected with both designers' and teachers' background and intentions, may be fulfilled by the activity. Hence, mathematical tasks come to the foreground. Some time in the working group was devoted to the discussion of task. The theme is very large, as a whole study on task design has been realised (Watson and Ohtani 2015). In this section, only a few examples are reported.

9.4.1 *Cognitively Demanding Tasks*

Doyle (1988 cited in Shimizu and Watanabe 2010) argues that tasks with different cognitive demands are likely to induce different kinds of learning. Mathematics tasks are important vehicles for classroom instruction that aim to enhance students' learning. To achieve quality mathematics instruction, then, the role of mathematical tasks to stimulate students' cognitive processes is crucial (Hiebert and Wearne 1993).

Kaur (2010) classified levels of cognitive demands in mathematical tasks by adapting from Stein and Smith (1998, Table 9.2).

The very high level is problem-solving, that is, the heart of mathematics. For instance, it is one of the fundamental processes in the NCTM Standards.¹⁰ In Japan, the problem-solving approach is the preferred method for achieving the objective of teaching (Isoda 2012). Some examples of problem-solving tasks are reported in the following, using different kinds of artefacts, concrete ones (the giant Slavonic abacus) and textual ones with images and texts.

Table 9.2 Levels of cognitive demands

Levels of cognitive demand	Characteristics of tasks
Level 0 – [very low] memorisation tasks	Reproduction of facts, rules, formulas No explanations required
Level 1 – [low] procedural tasks without connections	Algorithmic in nature Focused on producing correct answers Typical textbook word – problems No explanations required
Level 2 – [high] procedural tasks with connections	Algorithmic in nature Has a meaningful/'real-world' context Explanations required
Level 3 – [very high] problem-solving/doing mathematics	Non-algorithmic in nature; requires understanding of mathematical concepts and application of Has a 'real-world' context/a mathematical structure Explanations required

¹⁰<http://www.nctm.org/Standards-and-Positions/Principles-and-Standards/Process/>

Fig. 9.35 Young children counting the beads of a giant Slavonic abacus (<http://memoesperienze.comune.modena.it/bambini/index.htm>)



9.4.1.1 Example: The Big Size Slavonic Abacus

We start with a short example concerning the exploration of an artefact (a giant Slavonic abacus) by pre-school students.

A big-size Slavonic abacus (Fig. 9.35; see also Sect. 9.2.2.2) with 40 beads has been introduced into more than 20 pre-schools in Modena (Italy) in the project *Bambini che contano* (Counting children, see Bartolini Bussi 2013). The way to explore it, agreed with the teachers, is based on the following questions, each of which asks the pupils to take a different perspective:

Task 1: The first impact (the narrator perspective). *What is it? Have you seen it before? What's its name?*

Task 2: The structure of the artefact (the constructor perspective). *How is it made? What do we need to build another one? How to give instructions to build another one?*

Task 3: The use of the artefact (the user perspective) to fulfil a task while playing skittles or counting the present children and similar. *How do you use it to keep the score? How do you use it during the call?*

Task 4: The justification for use (the mathematician perspective). *Why does it work to keep score?* and similar.

Task 5: New problems (the problem-solver perspective). As this Slavonic abacus contains only four lines (40 beads). *What to do if we needed more?*

The last task highlights that an artefact may be used even in situations that go beyond its capabilities. We might consider some hypothetical artefacts through thought experiments, which may transfer the mathematical meaning into areas that are out of reach of the original artefacts. In particular, in the example above, the children added a new line on the floor with small blocks, in order to simulate an additional line to count up to 50, if needed.

9.4.1.2 Example: A Combinatorial Task with Cuisenaire Rods

Ball and Bass (2015) have described a *demanding combinatorial task for disadvantaged students*, ‘to find an order in which to list the five numbers 1,2,3,4 and 5, without repetition, in such a way that when subsets of adjacent numbers in the specific list are added together, every number, from the smallest to the largest, is possible’ (p. 292). The majority of students are economically disadvantaged fifth graders. This abstract task is given to the students in a story called ‘the train problem’ where Cuisenaire rods (see Sect. 9.3.1.1) are used to represent cars on a ‘train’. The goal of this task that is neither traditional nor standard is to encourage the experience of mathematical perseverance in solving a problem about WNA. This kind of attitude is supposed to be very important for low achievers and disadvantaged students. Other studies address motivation and learning strategies as long-term predictors of growth (Murayama et al. 2013).

9.4.1.3 Example: A Combinatorial Task with Digits

Bass suggested a *combinatorial task with digits*: Using the numbers 1, 3 and 4, each one exactly once:

- Find all the three-digit numbers you can make. How do you know that you have them all?
- Which one is largest? Smallest? How do you know?
- Which pair of them is closest together? How do you know?
- Find the sum (or the average) of all of these numbers. Can you find clever ways to do this?

9.4.1.4 Example: A Combinatorial Task on Paper and Pencil

Bass suggested another combinatorial task. In this 3×3 grid square, colour three of the little squares blue so that there is exactly one blue square in each row and in each column. How many ways are there to do this? How do you know that you have found them all (Fig. 9.36)?

9.4.1.5 Example: Finding Patterns on the Calendar

The calendar of October 2015 looks like the one in Fig. 9.37. The shaded part is an example of what we will call a ‘square of days’. If we have any square of days, we can calculate the number $bc - ad$. Try a few examples. Do you notice any pattern? Do you think this is always true? If so, can you explain why? Would the same thing be true for other months?

Fig. 9.36 A 3×3 grid square

Sun	Mon	Tue	Wed	Thu	Fri	Sat
				1	2	3
4	5	6	7	8	9	10
11	12	13	14	15	16	17
18	19	20	21	22	23	24
25	26	27	28	29	30	31

Fig. 9.37 The calendar

None of these examples involves a pure memorisation of procedure task. They are very high-level tasks which can be posed in pre-primary and primary school. Other examples of cognitively demanding tasks may be found in recreational mathematics (Sect. 9.2.2.6).

9.5 Artefacts and Tasks in the Institutional and Cultural Context

In the previous sections, we have considered separately artefacts (Sects. 9.2 and 9.3) and tasks (Sect. 9.4), although it is evident that they are an inseparable pair. An artefact is usually explored to contend with a mathematical task; a mathematical task is

Table 9.3 Number ranges within grades 1–4

Grade	Asia: Mainland China	Africa: Kenya	Australia	Europe: Germany	North America: USA
1	100	99	100	20	100
2	10,000	999	1000	100	1000
3	> 10,000	9999	10,000	1000	1000
4	100,000,000	99,999	>10,000	1,000,000	1,000,000

performed by some artefact (including language, text or concrete or virtual objects). In the theory of semiotic mediation (Sect. 9.2.1.2), artefacts and tasks are, together with mathematics knowledge, the element of the design process and the starting point of classroom activity. But artefacts and tasks strongly depend on the cultural and institutional constraints that determine the mathematics that is taught (Chevallard and Bosch 2014).

9.5.1 Institutional Constraints: The Number Range

The number range, in school, contributes to define the feature of tasks in WNA. It is an internationally shared approach to start with small numbers and to extend the number range in steps. In detail and application, however, there are considerable differences between countries. Examples from countries of five different continents are given in Table 9.3 (MOEST 2002; MSW 2008; CCSSO 2016; MOE 2011a, b; ACARA 2013).

While children in the other countries deal with numbers up to 100 (or 99), in Germany the focus is on understanding numbers up to 20 and on the development of addition and subtraction strategies within this number range. Although bigger numbers are used in grade 1, in some countries calculation strategies are emphasised later or are focused on numbers up to 20 or at most on special types of problems with bigger numbers (e.g. in Australia and in the USA; cf. Peter-Koop et al. 2015). By contrast, in Germany a strong tendency exists towards using the same number range both for calculation and for other activities (such as representing, composing and decomposing numbers). Tasks in textbooks and in the classrooms are usually designed according to the number range. Kenya and Australia usually use numbers (approximately) ten times bigger than in the previous grade.

Some research studies indicate considerable differences in children's whole number knowledge after completing the first grade in different countries. In a comparison of 7-year-old Australian and German children, Peter-Koop et al. (2015) refer to greater knowledge of counting and place value ideas for Australian students, whereas German children appear to develop more advanced calculating strategies. A follow-up comparison of the same children at the end of grade 2, however, indicates the same level of knowledge, especially in understanding the place value system.

9.5.2 *Cultural Constraints: Language Transparency*

Table 9.3 shows an incredible continuing gap between the Chinese situation and the others. It is likely that the number range for early grades is linked in a dialectical way to the most common artefacts (including abaci and language). For instance, most artefacts for place value described in the previous sections are able to represent numbers with at the utmost three (or four) digits, while the number of wires in *suàn pán* (算盘) are many more. In accordance with this, in China the number range increases faster. It is likely that there is a connection between the transparency of Chinese wording of number according to place value (this volume, Chap. 3), the faster increase of number size in primary grades and the available artefacts for representing numbers and computing.

The familiarity with big numbers in early grades does not necessarily increase the possibility of coping with more demanding mathematical tasks. According to Ni (2015):

The strengths of Chinese children's mathematics proficiency are accompanied with notable weakness. For example, there could be an inherent problem with the curriculum system in the basic approach to mathematics thinking. Factors such as trial and error, induction, imagination and hypothesis testing are not significant part of mathematics curriculum and instruction. Probably as a consequence, for example, Chinese students appeared less tolerant for ambiguity in mathematics classroom, less willing to take risks when solving mathematical problems. The interest and confidence in learning mathematics of Chinese students was shown to deteriorate over the years as they moved up to higher grades. (p. 343)

The transparency of language may be not the only important variable. A similar issue was addressed, in a very different context, by Young-Loveridge and Bicknell (2015), who reported that, in a study about place value in New Zealand, Maori students did not perform as well as either of the other groups:

Although the counting words used in the Maori language have a transparent decade structure, only children who are taught through the medium of Maori develop the fluency to speak and think in the Maori language. In reality, many teachers and students learn Maori as a second language, rather than being truly bilingual. (p. 383)

A further study (Theodore et al. 2015) added more results about this issue:

We found that more Maori graduates were females than males. Previous research has also shown that Maori males are less likely to gain both tertiary and school qualifications compared to Maori females and non-Maori students, suggesting that disparities in educational participation begin early. Identified barriers to participation include lack of cultural responsiveness, difficulties transitioning from primary to secondary schooling and lower expectations of students. There were also differences found in what (e.g., commerce) and how (e.g., full-time status) Maori males studied compared to Maori females. (p. 10)

The quoted studies show that focusing only on language transparency is not enough to interpret results of research work.

9.5.3 *Cultural Constraints: Bilingual Communities*

Linguistic issues have been addressed by the ICMI Study 21 (Barwell et al. 2015), where specific chapters are devoted to the problems of students with the school language different from everyday language. A direct account of similar problems were discussed in the group by Veronica Sarungi (personal communication) who reported about the situation in Tanzania and other close countries (for a deeper discussion of this issue, see this volume, Chap. 3):

The issue around language and the learning of whole numbers in Tanzania and other East African countries is complex. The diversity in the first language of learners makes teaching of mathematics in learners' first language difficult. For example, Tanzania has over 120 ethnic tribes with their own language, although these belong to major language groups such as Bantu, Nilotic and Cushitic.

Verbal language is sometimes not the best artefact to be used in classrooms. A study (Miller and Warren 2014) has analysed the performance of Australian students from disadvantaged contexts (in most cases with English as second language) showing that low performance on national numeracy testing can be overcome with a programme that focuses on specific mathematical language with rich figural representations. The importance of figural representation for Australian aboriginal children was highlighted also by Butterworth in the plenary sessions of the Conference (see also Butterworth et al. 2008; this volume Chap. 20).

9.6 Concluding Remarks: Future Challenges

In the group discussion, different designers' or teachers' intentions were identified to explain or orient the choices of the pair artefact and task. The following list is expressed in positive terms, meaning that paying attention to each issue may foster learning, while not paying attention to some issues may hinder learning. This is by no means exhaustive, but highlights some shared beliefs of the participants in the group discussion.

Epistemological Issues In this case, the mathematical consistency is in the foreground: promote students' personal reconstruction of elementary arithmetic; promote students' engagement in meaningful mathematics; promote students' flexibility between different modes of representation; promote insight.

Cognitive Issues In this case, the students' processes are in the foreground: make the maths more familiar and more user-friendly; assist mathematical inquiry, exploration, defining and proving; foster body involvement such as counting with the fingers or jumping on the number line.

Affective Issues In this case, the students' motivations and beliefs are in the foreground: create motivating learning environments; encourage, support and develop perseverance.

In this chapter we have addressed some aspects that affect whole number learning, offering examples of artefacts and mathematical tasks that may foster or hinder learning of WNA. We have collected a rich (although not complete) gallery of cultural artefacts and of teaching aids, including several realised by means of virtual technologies, and we have offered some examples of mathematical tasks concerning WNA. *Artefacts and tasks have to be considered as an inseparable pair within a given cultural and institutional context.*

We have mentioned some features of languages and cultures that sometimes hide mathematical meanings and produce the risks of didactical obstacles. The cultural roots of the epistemological obstacle represented by classical additive systems for the development of place value have been discussed.

The map is very complex. Future challenges seem to be related to teacher education. Two specific programmes for pre-primary and primary teacher education have been discussed in the working group (see Sect. 9.1.1.3), one from Canada and one from Thailand. The way of coping with epistemological and cultural issues in either programme has enriched the discussion, forcing the participants to wonder every time how teachers might cope with the complexity of designing and implementing in the classrooms teaching and learning of WNA, keeping account of the peculiar language and cultural constraints. This issue was always in the background of the discussion, although a specific panel in the Conference (this volume, Chap. 17) addresses teacher education and development.

References

- Aebli, H. (1976). *Psychologische Didaktik-Didaktische Auswertungen der Psychologie von Jean Piaget*. Stuttgart: Klett-Cotta.
- Australian Curriculum Assessment and Reporting Authority. (2013). *The Australian curriculum: Mathematics v2.4*. Retrieved March 17, 2013, <http://www.australiancurriculum.edu.au/Mathematics/Curriculum/F-10>
- Baccaglioni-Frank, A., & Maracci, M. (2015). Multi-touch technology and preschoolers' development of number-sense. *Digital Experiences in Mathematics Education*, 1(1), 7–27.
- Baccaglioni-Frank, A., Hoyles, C., & Noss, R. (2014, September 21–26). From notable occurrences to situated abstractions: A window for analysing learners' thinking-in-change in a microworld. In *Proceedings of the 12th international conference of the mathematics education into the 21st century project: The future of mathematics education in a connected world*. Montenegro.
- Bartolini Bussi, M. G. (2011). Artefacts and utilization schemes in mathematics teacher education: Place value in early childhood education. *Journal of Mathematics Teacher Education*, 14(2), 93–112.
- Bartolini Bussi, M. G. (2013). Bambini che contano: A long-term program for preschool teachers' development. In B. Ubuz, et al. (Eds.), *CERME 8. Proceedings of the eight congress of the European Society of Research in Mathematics Education*, (pp. 2088–2097). Ankara: Middle East Technical University.

- Bartolini Bussi, M. G., & Mariotti, M. A. (2008). Semiotic mediation in the mathematics classroom: Artefacts and signs after a Vygotskian perspective. In L. English, M. Bartolini Bussi, G. Jones, R. Lesh, B. Sriraman, & D. Tirosh (Eds.), *Handbook of international research in mathematics education* (2nd ed., pp. 746–783). New York: Routledge Taylor & Francis Group.
- Bartolini Bussi, M. G., & Martignone, F. (2014). Manipulatives in mathematics education. In S. Lerman (Ed.), *Encyclopedia of mathematics education* (pp. 365–372). Dordrecht: Springer.
- Barwell, R., Clarkson, P., Halai, A., Kazima, M., Moschkovich, J., Planas, N., Setati, M., Valero, P., & Villavicencio Ubillús, M. (2015). *Mathematics education and language diversity. The 21st ICMI study* (New ICMI Studies Series). New York/Berlin: Springer.
- Bruner, J. S. (1973). *The relevance of education*. New York: Norton.
- Butterworth, B., Reeve, R., Reynolds, F., & Lloyd, D. (2008). Numerical thought with and without words: Evidence from indigenous Australian children. *Proceedings of the National Academy of Sciences of the United States of America*, 105(35), 13179–13184.
- Cheng, Z. J. (2012). Teaching young children decomposition strategies to solve addition problems: An experimental study. *The Journal of Mathematical Behavior*, 31, 29–47.
- Chevallard, Y., & Bosch, M. (2014). Didactic transposition in mathematics education. In S. Lerman (Ed.), *Encyclopedia of mathematics education* (pp. 170–174). Dordrecht: Springer.
- Cole, M. (1996). *Cultural psychology. A once and future discipline*. Cambridge, MA: The Belknap Press.
- Conti, A. (1920). *Aritmetica per la prima classe elementare*, Firenze: Bemporad e Figlio. Retrieved from <http://www.indire.it/archivi/dia>
- D'Amore, B., Radford, L., & Bagni, G. (2016). Obstáculos epistemológicos y perspectiva socio-cultural de la matemática. In B. D'Amore & L. Radford (Eds.), *Enseñanza y aprendizaje de las matemáticas: Problemas semióticos, epistemológicos y prácticos* (pp. 167–194). Bogotá: Editorial Universidad Distrital Francisco José de Caldas.
- Dienes, Z. P. (1963). *An experimental study of mathematics learning*. London: Hutchinson.
- Dong-Joong, K., Ferrini-Mundy, J., & Sfard, A. (2012). How does language impact the learning of mathematics? Comparison of English and Korean speaking university students' discourses on infinity. *International Journal of Educational Research*, 51/52, 86–108.
- Engeström, Y. (1987). *Learning by expanding: An activity-theoretical approach to developmental research*. Helsinki: Orienta-Konsultit.
- English, L. (Ed.). (1997). *Mathematical reasoning: Analogies, metaphors, and images*. Mahwah: Lawrence Erlbaum Associates.
- Fauvel, J., & van Maanen, J. (Eds.). (2000). *History in mathematics education. The ICMI study*. Dordrecht: Kluwer.
- Hiebert, J., & Wearne, D. (1993). Instructional tasks, classroom discourse, and students' learning in second-grade arithmetic. *American Educational Research Journal*, 30(2), 393–425.
- Hoyle, C., & Lagrange, J. B. (Eds.). (2010). *Mathematics education and technology-rethinking the terrain. The 17th ICMI study*. New York: Springer.
- Inprasitha, M., & Isoda, M. (eds). (2010). *Study with your friends: Mathematics for elementary school 1st grade*. Khon Kaen: Klungnanawittaya. (In Thai).
- Inprasitha, M., & Jai-on, K. (2016). *The potential of dbook Pro to teach whole number arithmetic*. [Online]. Retrieved on March 16, 2016, from: <http://www.crme.kku.ac.th/The potential of dbookPro Exemplar 3+2>
- Isoda, M. (2012). Problem-solving approach to develop mathematical thinking. In Isoda, M. & Katagiri, S. (Eds.), *Monographs on lesson study for teaching mathematics and sciences—Vol. 1: Mathematical thinking-how to develop it in the classroom*. (pp. 1–28). Singapore: World Scientific.
- Jacobsen, L. E. (1983). Use of knotted string accounting records in old Hawaii and ancient China. *The Accounting Historians Journal*, 10(2), 53–62.
- Karp, A., & Schubring, G. (Eds.). (2014). *Handbook on the history of mathematics education*. New York: Springer.

- Kaur, B. (2010). A study of mathematical task from three classrooms in Singapore. In Y. Shimizu, B. Kaur, R. Huang, & D. J. Clarke (Eds.), *Mathematical tasks in classrooms around the world* (pp. 15–33). Rotterdam: Sense Publishers.
- Kempinsky, H. (1921). *So rechnen wir bis hundert und darüber hinaus. Eine Anleitung für den Rechenunterricht besonders des zweiten Schuljahres*. Leipzig: Verlag der Dürr'schen Buchhandlung.
- Kordemsky, B. A. (1992). *The Moscow puzzles: 359 mathematical recreations*. New York: Dover.
- Lam, L. Y., & Ang, T. S. (2004). *Fleeting footsteps: Tracing the conception of arithmetic and algebra in ancient China*. Singapore: World Scientific.
- Meaney, T., Trinick, T., & Fairhall, U. (2012). *Collaborating to meet language challenges in indigenous mathematics classrooms*. New York: Springer.
- Menninger, K. (1969). *Number words and number symbols: A cultural history of numbers*. Cambridge, MA: The MIT Press. (Translated from the German edition of 1958).
- Miller, J., & Warren, E. (2014). Exploring ESL students' understanding of mathematics in the early years: Factors that make a difference. *Mathematics Education Research Journal*, 26(4), 791–810.
- Ministerium für Schule und Weiterbildung des Landes Nordrhein-Westfalen (MSW NRW). (2008). *Richtlinien und Lehrpläne für die Grundschule in Nordrhein-Westfalen. Mathematik*. Frechen: Ritterbach.
- Ministry of Education Science and Technology (MOEST). (2002). *Primary education syllabus: Volume two*. Nairobi: Kenya Institute of Education.
- Monaghan, J., Trouche, L., & Borwein, J. (2016). *Tools and mathematics. Instruments for learning*. New York: Springer.
- Murayama, K., Pekrun, R., Lichtenfeld, S., & vom Hofe, R. (2013). Predicting long-term growth in students' mathematics achievement: The unique contributions of motivation and cognitive strategies. *Child Development*, 84(4), 1475–1490.
- Ni, Y. J., Chiu, M. M., & Cheng, Z. J. (2010). Chinese children learning mathematics: From home to school. In M. H. Bond (Ed.), *The Oxford handbook of Chinese psychology* (pp. 143–154). Oxford: Oxford University Press.
- Nührenböcker, M., & Steinbring, H. (2008). Manipulatives as tools in teacher education. In D. Tirosh & T. Wood (Eds.), *Tools and processes in mathematics teacher education. Volume 2 of The international handbook of mathematics teacher education* (pp. 157–182). Rotterdam: Sense Publishers.
- Rabardel, R. (1995). *Les hommes et les technologies. Approche cognitive des instruments contemporains*. Paris: Armand Colin.
- Radford, L. (1997). On psychology, historical epistemology and the teaching of mathematics: Towards a socio-cultural history of mathematics. *For the Learning of Mathematics*, 17(1), 26–33.
- Rieber, R. W., & Wollock, J. (1997). The instrumental method in psychology. In R. W. Rieber & J. Wollock (Eds.), *The collected works of L. S. Vygotsky: Problems of the theory and history of psychology* (pp. 85–89). Boston: Springer.
- Sarama, J., & Clements, D. H. (2009). "Concrete" computer manipulatives in mathematics education. *Child Development Perspectives*, 3(3), 145–150.
- Schipper, W., Dröge, D., & Ebeling, A. (2000). *Handbuch für den Mathematikunterricht, 4. Schuljahr*. Hannover: Schroedel.
- Shimizu, S., & Watanabe, T. (2010). Principles and processes for publishing textbooks and alignment with standards: A case in Japan. Paper presented at the *APEC conference on replicating exemplary practices in mathematics education 2010*, Koh Samul: Suratthani.
- Sierpinska, A. (1996). *Understanding in mathematics*. London: Falmer Press.
- Sinclair, N., & Baccaglioni-Frank, A. (2015). Digital technologies in the early primary school classroom. In L. English & D. Kirshner (Eds.), *Handbook of international research in mathematics education: Third edition* (pp. 662–686). Taylor and Francis.
- Sinclair, N., & Pimm, D. (2014). Number's subtle touch: Expanding finger gnosis in the era of multi-touch technologies. In P. Liljedahl, C. Nicol, S. Oesterle, & D. Allan (Eds.), *Proceedings*

- of the 38th conference of the International Group for the Psychology of Mathematics Education* (Vol. 5, pp. 209–216), Vancouver BC: PME.
- Stacey, K., Helme, S., Shona Archer, S., & Caroline Condon, C. (2001). The effect of epistemic fidelity and accessibility on teaching with physical materials: A comparison of two models for teaching decimal numeration. *Educational Studies in Mathematics*, 47(2), 199–221.
- Stetsenko, A. (2008). From relational ontology to transformative activist stance on development and learning: Expanding Vygotsky's (CHAT) project. *Cultural Studies of Science Education*, 3(2), 471–491.
- Stein, M. K., & Smith, M. S. (1998). Mathematical tasks as a framework for reflection: From research to practice. *Mathematics Teaching in the Middle School*, 3(4), 268–275.
- Tahan, M. (1996). *O omem que calculava*. Rio de Janeiro: Grupo Editorial Record.
- The Council of Chief State School Officers (CCSSO). (2016). National Governors Association Center for Best Practices and Council of Chief State School Officers. *Common core state standards for mathematics*. Retrieved March 20, 2016. <http://www.corestandards.org/Math/>
- The Ministry of Education. (2011a). *Syllabus for the teaching of primary mathematics of the nine-year compulsory education*. 北京:北京师范大学出版社. Beijing: Beijing Normal University Press. (in Chinese).
- The Ministry of Education. (2011b). *Guidelines of mathematics curriculum for 9-year compulsory education*. <基础教育课程改革纲要>. 北京:北京师范大学出版社. Beijing: People's Education Publishing. (in Chinese).
- Theodore, R., Trustin, K., Kiro, C., Gollop, M., Taumoepeau, M., Taylor, N., Chee, K. S., Hunter, J., & Poulton, R. (2015, November). Maori university graduates: Indigenous participation in higher education. *Higher Education Research & Development*, 2015, 1–15. <https://doi.org/10.1080/07294360.2015.1107883>
- Uttal, D. H., Scudder, K. V., & DeLoache, J. S. (1997). Manipulatives as symbols: A new perspective on the use of concrete objects to teach mathematics. *Journal of Applied Developmental Psychology*, 18(1), 37–54.
- Watson, A., & Ohtani, M. (Eds.) (2015). *Task design in mathematics education. The 22nd ICMI study*. New York: Springer.
- Wartha, S., & Schulz, A. (2012). *Rechenproblemen vorbeugen*. Berlin: Cornelsen.
- Xie, X., & Carspecken, P. F. (2007). *Philosophy, learning and the mathematics curriculum dialectical materialism and pragmatism related to Chinese and American mathematics curriculums*. Rotterdam: Sense Publishers.
- Zaslavsky, C. (1973). *Africa counts: Number and pattern in African cultures*. Chicago: Lawrence Hill Books.
- Zhou, Z., & Peverly, S. (2005). Teaching addition and subtraction to first graders: A Chinese perspective. *Psychology in the Schools*, 42(3), 259–272.

Cited papers from Sun, X., Kaur, B., & Novotna, J. (Eds.). (2015). Conference proceedings of the ICMI study 23: Primary mathematics study on whole numbers. Retrieved February 10, 2016, from www.umac.mo/fed/ICMI23/doc/Proceedings_ICMI_STUDY_23_final.pdf

- Bakker, M., van den Heuvel-Panhuizen, M., & Robitzsch, A. (2015). Learning multiplicative reasoning by playing computer games (pp. 282–289).
- Baldin, Y., Mandarino, M. C., Mattos, F. R., & Guimarães, L. C. (2015). A Brazilian project for teachers of primary education: Case of whole numbers (pp. 510–517).

- Ball, D. L., & Bass, H. (2015). Helping students learn to persevere with challenging mathematics (pp. 379–386).
- Bartolini Bussi, M. G. (2015). The number line: A “western” teaching aid (pp. 298–306).
- Cao, Y., Li, X., & Zou, H. (2015). Characteristics of multiplication teaching of whole numbers in china: The application of nine times table (pp. 423–430).
- González, S., & Caraballo, J. (2015). Native American cultures tradition to whole number arithmetic (pp. 92–98).
- Hodgson, B. R., & Lajoie, C. (2015). The preparation of teachers in arithmetic: A mathematical and didactical approach (pp. 307–314).
- Inprasitha, M. (2015). An open approach incorporating lesson study: An innovation for teaching whole number arithmetic (pp. 315–322).
- Ladel, S., & Kortenkamp, U. (2015). Development of conceptual understanding of place value (pp. 323–330).
- Mercier, A., & Quilio, S. (2015). The efficiency of primary level mathematics teaching in French-speaking countries: A synthesis (pp. 331–338).
- Ni, Y. J. (2015). How the Chinese methods produce arithmetic proficiency in children (pp. 341–342).
- Peter-Koop, A., Kollhoff, S., Gervasoni, A., & Parish, L. (2015). Comparing the development of Australian and German children’s whole number knowledge (pp. 346–353).
- Pimm, D., & Sinclair, N. (2015). The ordinal and the fractional: Some remarks on a trans-linguistic study (pp. 354–361).
- Roberts, N. (2015). Interpreting children’s representations of whole number additive relations in the early grades (pp. 243–250).
- Rottmann, T., & Peter-Koop, A. (2015). Difficulties with whole number learning and respective teaching strategies (pp. 362–370).
- Siu, M. K. (2015). Pedagogical lessons from *Tongwen Suanzhi* (同文算指) – Transmission of *bisuan* (笔算 written calculation) in China (pp. 132–139).
- Soury-Lavergne, S., & Maschietto, M. (2015). Number system and computation with a duo of artifacts: The pascaline and the e-pascaline (pp. 371–378).
- Sun, X. (2015). Chinese core tradition to whole number arithmetic (pp. 140–148).
- Young-Loveridge, J., & Bicknell, B. (2015). Using multiplication and division contexts to build place-value understanding (pp. 379–386).
- Zou, D. (2015). Whole number in ancient Chinese civilisation: A survey based on the system of counting-units and the expressions (pp. 157–164).

Open Access This chapter is licensed under the terms of the Creative Commons Attribution 4.0 International License (<http://creativecommons.org/licenses/by/4.0/>), which permits use, sharing, adaptation, distribution and reproduction in any medium or format, as long as you give appropriate credit to the original author(s) and the source, provide a link to the Creative Commons license and indicate if changes were made.

The images or other third party material in this chapter are included in the chapter’s Creative Commons license, unless indicated otherwise in a credit line to the material. If material is not included in the chapter’s Creative Commons license and your intended use is not permitted by statutory regulation or exceeds the permitted use, you will need to obtain permission directly from the copyright holder.



Chapter 10

Artefacts and Tasks in the Mathematical Preparation of Teachers of Elementary Arithmetic from a Mathematician's Perspective: A Commentary on Chapter 9



Bernard R. Hodgson 

10.1 Introduction

The main focus of this paper is the mathematical preparation of primary school teachers in relation to the teaching of elementary – whole number – arithmetic. My comments are based mostly on my experience and reflections as a mathematician involved in the education of pre-service teachers, but with occasional inspiration from development activities for in-service teachers with whom I collaborated.

As a consequence, the prime intent of the paper is not to examine what may be happening about the learning of arithmetic by actual pupils in classrooms but rather to concentrate on the kind of ‘adult experiences in mathematics’ that, in my opinion, prospective teachers ought to encounter in order to better prepare for their role as guides accompanying their pupils in the acquisition of concepts and skills related to whole number arithmetic.

The context that induced the department of mathematics at my university to create two mathematics courses specifically for future primary school teachers – one of them being devoted to arithmetic – is briefly described in Hodgson and Lajoie (2015). Suffice it here to recall that this involvement has been ongoing now for more than four decades and that the responsibility of preparing prospective teachers for their mathematical duties is shared, and it goes without saying, with the Faculty of Education, where student teachers take three mathematics education courses (*didactique des mathématiques*, in French). The classroom reality and the pupils’ needs are of course more significantly integrated in this didactical environment. An underlying theme of Hodgson and Lajoie (2015) is to stress the complementary roles played by mathematicians and mathematics educators (*didacticiens*) in this endeavour. It should however be noted, as indicated in the survey by Bednarz (2012, Tables

B.R. Hodgson (✉)
Université Laval, Quebec City, QC, Canada
e-mail: Bernard.Hodgson@mat.ulaval.ca

1 and 2), that the model adopted at my university in that connection is rather unusual in the Canadian context (including in the province of Québec).

In order to provide an insight into the arithmetic course (entitled *Arithmétique pour l'enseignement au préscolaire/primaire*) that we have developed for primary school teachers and crystallise its main intents, I wish in this paper to examine both its spirit and some of its components. This will bring me to consider the two central themes at the heart of Chap. 9 (*Aspects that Affect Whole Number Learning: Cultural Artefacts and Mathematical Tasks*): the importance and variety of artefacts (often of a cultural and historical nature) that can be used to support the learning of whole number arithmetic, as well as the role played by mathematical tasks proposed in order to foster the 'mathematical message' that may be conveyed through the artefacts. I will discuss here concrete examples taken from our arithmetic course, intending by so doing to illustrate a crucial observation strongly emphasised in Chap. 9, namely that artefacts and tasks form an inseparable pair. However, I will first present some general observations about the mathematical preparation of primary school teachers with regard to whole number arithmetic.

10.2 Preparing Mathematically for the Teaching of Arithmetic

One should not [...] delay too late the moment when abstraction shall become the form and the condition of the whole teaching: finding for each pupil and for each study the right moment when it is advisable to move from the intuitive form to the abstract form is the great art of a true educator.¹ (Buisson 1911)

The philosophy underlying our arithmetic course is based on the conviction that in order to adequately fulfil their role as guides and become efficient communicators, primary school teachers should have developed such a level of mathematical competency that they see themselves as being in full possession of the mathematical tool with which they will be working, in other words that they feel *autonomous* with respect to their mathematical judgements concerning primary school arithmetic. We thus offer to the student teachers an opportunity for a personal reconstruction of elementary arithmetic through a mathematical pathway intended to allow them to clarify and develop basic notions underlying the teaching and learning of arithmetic at the primary level. This enterprise can be interpreted as aiming to both demystify and demythicise mathematics in general, but especially arithmetic, for prospective teachers.

¹ Original French text: 'Il ne faut (...) pas reculer trop tard le moment où l'on fera de l'abstraction la forme et la condition de tout l'enseignement: trouver pour chaque élève et pour chaque étude le moment précis où il convient de passer de la forme intuitive à la forme abstraite est le grand art d'un véritable éducateur'.

Hopefully, such an experience will allow them to gain confidence in their own expertise – of a very specific nature – about mathematics as seen in relation to the education of primary school pupils.

Part of what we aim at achieving on the subject of arithmetic with our student teachers is well captured by a quotation from the illustrious mathematician Leonhard Euler, the author, it should be reminded, of many influential textbooks intended for students. In the preface of an arithmetic textbook for Russian schoolchildren published in 1738 under the auspices of the St Petersburg Academy of Sciences, *Einleitung zur Rechenkunst (The Art of Reckoning)*, Euler wrote:

The learning of the art of reckoning without some basic principles is sufficient neither for solving all cases that may occur nor to sharpen the mind, as should be our specific aim. [...] Thus when one not only grasps the rules [of reckoning], but also clearly understands their causes and origins, then one will to some extent be enabled to invent new rules of one's own, and to use these to solve such problems, for which the usual rules would not be sufficient. One should not fear that the learning of arithmetic might thus become more difficult and require more time than when the raw rules are presented without any explanation. Because any individual understands and retains much more easily those matters, whose causes and origins he clearly comprehends.² (Euler 1738, pp. 3–4)

It is far from me to suggest that the aims or means of our arithmetic course are in any way new or revolutionary. For a very long while, a number of authors have been reflecting on the need to improve the mathematical preparation of pre-service school teachers and proposing varied and at times highly innovative approaches. One outstanding example is given by Felix Klein, the very first President of ICMI (1908–1920), who presented in the early twentieth century a famous series of lectures intended for teachers (Klein 1932). Although Klein was then mainly addressing secondary school teachers of mathematics, parts of his comments, especially in the very first chapter devoted to ‘calculating with natural numbers’, can be seen as pertaining directly to elementary arithmetic, and the needed mathematical background and vision with which primary school teachers, in his opinion, should be familiar. Another example, having as a setting my own university but at the time of the ‘New Math’ era, is given by Wittenberg, Sister Sainte Jeanne de France and Lemay (Wittenberg et al. 1963) – the three authors were then all connected to the mathematics department. Resisting the ‘bourbakised’ vision of mathematics teaching (p. 91) then quite fashionable, the authors reflect on the numerous reform movements of those days which, they claim:

²Original German text: ‘Die Erlernung der Rechenkunst ohne einigen Grund weder hinreichend ist, alle vorkommenden Fälle aufzulösen, noch den Verstand schärfet, als dahin die Absicht insonderheit gehen sollte. [...] Dann wann man auf diese Art nicht nur die Regeln begreift, sondern auch den Grund und Ursprung derselben deutlich einsieht, so wird man einigermaßen in Stand gesetzt, selbstnen neue Regeln zu erfinden und vermittelst derselben solche Aufgaben aufzulösen, zu welchen die sonst gewöhnlichen Regeln nicht hinreichend sind. Man hat auch im geringsten nicht zu befürchten, dass die Erlernung der Arithmetik auf diese Art schwerer fallen und mehr Zeit erfordern werde, als wann man nur die blossen Regeln ohne einigen Grund vorträgt. Dann ein jeder Mensch begreift und behält dasjenige im Gedächtnis viel leichter, wovon er den Grund und Ursprung deutlich einsieht’.

at times seem to lock themselves into a surprising and naïve conviction that it is enough, in that domain, to meditate on the thinking of a single man (multiplicatively reincarnated, it is true), and that: *whoever has read Bourbaki, has read everything*.³ (Wittenberg et al., p. 11)

The authors propose a ‘genetic approach’ as a way to allow practising and prospective teachers to see elementary mathematics with new eyes – so to say, to see it as their pupils will – and to reflect on its internal structure (p. 13).

We do not aim, in our arithmetic course for teachers, at presenting a fully fledged ‘genesis’ of the basic concepts related to whole numbers. Still we wish to adhere to a vision that remains as primitive as possible. For that purpose our arithmetical journey relies, to a large extent, on a rudimentary yet very fruitful numerical artefact for tackling numbers: sequences of tallies (Sect. 10.4). This allows us to gradually build a body of knowledge about the (set of) whole numbers, a patent emphasis being put on establishing, with a certain level of rigour, the basic properties at stake. It is thus a structural perspective on elementary arithmetic that we propose to our student teachers, which brings into the discussion a level of abstraction possibly rather new, maybe even strange, to some of them. But as expressed by the renowned French educator Ferdinand Buisson at the turn of the twentieth century (see the quotation as epigraph to this section), such an abstract perspective is at the heart of the teaching and learning process.

Our mathematical approach to ‘arithmetic for teachers’ has clear links to several current or recent research works, such as that of Grossman, Wilson and Shulman (1989), stressing the importance of a teachers’ sound knowledge of mathematical content. It also has connections with the famous study of Ma (1999) concerning a ‘profound understanding of mathematics’, as well as with the work of Ball and Bass (2003) about ‘mathematical knowledge for teaching’. In that context, I think it is of interest to comment, from a mathematician’s perspective, on some of the mathematical artefacts and tasks used in our teaching of arithmetic.

10.3 Accesses to the Concept of Number

‘How do numbers emerge?’ Such is the question raised by Hans Freudenthal, the eighth President of ICMI (1967–1970), at the very outset of a chapter entitled ‘The Number Concept: Objective Accesses’ from his monumental *Mathematics as an Educational Task* (1973, p. 170). He proposes a fourfold distinction, discussing successively – from a mixture of mathematical and didactical vantage points – the emergence of the number concept under the disguises of *counting* number, *numerosity* number, *measuring* number and *reckoning* number.

³Original French text: ‘alors que prolifèrent des entreprises de réforme [qui] semblent parfois s’enfermer dans une surprenante et naïve conviction que c’est assez, dans ce domaine, de méditer la pensée d’un seul homme (multiplicativement réincarné, il est vrai), et que: *qui a lu Bourbaki, a tout lu*’.

(Another way of reacting to the question put forward by Freudenthal is found under the heading ‘The Logical Foundations of Operations with Integers’ of Klein (1932), notably pp. 11–13. While Klein sees issues of psychology and epistemology being at stake, he chooses, as indicated by the title of that section, to propose a mathematical reflection based on a spectrum of perspectives and arguments from logic, including a purely formal theory of numbers.)

Space prevents me here from entering into all the nuances of Freudenthal’s very rich discussion of the various accesses he discusses in relation to the concept of number. But I would like to use his framework as a basis for my reflections and for establishing connections to some of the core ingredients of our arithmetic course for primary school teachers.

10.3.1 *Counting Number*

Freudenthal characterises the notion of counting number as being connected to ‘the reeling off in time of the sequence of natural numbers’ (1973, p. 170). He observes that grasping ‘the whole unlimitedly continuing sequence’ of numbers is for children ‘a conceptual seizure that has no analogue in learning the names of colours and letters’ (1973, pp. 170–171). At stake here is the notion of *successor*, at the heart of the axiomatic approach to arithmetic proposed by Giuseppe Peano, jointly with the principle of mathematical induction. As a consequence of the successor is de facto an order implicitly introduced: we are thus in presence of the general notion of ordinal number.

One possible implementation of the idea of counting numbers is via an artefact that actually plays a fundamental role in our course, sequences of tallies. The idea of successor is then readily perceived as the simple adjunction of a new tally to a given sequence, and this can ‘obviously’ be repeated indefinitely, at least in principle. I shall return to this particular artefact in Sect. 10.4.

One very early encounter of children with counting numbers is when learning a counting list, the successive terms being either written as numerals or expressed as words in their mother tongue. The memorising of the usual oral counting list is often supported by nursery rhymes. A possible task that may be proposed to teachers in that connection is to examine if an actual poem or a song could really be used for counting. What are the qualities that a good ‘counting song’ (or list) should possess? How far could one go with a particular song like *Au clair de la lune* (see https://en.wikipedia.org/wiki/Au_clair_de_la_lune) – for instance, in order to count the number of pupils in the classroom? (Other aspects of songs and poems being used in arithmetic are discussed in Sect. 9.2.2.5.)

One particular task I like to give to my student teachers on the very first day of the course is to build a written counting list using the symbols from some given alphabet. (It is understood here that the alphabet comes with a specific order among the symbols it contains.) Without having yet discussed the notion of positional-value numeration system, I propose to restrict the available digits to, say, 0, 1, 2 and

3 (in that order), and invite them to build a counting list, in the same spirit as our usual list of numerals, but using only these symbols. While some may come back with rather original lists, most of them would have built a list ‘in base four’, analogous to the usual base ten list. But given the alphabet comprising the symbols A, B, C and D, the typical answer

A, B, C, D, AA, AB, AC, AD, BA, BB, ..., DD, AAA, AAB, ...

clearly illustrates that the usual counting list they know very well (base ten) brings into play one symbol having a rather special behaviour: 0.

The learning of the usual oral counting list may introduce some linguistic peculiarities, usually specific to a given language. For instance, an interesting cultural task (in French) is to observe the distinction, when counting by tens, between the ‘regular’

cinquante, soixante, septante, octante, nonante

and the more usual (but depending on countries)

cinquante, soixante, soixante-dix, quatre-vingts, quatre-vingt-dix

the latter being (partly) a remnant of vigesimal numeration (see this volume, Sect. 3.2.2).⁴

10.3.2 Numerosity Number

Using even animals as *cas de figure* for small numerosities, Freudenthal notes that ‘perhaps the numerosity number is genetically earlier than the counting number’ (1973, p. 171). His comments point to the fact that recognising at a glance – without counting – the number corresponding, say, to four dots (even if placed randomly), is an easy task (this capacity, called *subitising*, is described in this volume, Sect. 7.2.1): one can instantly ‘see’ the four dots. But the same is possibly not true for most people when looking quickly at the dots in Fig. 10.1a. However, the pattern used in Fig. 10.1b is such that the numerosity of the dots is immediate. (See also Sect. 9.3.4.2 for comments about strategies related to artefacts with a structural feature such as that of Fig. 10.1b.)

Numerosity rests on the possibility of identifying the ‘number’ corresponding to a certain situation without numbering the objects one by one. The idea is to associate the given situation with another one, the question at stake then being not ‘how many?’ but rather ‘is it as many as?’. While the notion of equipotency (or one-to-one correspondence) on which rests this approach to whole numbers is a very natural one (and it will play a central role when discussing sequences of tallies in Sect. 10.4),

⁴One may be reminded here, for instance, of Molière’s *L’Avare* (1668), when one of Harpagon’s servants, fawning over him about his longevity, says: ‘Par ma foi, je disais cent ans, mais vous passerez les six-vingts’ (Act II, Scene 5).

Fig. 10.1 Numerosity of dots aggregates
 (a): Randomly displayed dots (b): A pattern of dots

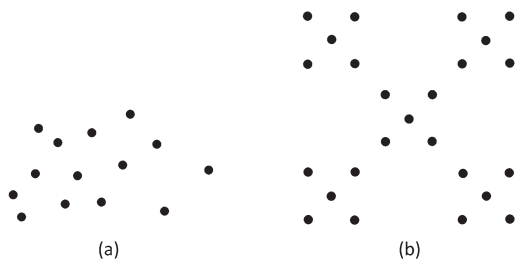

its formalisation via the general notion of cardinal number *à la Cantor* is definitely questionable, according to Freudenthal. (It may be noted here that Klein (1932, p. 12) speaks on the contrary in enthusiastic terms of this ‘modern’ approach due to Cantor.) The criticism made by Freudenthal (1973, p. 181) is as strong as can be:

- (1) The opinion that the numerosity number, that is the potency, suffices as a foundation of natural numbers is mathematically wrong.
- (2) The numerosity aspect of natural numbers is irrelevant if compared with the counting aspect.
- (3) The numerosity aspect is insufficient for the didactics of natural numbers.

Freudenthal then spends more than fifteen pages expounding his objections.

Hodgson and Lajoie (2015, p. 309) mention that the first versions of our arithmetic course, in the 1970s, used a set-theoretic context to introduce natural numbers as cardinalities of finite sets, operations on numbers being defined via set-theoretic operations. This was in accordance with the spirit of the times, as can be seen through a quotation from a report of an ICMI-supported workshop organised by UNESCO in 1971, in a chapter on ‘Primary Mathematics’:

All modern reformed programs have introduced the study of sets into mathematical instruction. This topic is perhaps the most visible trait of an actual change in primary mathematics teaching. [...] There is a universal trend to use sets to develop the concept of cardinal or natural numbers, and the four rational operations on natural numbers. (UNESCO 1973, pp. 5–6)

It was eventually decided to approach whole numbers in our course not on the basis of a possible prior idea of sets, but more intrinsically as ‘primitive’ objects of their own, as well as the operations defined on them: sequences of tallies thus entered the picture.

10.3.3 Measuring Number

Freudenthal discusses the notion of measuring number in a general context, comparison with a given unit leading sometimes to exhaustion of the magnitude to be measured and sometimes to incomplete exhaustion. The latter case can be seen as giving rise either to division with remainder (most appropriately called Euclidean division) or, when the unit is divided, to fractions. Eventually issues of commensurability and incommensurability, in an ancient Greek spirit, may come into play.

Fig. 10.2 The factors of 18, à la Cuisenaire

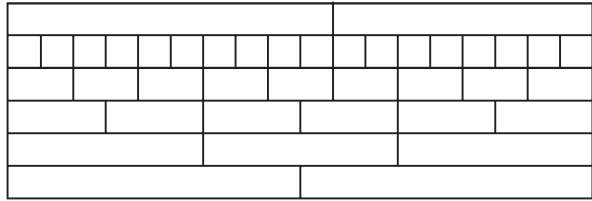

Central notions of elementary theory of numbers (the ἀριθμητική *arithmētikē* of the Greece of Antiquity) can be brought to the fore via the notion of measure: this is precisely how divisibility is introduced in Euclid’s *Elements*. Two most fruitful artefacts to be used here are Cuisenaire rods (this volume, Sects. 8.2.1 and 9.3.1.1) and the number line (Sect. 9.2.2.4).

Although strongly attached, in the collective memory, to the ‘New Math’ era, the Cuisenaire rods have a strong merit of their own, and it may be seen as still pertinent for future teachers to be familiar with this artefact. It is thus a pity that many of our student teachers have never encountered them earlier in their own schooling (as if legions of boxes of Cuisenaire rods were left sleeping in school basements). The simple fact of observing with the rods how a ‘train’ of length, say, 18 (one orange rod and one brown rod), can be divided into series of identical ‘wagons’ in five different ways (eighteen white, nine red, six light green, three dark green, two blue) is without any doubt a most inspiring way of addressing the notion of factors (see Fig. 10.2).

A most relevant distinction can be made here, considering, for instance, the factorisation $18 = 2 \times 9$, between the ‘unit’ 2 being repeated nine times and the ‘unit’ 9 repeated twice.

Transfer, in more generality, to the number line is then immediate. As stressed in Sect. 9.2.2.4, line segments are precisely how Euclid ‘saw’ numbers, including whole numbers. And the issue of a number ‘measuring’ or not another one can readily be addressed via segments on the number line.

I wish to stress here another fertile artefact from ancient Greece for approaching elementary theory of numbers: the use of figurate numbers, that is, of certain geometrical arrangements of collections of dots. This vision of whole numbers does not emphasise an idea of measure, as I just discussed. Going back to the Pythagorean school, it provides a dynamic context revealing rich relations between given family of numbers. For instance, passing from a given square of side n to a square of side $n + 1$ involves the adjunction of a ‘gnomon’ (γνώμων) made of twice the length n and a unit. Fig. 10.3a presents the situation, for the case $n = 4$, in a figurate number style, while Fig. 10.3b uses a more traditional image based on area. It may be pointed out here that the latter artefact has as well a very long history, being present in essentially all the ancient mathematical traditions. Both artefacts of Fig. 10.3 can serve as supports for *visual proofs* – in the present case, of the fact that $(n + 1)^2 = n^2 + (2n + 1)$.

Fig. 10.3 Passing from the square of a whole number to the next

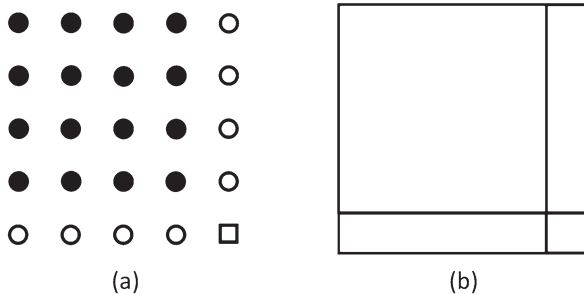

$$\begin{aligned}
 23 \times 15 &= (2 \times 10 + 3) \times (1 \times 10 + 5) & (1) \\
 &= ((2 \times 10 + 3) \times (1 \times 10)) + ((2 \times 10 + 3) \times 5) & (2) \\
 &= ((2 \times 10) \times (1 \times 10) + 3 \times (1 \times 10)) + & (3) \\
 &\quad ((2 \times 10) \times 5 + 3 \times 5) \\
 &= ((2 \times 10) \times 10 + 3 \times 10) + ((2 \times 10) \times 5 + 3 \times 5) & (4) \\
 &= ((2 \times 10) \times 10 + 3 \times 10) + (5 \times (2 \times 10) + 3 \times 5) & (5) \\
 &= (2 \times 10 \times 10 + 3 \times 10) + (5 \times (2 \times 10) + 3 \times 5) & (6) \\
 &= (2 \times 10 \times 10 + 3 \times 10) + ((5 \times 2) \times 10 + 3 \times 5) & (7) \\
 &= (2 \times 10 \times 10 + 3 \times 10) + (10 \times 10 + 15) & (8) \\
 &= (2 \times 10^2 + 3 \times 10) + (10^2 + 15) & (9) \\
 &= (2 \times 10^2 + 3 \times 10) + (1 \times 10^2 + 15) & (10)
 \end{aligned}$$

Fig. 10.4 Fragment of the calculation of 23×15 (detailed style)

10.3.4 Reckoning Number

Freudenthal (1973, p. 171) uses the expression *reckoning number* in order to highlight the algorithmic aspect attached to whole number arithmetic. This is the *logistikē* (λογιστική) of ancient Greece, that is, actual calculations involving operations of elementary arithmetic and, in particular, of course, the ‘four operations’. We are now in the same ballpark as with Euler’s *Rechenkunst* mentioned above.

Reckoning is considered from two different perspectives in our arithmetic course for teachers. One encounter with reckoning happens after about a month of the course, once the basic laws of arithmetic have been introduced and that positional-value numeration (base ten) has been fully reviewed, so that it is then possible to discuss and justify in a thorough manner the functioning of algorithms. A specific task proposed to teachers, concerning standard algorithms, is to identify minutely the way the arithmetic laws enter into action in a given algorithm. For example, concerning the multiplication 23×15 , we provide them with a truly detailed computation (see Fig. 10.4) where the first ten lines from a series of twenty one are reproduced. A single mathematical basic event is enacted on each of these lines, and the students’ task is to identify it.

Of course, we do not ask our students to construct by themselves calculations of such a type, as this is not really a task on which we would want them to devote

energy and time. Nor do we have in mind them later using such a level of scrutiny with their own pupils. But for a teacher, seeing precisely (at least once in one's lifetime) the way the basic arithmetic laws intervene in standard algorithms is, we believe, a most valuable experience.

Another task part of the same discussion is to have our students look for, look at and understand non-standard algorithms for the four operations. We also present them other artefacts of a historical flavour, such as, for multiplication, the gelosia method or Napier's bones (Sect. 9.2.2.3) or the Egyptian algorithm.⁵

The other perspective we introduce in our course concerning reckoning happens on the very first day of the course: we give them as a task (to be done before the next class) to use their knowledge of algorithms for the four operations – these algorithms then play the role of artefacts – so to be able to compute in bases other than ten. We launch the task with them, reminding very briefly the idea of base ten numeration and asking then what if we were using, say, base eight. We make sure that they will go back home on that day having a reasonable intuition of what it means for a numeral to be expressed in a non-usual base such as eight, so that 'all that remains' for them is to do the calculations, using the knowledge they already have of basic arithmetic algorithms. Along the way we make them aware that in order to play the game fully in base eight (and not to 'cheat' via base ten), they will need to have access to information about additions and multiplications of one-digit numbers. An extra implicit task is thus for them to construct by themselves the artefacts for calculations in this new environment, namely, the Pythagorean tables for addition and multiplication in base eight. (See Sect. 9.2.2.3 for comments on Pythagoras tables from the perspective of an artefact.) The next class rests on the work they will have done in the meanwhile.

We eventually tell them explicitly that an aim behind this task is to destabilise them to a certain extent with regard to basic arithmetic skills that may seem, at first sight, trivial. This way a context is created enticing them to get into a deep reflective mode about algorithms that they already know how to perform but are probably not in a position to explain or justify. Many students later testify to this 'non-base-ten calculation' task as a genuine thought-provoking moment for them.

10.4 Defining and Representing Whole Numbers

In passages about basic arithmetic laws in the literature for teachers, one may find comments linking, say, the commutativity of addition to expressions such as

$$345 + 67 = 67 + 345.$$

While this equality may be seen as a fine illustration of the property, the use of such a vision introduces a confusion between many aspects related to numbers, in particular between the nature or essence of natural numbers (or of the operations

⁵https://en.wikipedia.org/wiki/Ancient_Egyptian_multiplication

defined on them) and the representation of these numbers via a numeration system – however important the latter may be in practice.

It is for us of crucial importance in our course for teachers to introduce the natural numbers ‘in themselves’, without any reference to a system for representing them. In the early days of the course, they were introduced as cardinalities of (finite) sets. A major shift occurred in our approach to basic arithmetic when it was decided to restrict sets to a role of ‘linguistic’ tools for communication, instead of primitive concepts on which the whole arithmetical building should be based (see Sect. 10.3.2 above) and to use the (historically primitive) notion of a *tally* (see this volume, Sect. 9.2.2.1) to introduce whole numbers.

10.4.1 Tallies: A Fruitful Artefact for Whole Numbers

All writing may be put down, and nothing used but the score and the tally. Shakespeare (1594), *Henry the Sixth*, Part 2, Act IV, Scene vii (OED 2016)

Natural numbers, it was mentioned earlier, can be captured in a robust way by thinking of them as *counting* numbers (see Freudenthal’s comments in Sect. 10.3). In a written form, this vision can be rendered concretely through a basic artefact, the notion of *tally*,⁶ as well as *sequences of tallies*.

A natural number is ‘naturally’ defined as a sequence of tallies – a *finite* sequence, of course. Accepting such a sequence to be eventually empty is not a major issue (especially with adults) and allows the introduction of 0, of fundamental importance when addition enters into the picture. The set of natural numbers is thus constituted of all the finite sequences of tallies, and this can be accepted as a working definition with prospective teachers.

Leaving aside for the moment the empty sequence of tallies (a special symbol, such as an inverted triangle, could be introduced for that purpose), the (unlimited) sequence of counting numbers thus begins



This artefact explicitly allows the notion of successor to be fully seen in action.

In order to gain a necessary level of generality, a notation such as



may be introduced in order to represent a sequence of tallies of arbitrary length, *n*.

⁶Other words traditionally used in a same sense include *notch*, *score* or *stroke*. A tally is to be considered simply as a mark, typically a short line segment. In our course, we speak of the ‘*bâton*’ (in French), i.e. the *stick*.

Once we have such concrete models for natural numbers, a fundamental notion to discuss is the equality of two given natural numbers, which is to be captured through the verification that the corresponding sequences of tallies are identical. The natural way to render this idea is via the establishment of a bijective link between the two sequences. In the present context, this scheme of one-to-one correspondence between sequences of tallies appears as a most natural artefact, requiring no sophisticated set-theoretic support. It also leads to the definition of order among natural numbers, when one sequence happens to be exhausted before the other in a search for a one-to-one correspondence.

Such a setting in turn allows for operations on natural numbers to be introduced through operations on sequences of tallies which, in that context, can be accepted as natural and primitive. For instance, the addition of two given numbers n and m is defined as the juxtaposition of the corresponding sequences of tallies:

$$\overline{\text{||}\cdots\text{||}}^{n+m} = \overline{\text{||}\cdots\text{||}}^n \overline{\text{||}\cdots\text{||}}^m$$

(with equality here being per definition). The sum $n + m$ is readily seen to be a natural number. In a similar vein, the multiplication of n and m can be defined as the result of replacing each tally in the sequence for n by a replica of the sequence for m . For matters of convenience, the natural number $n \times m$ obtained as the product sequence can be displayed as a rectangular array (or matrix) of tallies:

$$n \left| \begin{array}{c} \overline{\text{||}\cdots\text{||}}^m \\ \text{||}\cdots\text{||} \\ \text{||}\cdots\text{||} \\ \vdots \\ \text{||}\cdots\text{||} \end{array} \right.$$

From these definitions (using the notion of the empty sequence of tallies) follow immediately, for instance, two basic arithmetical facts: when a sum $n + m$ is 0, then both terms are 0; and when a product $n \times m$ is 0, then at least one of the factors is 0.

It may be noted that a similar artefact for counting numbers is the model of boxes of aligned dots used by Courant and Robbins (1947, p. 2 et seq.) in their study of the laws governing the arithmetic of whole numbers. Addition then corresponds to ‘placing the corresponding boxes end to end and removing the partition’ (p. 3):

$$\boxed{\bullet \bullet \bullet \bullet \bullet} + \boxed{\bullet \bullet \bullet} = \boxed{\bullet \bullet \bullet \bullet \bullet \bullet \bullet \bullet}$$

while the multiplication $n \times m$ is defined via a box with n rows and m columns of dots (eventually reorganised as a box of aligned dots).

10.4.2 *Establishing the Basic Laws of Arithmetic*

The tally artefact has as a bonus the feature that the basic properties of arithmetic can be actually *proved* and not merely stated or illustrated. For instance, the property of commutativity of addition, mentioned at the beginning of this section, then amounts to the following: given two arbitrary sequences of n and m tallies, one shows that the order of juxtaposition does not matter by an appeal to the obvious one-to-one correspondence – the rightmost tally of m in the sequence $n + m$ is linked to the leftmost tally of m in $m + n$ and so forth. Both sequences $n + m$ and $m + n$ will then be exhausted simultaneously.

In turn all other fundamental properties of addition and multiplication can be proved similarly, thus leading to the establishment of ‘the fundamental laws of reckoning’ (associativity and commutativity of $+$ and \times , identity elements, compatibility of $=$ with $+$ and \times , simplification for $+$ and \times , distributivity $\times/+$, laws concerning order) (see, e.g. Klein (1932), p. 8, where such rules are simply stated). It is important, with teachers, to stress that these properties speak of the behaviour per se of numbers and certain operations defined on them and, as such, are totally independent of numeration, i.e. of ways of ‘writing down’ the numbers in a given system.

It may be noted that the artefact of tallies, as a concrete model for whole numbers, comes with practical limitations: for instance, given two sequences made, respectively, of, say, one thousand and one thousand and one tallies, it would be quite cumbersome to compare their size by searching for a possible one-to-one correspondence. But such is not the main point behind this artefact: the really crucial aspect is that we have a precise agreement about what any given natural number ‘is’. Such a vision, independent of any numeration system, is a fundamental awareness for a teacher.

The interested reader will have noticed that we are now very close to the principle of mathematical induction and the full set of Peano axioms. While mentioning this en passant, we do not see it as appropriate to insist on such an abstract vision in our course for primary school teachers.

10.4.3 *Representing Whole Numbers*

Of course, the time comes, in our arithmetic course for teachers, when the concept of number emerging from the preceding tally-wise definition should be related to standard arithmetic practice, and in particular to our usual positional-value numeration system in base ten. The many devices and variants for representing numbers developed throughout history turn out to be very informative artefacts in order to distinguish between two fundamental issues at stake when writing or recording numbers: establishing a numeration scheme for memory or communication purposes, and establishing one for reckoning purposes.

Fig. 10.5 The ‘cargo method’ of F. Lemay

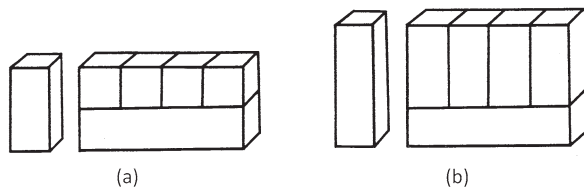

Many interesting artefacts are available, often of a strongly cultural nature, as regards memory or communication devices for numbers: tallies, Egyptian numeration, Roman numeration, quipus, etc. When emphasis is put on devices facilitating calculations, a different set of artefacts may come to mind – in particular abaci – where the notion of position is part of the artefact itself. (See Sect. 9.2.2 for a rich catalogue of artefacts for whole number arithmetic used throughout history.)

The power of the positional nature of our usual numeration system should not be underestimated when it comes to consider it from a reckoning perspective.⁷ Devices emphasising position thus play a crucial role in that connection. Many such artefacts are discussed in Chap. 9, in particular in Sects. 9.3.1.2 (multibase arithmetic blocks) and 9.3.1.3 (spike abaci). In the case of the blocks, the position is transmitted via the size of blocks, while for the abaci it is the place of a given spike on the physical device that indicates position.

Mention is made in Sect. 9.3.1.3 of the possibility of using beads of different colours being piled on the various spikes of an abacus in order to make more evident the difference in the roles played by the beads. The authors then observe that such a use of colours ‘seems not advisable, as attention is focused on colours and exchange conventions rather than on order and position’.

While agreeing fully with the importance of stressing order and position when learning about positional value, I would suggest that an artefact integrating colours, and even emphasising exchanges through a colour code, may be of interest on its own, at least when working with teachers.

I wish to briefly describe here an artefact, due to Lemay (1975), based on the Cuisenaire rods and using both the lengths and the colours of the rods in order to develop the core for a positional-value system. The so-called ‘cargo method’ of Lemay (*méthode des cargaisons*, in French) leads to a mechanical way for exchanging, without counting, a certain sets of rods for a rod of the ‘next type’.

We first agree on a certain rod serving as a basis for numeration – the word basis being taken here as well in a truly physical sense. In the example of Fig. 10.5, we use the pink rod (of length four) as the basis, lain horizontally. The exchange process rests on the following rule: if a number of rods of the same colour can be placed upright side by side so as to cover it completely, it can be exchanged for a rod whose length matches the total height of the freight (still standing vertically on the basis).

⁷One may be reminded here of a famous engraving from Gregor Reisch’s *Margarita philosophica* (1503), where an allegorical figure of Arithmetic appears to express her preference in a kind of calculation contest between the ‘Ancient’ and the ‘Modern’ (see Swetz and Katz 2011).

Figure 10.5a shows a cargo of white rods being exchanged for one red rod, and Fig. 10.5b, a cargo of red rods replaced by a light green one.

This method clearly leads to a fully fledged positional-value numeration system (base four in the example), the length of the successive rods corresponding to the position of digits in a given numeral.

Such an artefact could be related to one involving strictly a colour code, the Cuisenaire rods being simply replaced by colour tokens. The exchange rule then requires grouping the tokens of a given colour (e.g., by counting) so as to form a heap to be exchanged for one token of the next colour. Although possibly considered more abstract, as no physical indication for the ‘weight’ of a digit (i.e. its position) is conveyed by the colour itself, such a system appears of unquestionable importance. It corresponds, for instance, to two important historical artefacts, the (additive) Egyptian and Roman numeration systems. The fact, in the latter case, that the symbol L, say, corresponds to fifty has no (immediate) physical connection – although the history of the Roman characters may be of interest on its own, as plainly shown by Ifrah (2000, pp. 187–200).

It is thus of importance to convey the idea that the value of a given element may depend strictly on the agreement made about it and not on its physical size. While clearly of fundamental interest for positional numeration, multibase arithmetic blocks, for that matter, do not convey the whole story of numeration. Non-physical (or abstract, if one wishes) exchange codes are also present in concrete artefacts (and daily situations), such as monetary systems. Among the Canadian coins, for instance, the 10¢ coin is smaller than the 5¢ coin, but children have no problem agreeing to this arbitrary value. (The fact that the ‘unit’, namely, the 1¢ coin, has recently disappeared from physical monetary transactions in Canada raises other interesting numerational issues, as the 5¢ does not really correspond to a heap of five 1¢ but rather takes its value from an abstract agreement.)

10.4.4 Historical, Logical and Didactical Background to the Tallies

Hodgson and Lajoie (2015) offer comments on the long and diverse history of the use of tallies as an artefact for counting numbers, from ‘early stone age’ to more recent centuries. Using passages from Ifrah (2000), they recall how present this approach to numbers is among many cultures.

Sequences of tallies can also be seen as a practical artefact of ancient times, but one still largely in use even today when counting a not-too-large population, often implemented by means of groupings by five:

| || ||| |||| + + + + + + | ...

In a modern context, this ‘unary’ vision of natural numbers is often encountered in works pertaining to logic, be it in an epistemological context, as ‘a primitive form of notation for natural numbers’ (Steen 1972, p. 4), or in relation to the notion of computability as defined via Turing machines (Kleene 1952, p. 359) (Davis 1958, p. 9). It may be of interest to note in the latter case that in order to have access to a simple notation for 0, a sequence of $n + 1$ tallies is used to represent the natural number n as a ‘tape expression’ on the Turing machine. Steen emphasises the generative aspect of sequences of tallies, starting with the sequence made of a single tally and accepting as a construction rule the adjunction of a tally to a given sequence (see also Lorenzen (1955, p. 121 et seq.), under a chapter entitled ‘Concrete mathematics’⁸).

As an example of a recent didactical application, this ‘*constructive* (or operative) *foundation* of natural number’ presented by Lorenzen, and in particular the ‘calculus of counting actions’ just described, is acknowledged by Wittmann (1975, p. 60) as the basis of the reflections he proposes about the teaching and learning of natural numbers.

10.5 A Miscellany of Artefacts and Tasks for Elementary Arithmetic

I now mention briefly a few other artefacts and tasks pertinent to elementary arithmetic and used in our course.

10.5.1 *An Artefact for Focusing on Remainders: Clock Arithmetic*

Today is Tuesday. What day of the week will it be in 18 days from today? Or: It is now 15:30. What time will it be in 1000 hours from now? Such questions, connected to daily basic arithmetic, emphasise the fact that in many contexts related to division, the remainder may be seen as more relevant than the quotient. Being familiar with the 12-hour (and the 24-hour) clock is an important basic learning. And this in turn may be the starting point supporting the main ideas of modular arithmetic in general, using as an artefact so-called clock arithmetic.

⁸It may be noted that another artefact for natural numbers found in logic, of a more advanced nature, is provided by the so-called von Neumann ordinals (von Neumann 1923). They amount to have each ordinal be defined as the set of ordinals that precede it (the empty set being taken as the starting point, ordinal 0). In such a context, we have, for instance, $3 = \{0,1,2\}$, that is, 3 is a specific set with three elements. A nice feature of this definition of ordinal numbers is that it allows easily the transfer to transfinite ordinals. But we are then a bit beyond primary school arithmetic.

Fig. 10.6 The 7-hour clock

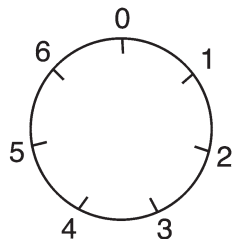

Fig. 10.7 The six-column Eratosthenes sieve (for primes up to 50)

2	3	4	5	6	7
8	9	10	11	12	13
14	15	16	17	18	19
20	21	22	23	24	25
26	27	28	29	30	31
32	33	34	35	36	37
38	39	40	41	42	43
44	45	46	47	48	49

Figure 10.6 shows a slightly special clock, namely, a ‘7-hour’ clock (with 0 used instead of 7, in distinction from a standard clock). It is easy to define basic arithmetical ‘clock operations’ in this environment, such as addition: $2 + 18 = 6$ (which may be read as today being Tuesday, it will be Saturday in 18 days). Subtraction and multiplication are as well easily implemented: we are thus in the vicinity of the ring $\mathbb{Z}/n\mathbb{Z}$.

10.5.2 An Artefact for Finding Prime Numbers: The Six-Column Sieve

The sieve of Eratosthenes is a well-known device for finding prime numbers. Experience shows that students will very frequently list the natural numbers in ten columns in order to do the sieving. However, using as an artefact a six-column sieve (Fig. 10.7) immediately reveals a nice phenomenon, once the proper multiples of the first two primes have been eliminated: *with the exception of 2 and 3, all prime numbers are of the form $6k + 1$ or $6k - 1$* . This is a fine example of a visual proof: the artefact in itself ‘is’ the proof of this result. The sieving process is then made considerably easier due to the format of the sieve. See Hodgson (2004, pp. 334–335) for further details.

A crucial related task here is of course to ask: why six columns? A bit of elementary theory of numbers – either using 6-hour clock arithmetic or examining a prime p jointly with its two neighbours, $p - 1$ and $p + 1$ – will be helpful in bringing out the fact that ‘we knew’ already that any prime, besides 2 and 3, is the neighbour of a multiple of 6. However, the artefact in itself is still of interest in primary education.

10.5.3 An Artefact for Observing Divisors: A Brick in the Wall

I have mentioned above (see Sect. 10.3.3) how Cuisenaire rods may be used for showing in action, so to say, the divisors of a given number. The same artefact may be used for finding concretely common divisors of two numbers, and this way ‘see’ the GCD. A similar remark applies to common multiples and LCM of numbers.

10.5.4 An Artefact for Applying Divisors: The Long Hotel

A well-known problem in the literature for primary school teachers is the ‘Long Hotel’ problem, using the parlance of Cassidy and Hodgson (1982). The underlying artefact is set as follows: there are n rooms along a long corridor, and the n guests consecutively apply an ‘open/close’ process on the doors, Guest $\#k$ changing the position of every k -th door (starting with door $\#k$). The question of determining which doors are left open and which ones are closed at the end of the process boils down to identifying the divisors of a given door number, and more precisely the parity of the number of divisors: the perfect squares here stand out as of special interest.

10.5.5 An Artefact for Applying GCD and LCM: The Circle Hotel

Cassidy and Hodgson (1982) introduce a variant to the preceding problem, using the ‘what-if-not’ strategy in problem posing and transferring the process to a circular corridor. The ‘Circle Hotel’ problem provides a nice context to see clock arithmetic in action. It turns out in this case that a single door remains open at the end of the process, the precise nature of the door number depending on the parity of n .

Various additional questions can be asked in this context, related, for instance, to the number of times Guest $\#k$ will go round the corridor before stopping (i.e. before touching the same doors again) or the number of doors Guest $\#k$ will have touched during the process. The answers to these questions have to do with the GCD and the LCM of n and k and are connected to a famous artefact from a few decades ago, the so-called Spirograph. Figure 10.8a shows the figure generated with the Spirograph by rolling a small wheel of 30 teeth inside a big wheel of 105 teeth, which corresponds to the action of Guest $\#30$, when the Circle Hotel has 105 rooms.

Considered as an artefact, the Spirograph is of special interest on its own, as the elegance and beauty of the figures it can generate may play the role of ‘attention-catcher’ and invite to indulge in further investigation, for instance, about the family of star polygons $\{n/d\}$ (Fig. 10.8b). These are (generalised) polygons obtained by connecting with line segments every d -th point on a circle where n equally spaced points are marked. Such aspects are discussed in Hodgson (2004, pp. 324–328).

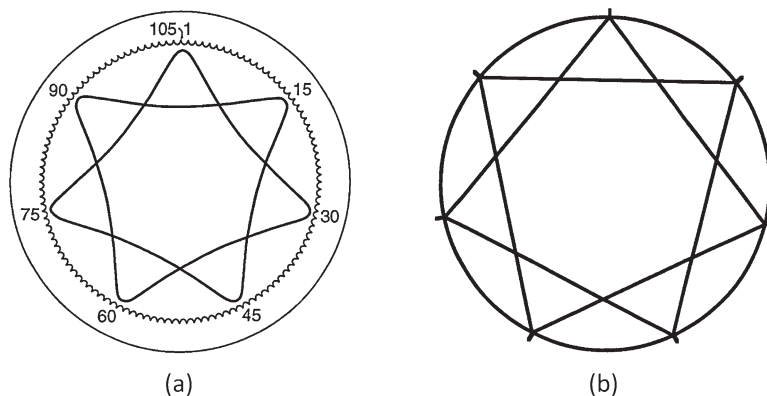

Fig. 10.8 The Spirograph curve 105/30 and the star polygon $\{7/2\}$

10.5.6 An Algorithmic Artefact: The Euclidean Algorithm

Understanding and applying the Euclidean algorithm for finding the GCD of two numbers can be seen as a task appropriate for prospective primary school teachers. It has a very positive impact, as this algorithm is totally new to most student teachers. This algorithm provides the occasion for a nice learning experience, as prospective teachers are then in the same situation as their future pupils with respect to encountering a certain algorithm for the first time.

This algorithm, via Bézout's identity, then becomes a fine artefact for solving 'popular' problems, such as whether it is possible or not to obtain a certain quantity of water using two pails whose capacity is known.

10.5.7 Visual Artefacts: Proofs Without Words

The use of a figure for supporting the proof of – or even for 'proving' by itself – a given arithmetic identity has a long history. Already in Euclid's *Elements*, for instance, are results with a substantial visual component (but such was not of course the spirit of Euclid's approach). A classical example is about the area of the square of side $a + b$ (proposition II.4, accompanied by a figure similar to Fig. 10.3b above). Another result of Euclid (proposition II.1) concerns the area of a large rectangle that has been divided into smaller rectangles (Fig. 10.9a). In modern terms, the situation can be interpreted as corresponding to the distributivity of multiplication over addition.

In a similar spirit, Klein (1932, p. 26) proposes Fig. 10.9b as a support for the formula:

$$(a - b)(c - d) = ac - ad - bc + bd.$$

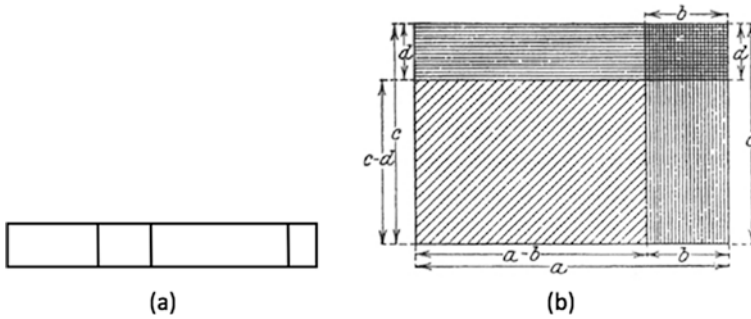

Fig. 10.9 Visual proofs of basic rules of arithmetic

As an additional example, the reader may wish to consider how a ‘loaf’ of balls packed in the shape of a rectangular prism of edges a , b and c may be seen as proving the associativity of multiplication: $a(bc) = (ab)c$. (Hint: One can imagine slices being cut vertically on the one hand and horizontally on the other.)

10.5.8 Tasks Supporting Positional Numeration

I end this brief survey of additional artefacts and tasks by considering a few tasks intended to foster the understanding of positional-value numeration systems (in particular ones in base ten).

10.5.8.1 Trading Bases

A natural question, when considering a numeration system in a base other than ten, is to consider how to transfer a given (base ten) numeral to the new base, and vice versa. Eventually such a question could be addressed considering arbitrary bases a and b , going directly from one system to the other without transiting via base ten. Necessary artefacts would then be the Pythagorean tables for the bases at stake. Experience shows that if student teachers are left on their own facing such a task, the following three methods will eventually appear:

- Dividing the given number by the grouping order of the target base (computations then take place in the source base).
- ‘Exhausting’ the number by multiples of powers of the target base (computations also take place in the source base).
- Evaluating the number in the target base (computations now take place in the target base).

Understanding the principles behind each of these methods sheds light on important aspects of numeration.

10.5.8.2 Paginating a Book

Here are problem-solving tasks providing nice insights into numeration:

- How many digits (i.e. printed characters) will one use in order to paginate a book of, say, 789 pages?
- Reciprocally, if so many characters have been used to paginate a book, how many pages does it have?
- In a similar spirit, how many times does one use the digit 7 when writing down all the numbers from 1 to 99,999?

10.5.8.3 Factorials and Fractions

Two problems emphasising the role played by the prime factors of the base are:

- By how many 0s does $77!$ end?
- Moving to rational numbers, one may ask when does a fraction a/b (given in its lowest terms) correspond to a terminating decimal expansion?

10.5.8.4 Casting Out Nines

A nice artefact with a long history is the ‘casting out nines’ procedure for testing the validity of a given reckoning, for instance, the computation of a product. Examining the functioning of this algorithm on the basis of clock arithmetic provides a rich context for entering into the functioning of our numeration system. A nice aspect that can be raised about this test is the issue of ‘false positives’. And what about ‘casting out threes’ or ‘casting out elevens’?

More generally, understanding divisibility criteria is a task fostering the understanding of positional numeration.

10.6 Conclusion

A central aim of the arithmetic course we propose to prospective primary school teachers is to help them develop a solid ‘conceptual understanding’ allowing to perceive mathematics not as a mere bunch of facts to be memorised, but rather as a coordinated system of ideas. We hope this way to contribute to the growth of their autonomy and critical analysis skills.

This paper has concentrated on the competency of teachers in mathematics (and especially in basic arithmetic), a crucial aspect of their preparation – but, it goes without saying, not the whole story (see Sect. 9.3.4.2). The interested reader will find in Hodgson and Lajoie (2015) brief comments about how the approach to whole number arithmetic described here can serve as a basis for other numerical

contexts (Z and Q), as well as a discussion on how the didactical component of the preparation of primary school teachers can make use of artefacts such as sequences of tallies.

A crucial point raised at different places in Chap. 9 is the fact that artefacts and tasks are intimately linked together. While ‘artefacts have the potential to foster students’ construction of mathematical concepts in whole number arithmetic’ (beginning of Sect. 9.4), they do not exist by themselves, pedagogically speaking. They must be related to some mathematical tasks. And reciprocally, as shown repeatedly in this paper, a given mathematical task is typically based on a certain artefact, be it a physical tool, an algorithm, or a device such as a sequence of tallies, coming both with a facet of concrete implementation and one of abstract conceptual object.

In spite of a comment made in the introduction, namely, that the learning of arithmetic by actual pupils is not an immediate aim of the work we do with our student teachers, I would maintain that many of the artefacts and tasks discussed in our arithmetic course (and in this chapter) can be transferred to pupils, but of course with a necessary adaptation, as our target audience comprises adults with already a substantial, even if at times frail, mathematical background and not young children new to such notions.

Acknowledgements I wish to thank Caroline Lajoie and Frédéric Gourdeau for their most inspiring discussions about the topic of this paper. I also wish to express my gratitude to Linda Lessard, sessional lecturer at Université Laval, with whom I have closely collaborated over a period of more than 35 years in the teaching of arithmetic and geometry to prospective primary school teachers.

This paper is dedicated to the memory of William S. Hatcher (1935–2005), my mentor in the field of mathematical logic and former colleague, who influenced in a significant way the basic vision of arithmetic developed in our courses supporting primary education.

References

- Ball, D. L., & Bass, H. (2003). Toward a practice-based theory of mathematical knowledge for teaching. In E. Simmt & B. Davis (Eds.), *Proceedings of the 2002 annual meeting of the Canadian Mathematics Education Study Group/Groupe canadien d'étude en didactique des mathématiques* (pp. 3–14). Edmonton AB: CMESG/GCEDM.
- Bednarz, N. (2012). Formation mathématique des enseignants: état des lieux, questions et perspectives. In J. Proulx, C. Corriveau, & H. Squalli (Eds.), *Formation mathématique pour l'enseignement des mathématiques: pratiques, orientations et recherches [Mathematical preparation for the teaching of mathematics: Practices, orientations and researches]* (pp. 13–54). Québec: Presses de l'Université du Québec.
- Buisson, F. (1911). *Nouveau dictionnaire de pédagogie et d'instruction primaire*. Entrée: Abstraction [*New dictionary of pedagogy and primary education*. Headword: Abstraction]. Paris: Hachette. Retrieved from www.inrp.fr/edition-electronique/lodel/dictionnaire-ferdinand-buisson/document.php?id=1971
- Cassidy, C., & Hodgson, B. R. (1982). Because a door has to be open or closed... *Mathematics Teacher*, 75(2), 155–158. (Reprinted in S.I. Brown & M.I. Walter (Eds.), *Problem posing: Reflections and applications* (pp. 222–228). Hillsdale: Lawrence Erlbaum, 1993.)

- Courant, R., & Robbins, H. (1947). *What is mathematics? An elementary approach to ideas and methods*. New York: Oxford University Press.
- Davis, M. (1958). *Computability and unsolvability*. New York: McGraw-Hill Book Company.
- Euler, L. (1738). *Einleitung zur Rechen-Kunst zum Gebrauch des Gymnasii bey der Kayserlichen Academie der Wissenschaften in St. Petersburg*. [The Art of Reckoning.] St. Petersburg, Russia: Academischen Buchdruckerey. Reprinted in Euler's *Opera Omnia*, ser. III. vol. 2 (pp. 1–303). Leipzig, Germany: B.G. Teubner, 1942. Retrieved from www.math.uni-bielefeld.de/~sieben/euler/rechenkunst.html
- Freudenthal, H. (1973). *Mathematics as an educational task*. Dordrecht: D. Reidel Publishing Company.
- Grossman, P. L., Wilson, S. M., & Shulman, L. S. (1989). Teachers of substance: Subject matter knowledge for teaching. In M. C. Reynolds (Ed.), *Knowledge base for the beginning teacher* (pp. 23–36). Toronto: Pergamon Press.
- Hodgson, B. R. (2004). The mathematical education of school teachers: A baker's dozen of fertile problems. In J. P. Wang & B. Y. Xu (Eds.), *Trends and challenges in mathematics education* (pp. 315–341). Shanghai: East China Normal University Press.
- Ifrah, G. (2000). *The universal history of numbers: From prehistory to the invention of the computer*. New York: Wiley.
- Kleene, S. C. (1952). *Introduction to metamathematics*. Amsterdam: North-Holland Publishing Co.
- Klein, F. (1932). *Elementary mathematics from an advanced standpoint: Arithmetic, algebra, analysis*. New York: Macmillan. [Translation of volume 1 of the three-volume third edition of *Elementarmathematik vom höheren Standpunkte aus*. Berlin, Germany: J. Springer, 1924–1928.]
- Lemay, F. (1975). L'expression numérique du plural (méthode des orbites). [The numerical expression of the plural (the method of orbits).] Laboratoire de didactique, Faculté des sciences de l'éducation (Monographie no. 8). Québec: Université Laval.
- Lorenzen, P. (1955). *Einführung in die operative Logik und Mathematik*. Berlin: Springer.
- Ma, L. (1999). *Knowing and teaching elementary mathematics: Teachers' understanding of fundamental mathematics in China and the United States*. Mahwah: Lawrence Erlbaum Associates.
- OED (2016). *Oxford English Dictionary* (online version). Headword: Score—II ('Notch cut for record, tally, reckoning'), 9.a.
- Steen, S. W. P. (1972). *Mathematical logic with special reference to the natural numbers*. Cambridge: Cambridge University Press.
- Swetz, F. J., & Katz, V. J. (2011). *Mathematical treasures—Margarita philosophica of Gregor Reisch*. Convergence. Retrieved from www.maa.org/press/periodicals/convergence/mathematical-treasures-margarita-philosophica-of-gregor-reisch
- UNESCO. (1973). *New trends in mathematics teaching* (Vol. III). Paris: UNESCO.
- von Neumann, J. (1923). Zur Einführung der transfiniten Zahlen. *Acta scientiarum mathematicarum*, 1, 199–208. English translation in J. van Heijenoort (Ed.) *From Frege to Gödel: A source book in mathematical logic, 1879–1931* (pp. 346–354). Cambridge, MA: Harvard University Press.
- Wittenberg, A., Soeur Sainte-Jeanne-de-France & Lemay, F. (1963). *Redécouvrir les mathématiques: exemples d'enseignement génétique*. [Rediscovering mathematics: Examples of genetic teaching.] Neuchâtel: Éditions Delachaux & Niestlé.
- Wittmann, E. (1975). Natural numbers and groupings. *Educational Studies in Mathematics*, 6(1), 53–75.

Cited papers from Sun, X., Kaur, B., & Novotna, J. (Eds.). (2015). Conference proceedings of the ICMI study 23: Primary mathematics study on whole numbers. Retrieved February 10, 2016, from www.umac.mo/fed/ICMI23/doc/Proceedings_ICMI_STUDY_23_final.pdf

Hodgson, B. R., & Lajoie, C. (2015). The preparation of teachers in arithmetic: A mathematical and didactical approach (pp. 307–314).

Open Access This chapter is licensed under the terms of the Creative Commons Attribution 4.0 International License (<http://creativecommons.org/licenses/by/4.0/>), which permits use, sharing, adaptation, distribution and reproduction in any medium or format, as long as you give appropriate credit to the original author(s) and the source, provide a link to the Creative Commons license and indicate if changes were made.

The images or other third party material in this chapter are included in the chapter's Creative Commons license, unless indicated otherwise in a credit line to the material. If material is not included in the chapter's Creative Commons license and your intended use is not permitted by statutory regulation or exceeds the permitted use, you will need to obtain permission directly from the copyright holder.



Chapter 11

How to Teach and Assess Whole Number Arithmetic: Some International Perspectives



Jarmila Novotná , Berinderjeet Kaur 
Ann Gervasoni , Mike Askew , Michiel Veldhuis , Catherine Pearn ,
and Xu Hua Sun 

11.1 Introduction

11.1.1 About the Chapter

In accordance with the programme components at the ICMI Study 23 Conference in Macao (Theme 4), this chapter focuses on the diverse theoretical and methodological frameworks that capture the complex relationship between whole number learning, teaching and assessment. Its aim is to bring these diverse perspectives into conversation.

The importance of the theme for students' development of understanding mathematics, and their overall learning, is obvious. This is highlighted in the Discussion

Electronic Supplementary Material The online version of this chapter (doi:[10.1007/978-3-319-63555-2_11](https://doi.org/10.1007/978-3-319-63555-2_11)) contains supplementary material.

The first two authors wrote the chapter with the collaboration of other working group members.

The first author was supported by the project PRVOUK P15 *The school and teaching profession in the context of growing educational demands*.

The last author was supported by Research Committee, University of Macau, Macao, China (MYRG2015-00203-FED). The opinions expressed are those of the author.

J. Novotná (✉)

Charles University, Prague, Czech Republic, and Laboratoire “Culture et Diffusion des Savoirs”, Université de Bordeaux, Bordeaux, France
e-mail: jarmila.novotna@pedf.cuni.cz

B. Kaur (✉)

National Institute of Education, Nanyang Technological University, Singapore, Singapore
e-mail: berinderjeet.kaur@nie.edu.sg

A. Gervasoni

Monash University, Melbourne, Victoria, Australia

© The Author(s) 2018

M.G. Bartolini Bussi, X.H. Sun (eds.), *Building the Foundation: Whole Numbers in the Primary Grades*, New ICMI Study Series,
https://doi.org/10.1007/978-3-319-63555-2_11

251

Document (this volume, [Appendix 2](#)) as well as in other chapters of the book. There are many approaches to WNA teaching and assessment throughout the world and within countries. Describing all approaches cannot be presented in one chapter of the book. Instead, the authors present one concrete example of school practice – the lesson observed by ICMI23 participants at a primary school in Macao – and use the lesson as a stimulus for discussing ideas about teaching, learning and assessing WNA.

The chapter is divided into seven sections (including this introductory text with the overview of the Theme 4 programme). The focus for all sections is how teachers promote the development of students' metacognitive strategies during their learning of WNA. Each section develops an important aspect of the theme. A description of the Macao Primary School lesson is first presented (Sect. 11.2). This provides the context for the subsequent sections, except for the one focusing on textbooks (as during the lesson textbooks were not explicitly used). The two versions of the variation theory (Sect. 11.4) and the theory of didactical situations (Sect. 11.5) are used as lenses to interpret the lesson. How teachers' knowledge is related to their teaching approaches is discussed in Sect. 11.3, while Sects. 11.6 and 11.7 focus, respectively, on assessment and textbooks which are significant domains for the teaching and learning of WNA.

The topics discussed in this chapter each have important implications for teacher education. These are discussed in Chap. 16. Furthermore, there were several questions from the Discussion Document (this volume, [Appendix 2](#)) discussed during the working group 4 sessions and published in the conference proceedings. In order to show the richness of discussions among the working group 4 participants, the descriptions of all contributions to the topic are summarised in Sect. 11.1.2. Readers interested in more detailed information about any discussed aspect can find the corresponding papers in the ICMI Study 23 Proceedings.

11.1.2 What Was Presented at the Conference: Overview

Theme 4 addressed general and specific approaches to teaching and assessing WNA. In the thematic group, theoretical and methodological frameworks that could capture the complex relationship between whole number learning, teaching and

M. Askew

University of the Witwatersrand, Johannesburg, South Africa, and Monash University, Melbourne, Victoria, Australia

M. Veldhuis

Utrecht University, Utrecht, The Netherlands

C. Pearn

The University of Melbourne, Melbourne, Victoria, Australia

X.H. Sun

Faculty of Education, University of Macau, Macao, China

assessment were considered. The background question for all contributions to Theme 4 was the same as for this chapter: how can teachers promote the development of students' metacognitive strategies during the learning of WNA?

Fourteen papers written by authors from 13 countries were accepted for this theme. They addressed the issues of teaching and assessing WNA from different perspectives. The contributions by participants from many countries offered a unique opportunity to compare and contrast different approaches to teaching and assessing WNA.

For presentation and discussion, the papers accepted for Theme 4 were divided into five subgroups according to their main focus. The summary that follows uses these subgroups as an organisational structure. We are aware that it is not possible to make disjoint groups of papers when attending to their main focus. Note: there is no ranking in the order of topics.

11.1.2.1 Teaching Approaches

Askew (2015) focused on place value in Grade 2 in South Africa. He argued that within a context focused around whole-class teaching, it is still possible to engage learners with mathematics in ways that go beyond merely reproducing procedures demonstrated by the teacher.

Cao et al. (2015) presented the characteristics of the Chinese traditional approach from the perspectives of content, organisation, the arrangement of teaching, ways of presenting and cognitive demand level with a special emphasis given to multiplication tables.

11.1.2.2 Knowledge of Teachers

Ekdahl and Runesson (2015) examined shifts in the nature of responses of three South African Grade 3 teachers to students' incorrect answers when teaching the part-whole relationship in additive missing number problems and discuss consequences.

Lin (2015) focused on teaching the structure of standard algorithms for multiplication with multi-digit multipliers via conjecturing as one of effective instructional approaches to teaching multiplication with multi-digit multipliers.

Barry et al. (2015) investigated the variables that determine the difficulty of an additive problem. They showed that the knowledge of variables that determine it differs considerably from one teacher to another. They justified that the roots of these differences are in the differences of teachers' pedagogical beliefs.

11.1.2.3 Curriculum

This group of contributions is not fully homogeneous. It includes papers focusing on WNA curricula in different countries, on the outcomes when applying curricula and on the influence of using different types of textbooks.

Kaur (2015) presented the primary school mathematics curriculum in Singapore, focusing on the model method, a tool for representing and visualising relationships. In Singapore, it is a key heuristic that students use for solving WNA word problems.

Wong et al. (2015) reported on Macao's 15 years of experiences of primary mathematics education, after the official handover of the former Portuguese enclave to China in 1999. They argued that no educational system can provide Macao with a ready-made curriculum model.

Sensevy et al. (2015) analysed the principles and rationale of a curriculum for WNA teaching in the first grade in France.

Brombacher (2015) reported on the situation in Jordan. He suggested that deliberate and structured daily focus on foundational whole number skills can support the development of children's ability to do mathematics with understanding.

11.1.2.4 Textbooks

Alafaleq et al. (2015) examined how equality and inequality of whole numbers are introduced in primary mathematics textbooks in China, Indonesia and Saudi Arabia.

Zhang et al. (2015) investigated four sets of primary mathematics textbooks used in Hong Kong using content analysis.

11.1.2.5 Assessment and Evaluation of WNA

Zhao et al. (2015) discussed challenges that Chinese primary teachers faced when supposed to implement classroom assessment techniques.

Gervasoni and Parish (2015) presented the results of one-to-one assessment with nearly 2000 Australian primary school students. They highlighted the challenge of meeting each student's learning needs, and demonstrated the complexity of classroom teaching.

Pearn (2015) compared the reactions of the Grade 4 teachers in one school (with the same curriculum) with their students' results on a WNA test.

11.1.3 *The Discussion in the Working Group*

The eight 1-hour sessions in the working group were organised in two different forms. The first five sessions were devoted to the discussion of the participants' accepted papers. The papers were grouped according to their topics dealt with: teaching approaches, knowledge of teachers, curriculum, curriculum and textbooks and assessment of WNA. Then three discussion sessions followed. Their themes of discussion were: teachers' knowledge of their students' understanding, performance and personality traits that can help teachers plan for effective teaching strategies;

multicultural approaches and traditions of teaching WNA; the role of textbooks and artefacts in teaching WNA; and the role of custom-made curriculum to improve the learning of WNA. The work was organised partly in the mixture of small group and plenary discussions.

The programme was enriched by the contribution of Marianela Zumbado Castro from Costa Rica (CNAP). Her presentation covered the information about the important development of number meaning in the Costa Rican mathematical programme. She highlighted approaches to calculations and approximations and the use of multiple representations in troubleshooting. These domains were covered from an eminently pragmatic perspective that emphasised student action. She emphasised that numbers occupy a big place from first to sixth graders, in order to promote mathematical processes and positive attitudes for its proximity to the context and its close connection with the other areas.

It is obvious that the topics dealt within WG4 were not disjoint with other WGs. There were overlaps with other working group topics as well as with the panel about teacher education. However, the common topics were tackled from different perspectives in each part of the programme and can be seen as complementing each other.

11.2 A Mathematics Lesson Focused on Addition Calculations with Two-Digit Numbers at a Primary School in Macao

11.2.1 Introduction

Teachers in Macao in common with primary school teachers across the world are working to transform their approach to teaching mathematics. They have a strong focus on students learning mathematics with deep conceptual understanding and developing creative thinking. In this chapter, we aim to explore issues in the teaching of arithmetic with reference to an illustrative lesson that we observed at a primary school in Macao in June 2015. The Grade 1 class we observed were all enthusiastic and well focused on the activities and learning throughout the lesson. This school, we were told, aims to ensure that the students will be well behaved, enjoy their lives and be good at creative thinking for the future. The mathematics team of 14 teachers was described by the principal as progressive and innovative. They meet together in different levels at least once per week to share their objectives and activities. They also engage in research practices focused on school-based studies of teaching aimed to promote positive changes in teaching and learning. Every teacher is responsible for teaching one demonstration lesson and observing 20 lessons in an academic year so that the mathematics teachers can learn from each other. The school also organises training for elite mathematics teams from the kindergarten to the grade 9 who join mathematics competitions. This activity aims to enhance logical thinking and project-based practice.

11.2.2 The Lesson

The Grade 1 students we observed have five mathematics lessons per week and one mathematics reading lesson per week (a mathematics reading lesson involves stories and written problem-solving, mathematical games, project-based activities and hands-on activities). The lesson began with a *lead in* stage during which students engaged in 3 min of mental calculation practice. The lesson proceeded with several stages during which the students explored a range of situations and strategies for adding two-digit numbers. Throughout the lesson, the teacher circulated to observe and discuss the students' strategies and to select students to describe and explain their calculation strategy to the whole class. In one stage of the lesson, the students worked in fours to use models to represent the calculation and solution. A variety of real-world calculations and bare number calculations were investigated and solved and discussed. The Grade 1 students we observed were all enthusiastic and well focused on the activities and learning throughout the lesson (Electronic Supplementary Material: Sun 2017b).

The setting and sequence of activities of the lesson are summarised in Table 11.1 shown below.

Table 11.1 Setting and sequence of activities of the lesson

<i>Seating organisation for the lesson</i>	See Fig. 11.1
The class of 22 Grade 1 children (6-year-olds) sat in pairs at their desks.	
<i>Introduction and welcome</i>	See Fig. 11.2
The lesson began with a warm greeting from the teacher and a respectful bow from the students.	
<i>Stage 1 lead in: fluency with number facts</i>	See Fig. 11.3
The first activity in the lesson (the lead in stage) focused on the students practising number facts – number combinations for ten. The students were shown a set of number facts to solve and recorded their answers. This practice was timed with students recording when they completed all the calculations. The teacher roved around and observed the students as they worked.	
The answers were corrected as a group with the stated aim being for the students to improve their previous score and time. The teacher enthusiastically encouraged the students to improve and asked them to state if they had improved their time and score.	
<i>Stage 2 situation setting: addition of a two-digit number and a one-digit number without regrouping – using pictorial representations of realistic contexts</i>	See Fig. 11.4
In this section of the lesson (situation setting), the teacher presented a realistic situation for the students to explore. The first problem showed a pictorial representation of four packets of ten candies and three single candies. They needed to work out the total: $40 + 3 = 43$.	

(continued)

Table 11.1 (continued)

<p>The next situation presented was a pictorial representation of candies organised onto trays of ten and loose candies. The calculation was $25 + 2 = 27$. Once the problem was solved the teacher guided a discussion about the calculation strategies used. The photo shows splitting the 25 into tens and ones and then grouping the ones to calculate the total easily.</p>	See Fig. 11.5
<p>Finally, the students considered a situation involving pencils organised into boxes of ten and some loose pencils. The calculation involved two-digit numbers. The solution discussed by the teacher and students considered grouping the boxes of ten together and adding the number of loose pencils.</p>	See Fig. 11.6
$25 + 20 = 45$	
$20 + 20 + 5 = 45$	
<p><i>Stage 3 group counting and sharing: addition with two-digit numbers and one-digit number (with regrouping ones)</i></p>	See Fig. 11.7
<p>This stage of the lesson was described as the group counting and sharing stage during which the students were expected to communicate, conceptualise and inquire. The context was 'party time'; materials (candies) were used to represent the situation and the calculation strategies for $24 + 9 = 33$. The students worked in groups of four to discuss the possible strategies for this calculation, while the teacher moved between the groups to observe, listen in and discuss the strategies. Students were selected to come to the front of the class and explain their strategies using the document camera and interactive white board. The teacher explored three different strategies with the class. She had anticipated these strategies before the lesson and prepared the posters for display.</p>	
$23 + (1 + 9) = 33$	
$20 + (4 + 9) = 33$	
$(24 + 6) + 3 = 30 + 3$	
<p><i>Stage 4 Practice Stage: calculation competition</i></p>	See Fig. 11.8
<p>This stage of the lesson had three components. During Practice Stage 1, the student found solutions to a set of problems while the teacher circulated to observe and discuss the strategies. The teacher again selected several students to come to the front to explain their calculation strategies. The teacher highlighted carefully the different strategies used. However, after only completing one of the four calculations on the board, the teacher moved to Stage 2. In Practice Stage 2 the students worked in pairs and were asked to choose their favourite digits from an envelope to make a new two-digit number. The teacher gave them another card with the addition sign and a single digit number (9 followed by 7). The students had to add the one-digit number to their two-digit number. Several strategies were shared with the class.</p>	
<p>One child explained a calculation that bridged 100: $95 + 9 = 104$. She had some difficulty describing her strategy to the class and the teacher assisted her.</p>	See Fig. 11.9
<p>Practice Stage 3 was a return to the calculating competition (Practice Stage 1) where the students were encouraged to share their answers and their strategies.</p>	See Fig. 11.10
<p><i>Lesson summary</i></p>	
<p>The conclusion of the lesson was a summary by the teacher about what they had explored and learnt during the lesson. The teacher emphasised that the students could use the 'making 10' strategy to add a two-digit number and a one-digit number.</p>	



Fig. 11.1 Seating organisation

Fig. 11.2 Introduction and welcome



Fig. 11.3 Lead in: fluency with number facts

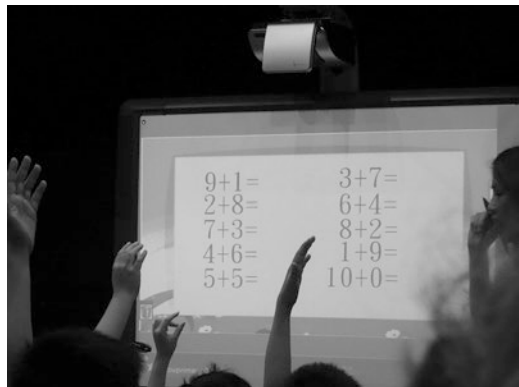

Fig. 11.4 First situation setting

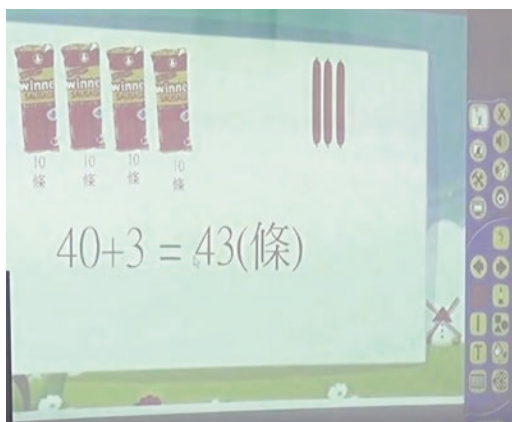

Fig. 11.5 Second situation setting

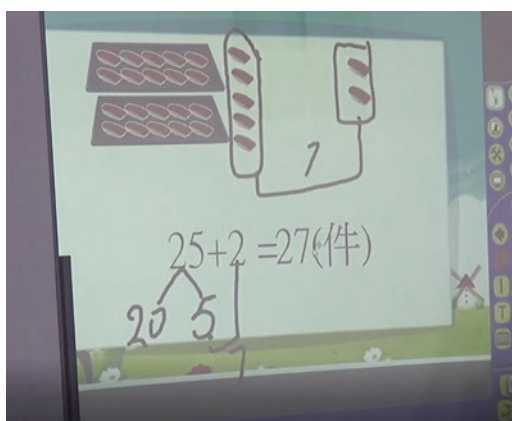

Fig. 11.6 Third situation setting



Fig. 11.7 Group counting and sharing

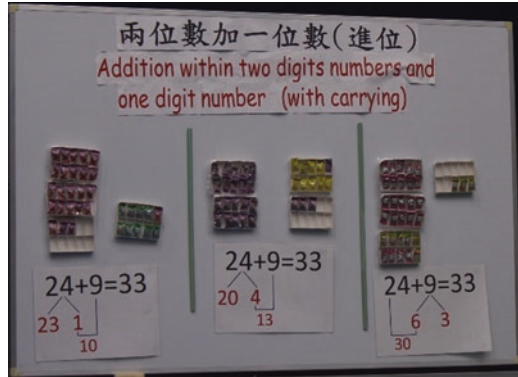

Fig. 11.8 Practice stage 1



Fig. 11.9 Practice stage 2

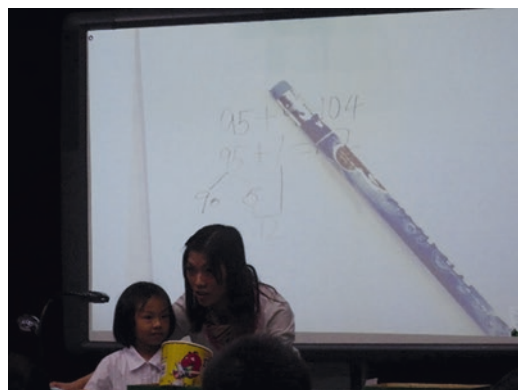

Fig. 11.10 Practice stage 3

11.3 The Impact of Teachers' Knowledge of Pedagogy, Learning Trajectories, Mathematics and Students (Cognitive, Social, Emotional, Context, etc.) on Children's Learning of Whole Number Arithmetic

11.3.1 Introduction

Many everyday calculations involve adding combinations of one-digit and two-digit numbers. This is so whether we are shopping, measuring for sewing or a building project or analysing data in a rainfall graph. This partly explains why adding one- and two-digit numbers is a key focus in primary school mathematics education. However, approaches to teaching this type of calculation vary within and between countries. The teaching approach in many countries today emphasises children learning a variety of arithmetic strategies so that they can successfully and efficiently perform calculations mentally. However, other approaches draw upon textbooks that focus on children learning standard written methods for performing these calculations. It is important for teachers to understand the affordances and limitations of various teaching approaches for children's arithmetic learning.

11.3.2 Responding to Children's Current Knowledge of Whole Number Addition and Subtraction

The Macao lesson vignette described earlier in this chapter provides an example of an approach to teaching children to perform calculations with one-digit and two-digit numbers that would be recognised in many countries (e.g. Singapore, Germany, Australia, Canada, Thailand). The teacher used her knowledge (assessment) of the students' current mathematics knowledge and pedagogy to select tasks with an appropriate level of challenge and that aligned with the curriculum expectations.

She made a concerted effort to motivate the students to engage in the lesson activities and work hard to improve their knowledge, and she was encouraging of the students' efforts to learn. The teacher provided the children with time to work on their own, time to work in small groups to discuss ideas and solutions and time to observe and listen to the solutions presented by several students. This suggests that she may be influenced by social-cultural perspectives (e.g. Vygotsky 1980) in designing the lesson structure. However, this may be the teaching norm in her school community. With respect to the tasks, the teacher provided a balance between tasks that involved bare number calculations and those that were connected to everyday situations. There was also the opportunity in the lesson for children to use materials and pictures to model their solutions processes to support their mathematical reasoning. There was an overarching focus on the children understanding the solution strategies they were using or viewing. However, in contrast to the approach in Singapore (Kaur 2015) and advocated by Bruner (1960), there was little use of materials being used to assist individual children's learning progress from arithmetic reasoning based on concrete representations through to pictorial and abstract representations. In contrast, the approach in the Macao lesson required all the children to engage with concrete, pictorial and abstract models at set points in the lesson. There was no sense that the teacher was using formative assessment to select concrete, pictorial or abstract models for individual children based on their current understanding or to encourage the children to select these different representations themselves.

One set of tasks in this lesson involved the students performing calculations with numbers such as $25 + 9$. Pictures of snacks in boxes of ten and loose ones were used to represent the quantities and to model the various solution processes that were predetermined by the teacher. This set of solutions was elicited from the children and discussed as a class group to build understanding and provide children with examples of strategies they may not have spontaneously considered. This enabled the class to discuss the advantages of various strategies in relation to the numbers involved. This teaching approach of inviting children to demonstrate and discuss various solutions is widely used in countries such as Japan (Murata and Fuson 2006), the Netherlands (RME; van den Heuvel-Panhuizen and Drijvers 2014), Germany (Selter 1998) and Australia (Clarke et al. 2002).

One advantage of all the children in a class performing the same calculations is that they can all participate in a meaningful discussion about the various arithmetic strategies used. However, tasks such as $25 + 9$ do little to develop creativity, challenge or persistence. An alternative approach is to use an open task that enables children to create and discuss a range of solutions. For example, the students may be asked to create a set of solutions for the task, 'Ivy added two numbers and the sum was more than 32. What might the numbers be?' This open task encourages the students to persist in producing a range of solutions that are creative and complex enough to challenge them to think hard. The solutions and arithmetic strategies can then be discussed as a class to extend the understanding of all. This approach is advocated by Sullivan et al. (2015).

The challenge for a teacher during a lesson such as the one described earlier is to plan how the learning may be differentiated and how the lesson can develop creativity, which was a stated aim of Hou Kong Primary School in Macao and is highlighted as an important goal of mathematics education in many international settings. In the observed lesson, it seemed that all students were able to successfully perform the calculations, but some were clearly more confident than others, and some children may have been able to solve more complex problems, given the opportunity. However, the tasks and teaching actions were not adapted to respond to any formative assessment data collected by the teacher during her observations or discussion with children. This issue of task differentiation and developing creative mathematical thinking are important considerations when considering highly effective teaching of whole number arithmetic. Further, in many countries, where class sizes are very large, the differences in the knowledge of the students may pose the teacher with challenges. Thus differentiating tasks and instruction is an important role for the teacher when children are learning whole number arithmetic.

11.3.3 Differentiating Instruction Based on Children's Current Knowledge

Children's development of heuristic strategies for addition and subtraction has been well described (e.g. Steffe et al. 1988; Murata and Fuson 1997). Such research formed the basis for describing the six addition and subtraction strategies growth points established during the Early Numeracy Research Project (Clarke et al. 2002) to describe children's learning in this domain. Growth points are established for a child following assessment by the teacher using a detailed scripted one-on-one assessment interview (Clarke et al. 2002). This is a common assessment approach in Australia and New Zealand (Bobis et al. 2005). A feature of assessment interviews is that they enable the teacher to observe children as they solve problems to determine the strategies they used and any misconceptions (Gervasoni and Sullivan 2007). They also enable teachers to probe children's mathematical understanding through thoughtful questioning (Wright et al. 2000) and observational listening (Mitchell and Horne 2011).

Growth point results for nearly 2000 Grade 1 to Grade 4 students (Fig. 11.11) collected during the Bridging the Numeracy Gap Project (Gervasoni et al. 2011) confirm that there is a wide distribution of children's addition and subtraction strategies growth points in each class. These data indicate that 96% of Australian Grade 1 children, 75% of Grade 2 children, 46% of Grade 3 children and 30% of Grade 4 children used counting-based strategies for calculations, such as $4 + 4$ and $10 - 3$. The fact that so many Grade 4 children remain reliant on counting strategies and concrete models for calculating and that almost no Grade 4 students could solve mental calculations involving two-digit and three-digit numbers (growth point 6) is at odds with the tasks typically found in Grade 4 textbooks that involve calculations

2011 Addition and Subtraction Strategies Growth Points Distributions Gr 1-Gr 4

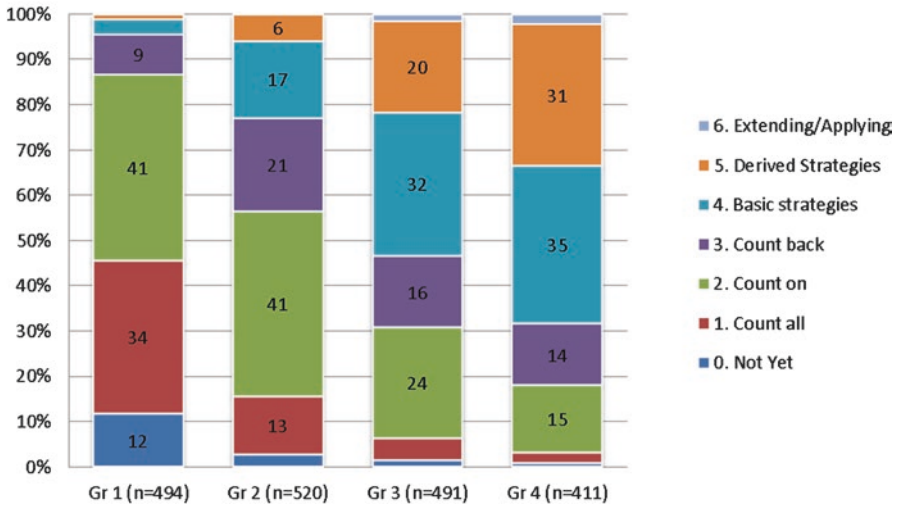

Fig. 11.11 Addition and subtraction growth point distribution for Grade 1–4 children

with much larger numbers. Data such as these demonstrate the need for teachers to understand the current knowledge of students through observation of their calculation strategies, understand the typical developmental pathway in this domain and understand the teaching strategies that respond to the individual needs of students so that they can differentiate tasks. This is not possible if teachers only use written tests (Clements and Ellerton 1995) or one textbook for a class that does not differentiate learning and extend understanding. Rather, if teachers observe that a child uses a count-all strategy (growth point 1) and refer this to a learning framework, then they can appreciate that a child’s shift to using a count-on strategy (growth point 2) or abstract reasoning strategies (growth point 4) requires the teacher to hide some of the physical models to prompt children to produce a mental image that enables them to count-on or reason abstractly.

In summary, there is no single ‘formula’ for describing children’s whole number knowledge or the instructional needs of children in a particular grade. Meeting the diverse learning needs of children requires teachers to be knowledgeable about how to identify each child’s current mathematical knowledge and how to customise their teaching accordingly. This calls for rich initial and formative assessment tools capable of revealing the extent of children’s whole number knowledge and calculation strategies and an associated framework of growth points capable of guiding teachers’ curriculum and instructional decision-making. Assisting children to learn mathematics is complex, but teachers who are equipped with the pedagogical knowledge and actions necessary for responding to the diverse needs of individuals are able to

provide children with the opportunities and experiences that will enable them to thrive mathematically.

11.4 View of Lesson through the Lens of Variation Theory

Variation theory has come to the foreground in the last decade in different parts of the world (Huang et al. 2006) as a lens through which the classroom learning can be designed, described and analysed. First we look at the ‘indigenous’ approach to variation problems (Sun 2011a, b, 2016), in order to give an insider’s perspective on the lesson (design and functioning), and second we situate the lesson within the international debate (e.g. Marton et al. 2004) about the observed lesson.

11.4.1 *The Insider’s Perspective: ‘Indigenous’ Variation Practice*

In this section, we examine the lesson through a lens of ‘indigenous’ variation practice as a means of providing the insider perspective, in order to enhance comprehensive understanding of the lesson. In this section, we mainly focus on the situation of the candy box problem. In order to understand the classroom process, it is necessary first to describe the past experience of the students, which followed the Chinese curriculum as it is described in Chinese textbooks. The importance of textbooks in Chinese curriculum must be emphasised, as teachers follow the textbooks’ directions (which draw on the standards) very carefully. As said in the previous sections, this lesson took place close to the end of the school year; hence, students were already familiar with the previous content.

11.4.1.1 The Prior Students’ Knowledge

The students’ previous knowledge about different cases of addition and subtraction had been developed, fostering grouping, regrouping and ungrouping, following the Chinese tradition. Consider the following examples of activities taken from their textbook for the first months of the first grade (Fig. 11.12).

The image on the left provides a good example of *explicit variation*. In the first line, there is the standard notation for decomposing 10 in different ways. Then, in each of the following lines, there is a scheme (the problem situation, given in iconic form) referring to one of the above decomposition. Each problem is interpreted in different ways, according to the indigenous variation practice (OPMC, i.e. one problem, multiple changes, Sun 2011b), hinting at addition and subtraction together. The same problem is focused at the same time with different interpretations, creating a

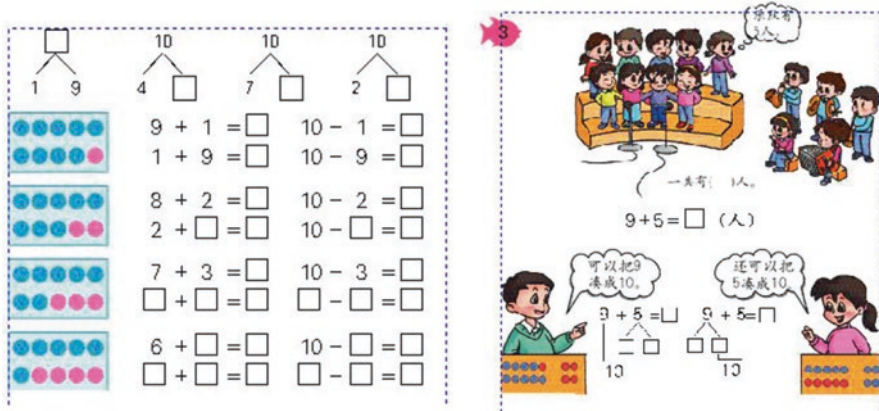

Fig. 11.12 Examples introducing the decomposition of 10 in the Chinese textbook (Mathematics Textbook Developer Group for Elementary School, 2005, vol. 1)

very strict link between addition and subtraction and a focus on algebraic thinking (relations between numbers). In the same image, another explicit variation appears increasing the quantity of missing numbers to be detected and changing their position in the mathematical expressions. This is expected to be done in the same lesson as one textbook page is used in one lesson. This approach is very different from other ones practised in some Western countries, where addition and subtraction may be taught separately (see Sun et al. 2013 for Portugal; Bartolini Bussi et al. 2013 for Italy).

The image on the right exploits the standard notation for decomposing 10 in order to solve, in different ways, the addition $9 + 5$ with regrouping (OPMS, i.e. one problem, multiple solutions, Sun 2011b).

Besides that, students know already how to add tens and how to add two-digit numbers without regrouping. Hence, the students knew what was necessary to handle the situation of the day, concerning the candy boxes and the addition with regrouping $24 + 9$.

11.4.1.2 The Lesson Plan: The Situation of the Day

According to the framework of Chinese open classes (Chap. 16), the lesson plan was given to the international observers a few days in advance. It contained details about the organisation, the teaching topic (addition within two-digit numbers and one-digit number with regrouping), the learning objectives and the students' previous knowledge (Bartolini Bussi and Sun 2015).

The situation of the day was the problem of the candy boxes: it was carefully described in the lesson plan (excerpt) (Table 11.2).

Table 11.2 The lesson plan (excerpt)

Situation setting	(a) Teacher gives a situation to the class. ‘There are many guests in our school today. So, Miss Amanda prepares some food for them. Class, can you help me count the food as fast as you can?’	15 min
Problem solving	(a) Students work in groups. (b) Provide some candies to each group and let them count.	
Group counting and sharing (communication, conceptualising, inquiring)	(a) T invites some group to report their finding about how to count the candies altogether. (b) Give comments to the groups and use the multimedia to show three different ways to count the candies. <i>The first way of putting candies altogether</i> There are 24 candies on the left, and then there are 9 candies on the right. Next, encourage students to investigate and move 4 candies on the left and 6 candies on the right to ‘making 10’. Finally, 30 candies plus 3 candies equals 33 candies altogether. <i>The second way of putting candies altogether</i> There are 24 candies on the left, and then there are 9 candies on the right. Next, encourage students to investigate and move 1 candy on the left and 9 candies on the right to ‘making 10’. Finally, 23 candies plus 10 candies equals 33 candies altogether. <i>The third way of putting candies altogether</i> There are 24 candies on the left, and then there are 9 candies on the right. Next, encourage students to investigate and move 4 candies on the left plus 9 candies on the right equals 13 candies. Then, there is a ‘making 10’ in 13. Finally, 20 candies plus 13 candies equals 33 candies altogether.	

The three mentioned ways of ‘putting candies altogether’ hint at different ways of ‘making 10’:

- To increase 24 to 30 (3 tens).
- To increase 9 to 10 (1 ten).
- To decrease 24 to 20 (2 tens).

The teacher knew in advance that some students might have difficulties; hence, she was ready to encourage students, forcing the grouping strategy, using the concept of ‘making 10’.

11.4.1.3 The Functioning in the Classroom

The time planned for the solution was very short (15 min). However the students succeeded in solving the problem finding the three solutions anticipated by the teacher in a shorter time. The process may be outlined looking at the transcript (translated from Cantonese). The final solutions produced by the groups are in the figure of the Stage 3.

- 00.00 Here you have some candies, we can count how many candies, each group has candies boxes. Put on the table and calculate. Think how to use the candies and find the result. You can split candies and move between the boxes on the left and on the right.
- ... Students work in small groups.
- 02.14 Have you finished? Good job! And you? Have you finished? And you? Good job!
- 02.32 Very fast! Very good!
- 02.39 Let's look together. Turn to this direction (the whiteboard).
- ... The first solution: $24 + 9 = 23 + (1 + 9) = 33$
- 03.07 Let's look how she did. Hang to the board. Tell them how and why you did this way. To take away the group of 4 and put there. Why? I understand, in this way you have on the right the sum 10, on the right is three groups of 10, 30, right? All together is 33.
- 04.00 Do you have different methods? Did you think another way? Raise your hands. Did you think another way? Please, come here, carry your boxes.
- ... The second solution is given: $24 + 9 = 20 + (4 + 9) = 33$
- 06.05 Good job! Are there other methods? Have you thought in a different way?
- ... The third solution: $24 + 9 = (24 + 6) + 3 = 33$
- 08.03 Many solutions, many different solutions. Are there different solutions? How did you move the candies? This is the same as the first method. Other solutions? How did you do? It's the same. You also. Other solutions? Do you have other methods? Let me know.
- 09.00 In mathematics is there only one solution?
- Voices No no no.
- We may have many different solutions. Yes, you have made different solutions for this problem. To make the addition of a two-digit number and a one-digit number we may use different ways to group and move and get the same result.
- Later ...
- 31.43 In mathematics is there only one solution? You may use any method, you have only to find the same result and you look for the fastest method.
- (Electronic Supplementary Material: Sun 2017a, b)

It is worthwhile to observe how the teacher highlights the variation (one problem, multiple solutions (OPMS)) that seems to be the most important global message of the lesson, besides the technique of grouping-ungrouping. Variation of the 'making 10' solution is emphasised and reinforced in other episodes of the lesson, when other problems to be solved orally or in writing are given and are reconsidered at the end (min. 31.43). The coherence between the lesson plan and the realised interaction is very high. According to some scholars (Wang et al. 2015), 'recent international studies in mathematics education have identified a high degree of instructional coherence as a distinguishing feature in classrooms in China' (p. 112). The teacher's discourse showed a high degree of coherence throughout the lesson and, apparently, the students developed a sense of what was going on, showing choral answers to some questions.

11.4.1.4 A Short Summary

In this section we have tried to give an insider perspective of an ‘indigenous’ pedagogical practice. The practice, namely, variation problems, is known widely in Chinese mathematics curricula as ‘one problem, multiple solutions’ (OPMS, 一題多解, varying solutions), ‘one problem, multiple changes’ (OPMC, 一題多變, varying conditions and conclusions) and ‘multiple problems, one solution’ (MPOS, 多題一解, varying presentations). We have seen examples of the first two above. A more comprehensive summary of this kind of variation problems is in Chap. 3. A complete discussion and comparison with Marton’s variation theory is in Sun (2011b). Variation practice aims at abstracting and generalising, focusing on relationships between numbers rather than on arithmetic operations. This is consistent with the aim of developing algebraic thinking (Cai 2004; Sun 2016). This ‘indigenous’ pedagogical practice has clear boundaries that allow one to uncover how variation practice has been and is now used in Chinese classrooms and a true operational effectiveness that might be used to transpose it to other contexts (Bartolini Bussi et al. 2013). An example of transposition from China to Italy is discussed in this volume (Chap. 3).

11.4.2 A Westerner’s Perspective: Marton’s Variation Theory

It must be emphasised that the following account is a particular ‘reading’ of the lesson and in particular a reading of deliberate intent behind the selection and structuring of the examples offered to the students to consider. Such a *post hoc* interpretation is not meant to be ‘reading the mind’ of the teacher – it could well be that the actual rationale behind the choice of examples bears no resemblance to the interpretation presented here. The intent, however, is not to definitively pronounce what was behind the design of the lesson, but to use the lesson as a starting point for thinking about lesson design and how variation theory (in the sense developed by Ference Marton) might be helpful in designing lessons that provide sound opportunities for learning whole number arithmetic and inform the conversation on what mathematical knowledge for teaching needs to be brought to lesson design.

The starting point is the definition of an exercise as put forward by Watson and Mason (2006a), that is, an exercise is ‘a collection of procedural questions or tasks’. Thus, rather than examining the separate questions that learners work on in a lesson, these are collectively regarded as contributing towards a set, an exercise, that may be more or less mathematically and pedagogically structured. Thus, the lesson observed had as a major exercise a number of discrete questions all based around adding a single digit to a two-digit number and that the selection, ordering and ways of working within this exercise led to a coherence in the lesson that amounted to more than the sum of the parts.

To examine this, two particular episodes in the lesson are looked at in detail: the working on the problem of 24 sweets plus 9 sweets and the sequence of calculations

where learners chose their own two-digit number to work with. Central to this analysis is an exploration both of how the teacher worked with highly interrelated example sequences (Watson and Mason 2006a) and of the ways of simultaneously working with horizontal relationships within examples and vertical patterns between examples (Watson and Mason 2006b).

11.4.2.1 Variation Theory

Variation theory (VT) as developed by Ference Marton and colleagues (Marton et al. 2004) is a *theory of learning*, not an all-encompassing theory of pedagogy. VT, for example, sheds no light on whether group work is better than individual work or whether physical materials are more useful than pictures or images, although VT theorists acknowledge that these other features of the learning environment are important. The overall aim of VT as developed by Marton and colleagues is to attend to aspects of learning that focus on the specific mathematical content, distinguishing VT from other theories of learning that provide accounts of how learning occurs that are independent of what actual content is expected to be learnt. As a group of teachers and researchers in Hong Kong engaged in ‘learning studies’ that draw on VT to look at how diverse classroom communities can learn particular content note:

Contrary to the belief of some educational theorists, therefore, we believe that one simply cannot develop thinking in isolation from the objects of thought. Learning is always the learning of something, and we cannot talk about learning without paying attention to what is being learnt. (Lo et al. 2005, p. 14)

It is beyond the scope of this chapter to go into all the details of VT, but central to the argument here are the constructs of objects of learning, discernment and variation.

VT acknowledges the intentionality of teaching: teaching is always directed towards specific learning ends or, in the language of VT, objects of learning. An object of teaching is never unitary: any teaching activity is always, and inevitably, directed towards at least two objects of learning. There is the direct object of learning – in this lesson, the addition of two numbers. It is this that learners are usually most focused upon as revealed through their answers to the question, ‘What did you learn today?’ Answer: ‘How to add’. But every teaching activity also encompasses one or more general capabilities that are broader than the specific object of learning, for example, interpreting or generalising. These comprise the indirect object of learning (Marton et al. 2004).

According to Bowden and Marton (1998), our learning is a result of what we are able to discern, distinguish. But we can only distinguish between things when there is variation in our experiences:

When some aspect of a phenomenon or an event varies while another aspect or other aspects remain invariant, the varying aspect will be discerned. In order for this to happen, variation must be experienced by someone as variation. (Bowden and Marton 1998, p. 35)

Variation is the key to being able to discern. As Watson and Mason (2006a) argue, any aspect of a task or situation that it is hoped learners will discern (the lived object of learning) ‘is more likely to be discerned if its variation is foregrounded against relative invariance of other features’ (p. 98). In other words, what is not varied is as important to attend to as what is varied. So the teacher is in control of the ‘enacted object of learning’ through the structuring of the ‘example space’ (Watson and Mason 2005), that is, a collection of examples that fulfil a specific function (Zazkis and Leikin 2007). And equally, if too much is varied, then either nothing may be discerned or inappropriate or irrelevant features attended to. As Runesson (2005, p. 72) notes, ‘studies have shown that exposure to variation is critical for the possibility to learn, and that what is learnt reflects the pattern of variation that was present in the learning situation’.

11.4.2.2 Variation Within the Lesson

The first example in the exercise of adding a single digit to a two-digit number with carrying in the main teaching part of the lesson was based around the party time problem of adding 9 sweets to 24 sweets. Groups of learners were given 24 candies as two full boxes of ten and a box with only four, together with a box of nine. As the groups worked on solving the problem practically, the teacher roamed around noting the different methods and selecting which groups she was going to invite to share their approach with the class. As noted in the account, the teacher had already prepared posters for three strategies and so was, presumably, looking for groups whose strategy fitted with what she had anticipated.

Each group asked to demonstrate their solution started by putting up on the board the two boxes of ten and the four units and the box of nine to the right of these and modelling with the candies what they had done. In this way, three different partitionings of one of the numbers was elicited: partitioning the 24 into $23 + 1$ and effectively doing $24 + 9 = (23 + 1) + 9 = 23 + (1 + 9) = 23 + 10$ (although recorded differently, but consistently across the three solutions, by the teacher). Similarly, there was $24 + 9 = (20 + 4) + 9 = 20 + (4 + 9) = 20 + 13$ and $24 + 9 = 24 + (6 + 3) = (24 + 6) + 3 = 30 + 3$.

Here in one example we see careful variation and non-variation. What was kept constant was the calculation and the partitioning of one of the numbers in a way that anticipated creating a multiple of ten to be added to another number. Thus, while the direct object of learning was to calculate the sum, indirect objects implicitly worked with included the associative rule for addition, equivalence and the simplifying of calculations by creating a multiple of ten. All of this, we suggest, was enacted through carefully working horizontally within one example and carefully determined variation within this horizontal working. So while it might be argued that the teacher, in predetermining the solution methods that she sought, limited the opportunity for attending to other things such as learner creativity, from a VT perspective, the control exercised by the teacher here is central to directing what might be discerned by the learners.

The next set of examples in the exercise that we want to examine is the sequence where learners used digit cards to make their own two-digit number. While the teacher made some play of appearing to randomly select a digit for them to add to their number, it seemed from her actions that the pulling out of 9 was not entirely random. Again, as the learners were working, the teacher moved around and chose three to come and show, now using a visualiser, their working (recreating this, not simply showing the final working). The fact that the third example – $95 + 9$ – drew gasps of delight from the class suggests again that the choice and sequencing of the three children invited to share their solutions were carefully considered by the teacher. From the perspective of VT, what was now varied was the choice of two-digit number, but adding 9 (and subsequently 7) kept constant. The choice of 9 again not only, in being close to ten, may have encouraged attention to making a multiple of ten, but also only made a small vertical move from the three methods of adding $24 + 9$ still displayed on the board. Thus, learners were encouraged to attend to how they can build on what they have just done, rather than having to deal immediately with both numbers being varied.

So although this lesson can be read as being very tightly controlled by the teacher, that control can be read as located in a carefully thought out exercise, a carefully constructed example space, designed to help learners develop effective methods of calculating.

11.4.3 Comparison

When comparing the two approaches to variation theory presented in Sects. 11.4.1 and 11.4.2, there are many similarities. But there can also be found substantial differences, the roots of which can be briefly summarised as follows: Marton's theory is a theory of learning (Kullberg 2010), while indigenous variation practice is a method of task design for teaching. More information about variation theory can be found in Chap. 3. A comprehensive book on teaching with variation has been published by Huang and Li (2017).

11.5 View Through the Lenses of the Theory of Didactical Situations

One efficient tool for analysing teaching episodes is Brousseau's (1997) theory of didactical situations (TDS). In TDS, two different types of knowledge are distinguished: *connaissance* (a knowing) and *savoir* (knowledge). In the text of this section, we use the English translations of the French terms introduced in Brousseau (1997, p. 72, Editors' note): 'The former refers to individual intellectual cognitive constructs, more often than not unconscious; the latter refers to socially shared and recognised cognitive constructs, which must be made explicit'.

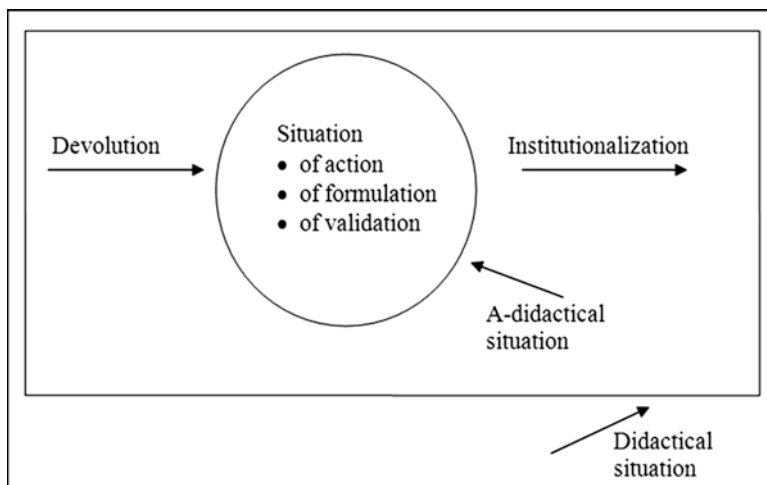

Fig. 11.13 Scheme of a didactical situation

11.5.1 Didactical Situations

Let us summarise the main characteristics of a didactical situation as used in TDS (Brousseau 1997; Brousseau and Sarrazy 2002). In didactical situations, the teacher organises a plan of action which makes clear her intention of modifying or causing the creation of some knowledge for the student, for example, and which permits her to express herself in actions. Certain didactical situations, the so-called *a-didactical situations*, are (intentionally) partially liberated from the teacher's direct interventions. An *a-didactical situation* is the autonomous part of an individual or collective activity of students; and student's adaptation to this situation shows the *knowing* involved.

The theory classifies situations according to their structure (action, formulation, validation, etc.) which determines different types of knowledge (implicit models, languages, theorems, etc.). Figure 11.13 schematically records the structure of a didactical situation.

The *a-didactical situation of action* is a situation in which a knowing is manifested only by decisions and by regular and effective actions on the *milieu*¹ and where it is of no importance to the evolution of the interactions with the *milieu* whether the actor can or cannot identify, make explicit or explain the necessary knowing.

The *a-didactical situation of formulation* puts at least two actors into relationship with the *milieu*. Their common success requires that one of them formulates the knowing in question for the use of the other, who needs it in order to convert it to an effective decision about the *milieu*.

The *a-didactical situation of validation* is a situation whose solution requires that the actors establish together the validity of the characteristic knowledge of this situation.

¹The word '*milieu*' denotes everything which acts on the student and/or on which she acts.

The institutionalisation of a knowing reveals itself by the passage of this knowing from its role as a means of resolving a situation of action, formulation or validation to a new role, that of reference for future personal or collective uses and, thus, as a piece of knowledge.

Devolution is the process by which the teacher manages in an a-didactical situation to put the student in the position of being a simple actor in an a-didactical situation.

11.5.2 Elements of Didactical Situations in the Lesson

For tracing the features of TDS in the lesson, let us analyse Stage 3 (group counting and sharing: addition with two-digit numbers and one-digit number with regrouping ones). It followed the stage during which children got acquainted with a scheme describing adding two numbers without regrouping (Fig. 11.14).

The objective of Stage 3 was represented by adding $24 + 9$. The expected activity was explained by the teacher on the interactive board in front of the classroom. Tens were represented by a box with ten rounds in a rectangle. Therefore 24 and 9 occurred as the scheme on Fig. 11.15 (devolution).



Fig. 11.14 Representations on the whiteboard

Fig. 11.15 Representation of 24 and 9

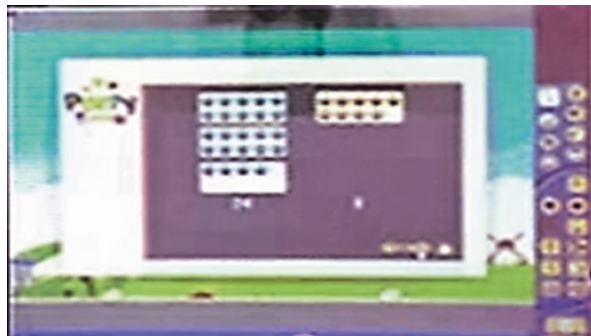

Fig. 11.16 Candies in boxes

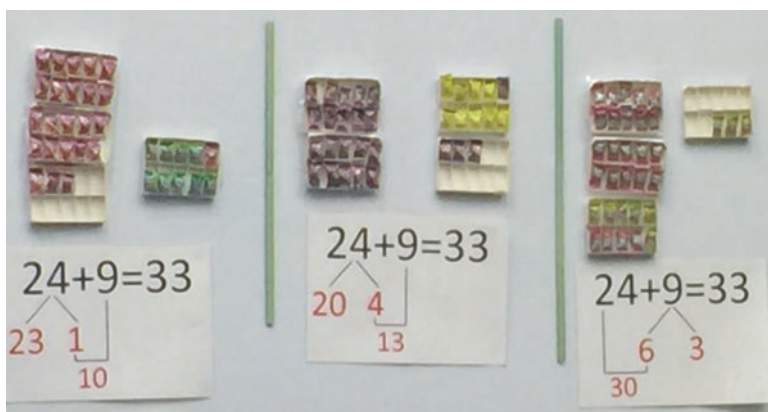

Fig. 11.17 Different representations of $24 + 9$

Students worked in groups. They were provided with boxes for ten candies. Twenty-four violet candies were placed in two full boxes and the third box contained four candies and six empty slots (Fig. 11.16). In another box, nine yellow candies were stored. When looking for the sum, students tried to add more candies in one box that was not full to have complete it to ten candies (of candies of both colours). Thus, there are three valid procedures to deal with the boxes (see Fig. 11.7). The teacher circulated through the classroom and recorded procedures applied by individual groups. From time to time, she interfered in the work of a group. By acting, students built the knowing of regrouping for the addition of $24 + 9$. The a-didactical part of the situation is rather limited and does not offer too much freedom for students to act in relationship with the milieu (even filling in the boxes is already predetermined by providing groups with the given number of boxes and placing candies in a certain way in them).

The formulation and validation of the developed knowing were organised together as a whole class activity managed by the teacher. She asked representatives of groups to come to the front and model their procedure with the boxes of candies

they used. At the same time, she projected a schematic description of the presented procedure and added the symbolic record of the solving strategy under the boxes fastened on the board (Fig. 11.17).

Institutionalisation was realised in the form of solving similar problems. This time, students worked in their exercise books. Individual students presented then their calculations (projected their record and explained it). The teacher did not finish with the presentation of one procedure but elicited the occurrence of others. She pushed children to work as fast as possible (the speed of solving looks to be an important factor in Chinese classrooms). The teacher insisted on students' independent description and explanation of each step of their solving procedure.

The process from the work with models to the 'abstract' way of solving the problem using mathematical symbols showed to be smooth and understandable for students.

11.6 Classroom Assessment in Whole Number Arithmetic

Mathematics teachers need to assess their students' learning progress in whole number arithmetic to be able to provide pertinent guidance during the learning process. Not only is this knowledge necessary, it is even impossible to teach without it, because teachers' teaching should build on and link to what the students already know. In other words, teachers need to have insight into students' solution strategies reflecting their mathematical thinking (Gearhart and Saxe 2005). The guidance teachers provide in their mathematics classes can be more or less effective for stimulating students' understanding, depending on whether their instruction is attuned to students' needs and possibilities for further development (cf. Butterworth 2015: '[g]etting the correct assessment is fundamental for selecting the appropriate intervention' (p. 28)). In a continual striving for providing the best possible explanations to students, teachers need to know at practically every particular moment in their classes of every single student where they are in their understanding. This echoes Schoenfeld (2014) statement that, '[p]owerful instruction 'meets students where they are' and gives them opportunities to move forward' (p. 407). Teachers can acquire insight about students' whole number arithmetic abilities by qualitative and holistic assessments, such as observing students in class and giving them open-ended tasks, providing a reliable window for knowing students' progress (cf. Black 2014). Taking this formative perspective in assessment offers teachers the possibility to adequately assess students' understanding in such a way that it directly informs their teaching of whole number arithmetic. Teachers can use the results of such formative classroom assessment to make instructional decisions, for example, to decide whether they need to adapt instruction to fit students' current mathematical understanding, repeat a particular exercise or explanation or, if students have reached a satisfactory insight, continue with their previously planned further instruction. This type of assessment is completely in 'the hands of teachers' (van den Heuvel-Panhuizen and Becker 2003, p. 683).

11.6.1 Reflection on the Possible Assessment Fragment of the Lesson in Macao

During the lesson observed in Macao there were some instances where the teacher appeared to be assessing her students' skills; she did not, however, seem to make formative use of the information that she could gather from the students' responses. The lead-in stage of the lesson could have functioned as a formative assessment technique, in the sense that through the students' answers to the different number combinations of 10 the teacher could have found out whether the students had memorised these number facts. Subsequently, she could have used this information to decide how to proceed with her further instruction. Checking students' knowledge of the combinations of 10, as she did in this lesson, is a very insightful starting point, as this understanding/knowledge is a prerequisite underlying the more complex calculations that were planned later in this lesson, i.e. addition with regrouping (crossing 10) until 100. However, as a formative assessment technique, it could have provided only limited useful information, as merely confirmatory evidence was gathered: all the different combinations were provided, ordered from $9 + 1$, $8 + 2$, etc. to $2 + 8$, $1 + 9$ and $10 + 0$. Students had to write, as fast as possible, the result of every 'calculation', i.e. 10, next to each member of the list of combinations. Evidently, this can be done in several ways, of which only one really concerns the use of previously memorised number facts. Other solution strategies are, for example, the recognition of the minor variation in the problems, and thus concluding that all answers must be 10, without calculating, or calculating all of the combinations one by one, but fairly quickly, as they are, even for Grade 1 students, relatively easy. As a fun exercise – it was a timed competition where students could register their elapsed time themselves – this activity had its merits, but it could possibly have been more informative if it were used by the teacher with a formative assessment purpose in mind. For this, to inform further instruction, it would not be necessary to neglect the memorisation and speed objectives of the calculation competition, but it would be necessary for the teacher to change her perspective from teaching or testing for the correct answer to assessing with the purpose of better adjusting her further teaching to her students' skills, level of understanding and knowledge of number facts.

11.6.2 Alternative Lead-in Activity by Using Classroom Assessment

An alternative task that could be used as a classroom assessment technique in this same context is the following. To find out if students really have learned the combinations of 10 and memorised them as number facts, an informative and interactive technique could be the classroom activity in which all the students have a red and a

green card with which they can show their (dis)agreement with a series of statements. The statements can be ‘Are these numbers together more than 10, yes (green) or no (red)? 2 and 7, 5 and 4...’ and so on, to which all the students respond instantaneously by showing a red or green card (see, for experiences with such an assessment technique in third grade in the Netherlands, Veldhuis and van den Heuvel-Panhuizen 2014, and, for the effects on student achievement, Veldhuis and van den Heuvel-Panhuizen 2015). This classroom assessment technique immediately provides the teacher with an overview of students’ understanding, not only about the correctness or speed of their answers, but also whether they are able to show their answers without hesitation or if they change their minds when looking at the cards their peers show (peer feedback). Also, through the interactive nature of this activity, room for a classroom discussion on strategies students used to decide on their agreement with the statements is created, as such enabling the teacher to provide feedback on these to the students. A further possibility provided by this assessment technique is the opening for further investigation, in the same way, of students’ understanding or knowledge of the analogous combinations of 100 or even 1000. Through this, the teacher could become more assessment aware, meaning that she could distinguish students practising from assessing them. With only this slight adaption of the lead-in activity and the teacher using a formative assessment perspective, she could have adjusted her instruction to the students’ needs even more than she already did. A different approach, focusing more on individual students, without changing the lead-in stage, is of course also possible. Such an approach was used in Australia (Gervasoni and Parish 2015) where teachers perform clinical individual assessment interviews. These interviews can provide valuable additional information on students’ instructional needs in whole number arithmetic. Likewise, the *Journal of Number* (Sensevy et al. 2015), in which individual students are regularly prompted to write down what they know about the mathematics they encountered in the preceding lessons, could be used to further enlighten the teacher about her students’ understanding.

11.6.3 Classroom Assessment and the Lesson Plan

For the teacher to use the gathered assessment information formatively, she would need to be flexible in the use of her lesson plan. When comparing the pre-established lesson plan to the lesson we observed, there appears to be a one-to-one correspondence in content, order and type of activities she proposed. Everything was very well prepared, from the concrete materials, the posters on the whiteboard, until the hidden answers to the different problems on the video-projected slides. The questions the teacher posed appeared to be mainly focused on steering the students’ responses in the direction of the prepared materials. All problems the students had to solve clearly had one, and only one, correct response. This was remarkably exemplified by the way the teacher uncovered the correct responses to the exercises; the correct answers were hiding in the presentation slides, clearly predetermined and

appeared not to be open for discussion. As such, the teaching and learning were deterministic, focused on getting the only right answer and not really open for different interpretations of the problems and different solutions. In South Africa, comparable teacher behaviour in the teaching of whole number arithmetic, consisting of mostly ignoring incorrect answers and rarely juxtaposing correct and incorrect answers, has also been observed (Ekdahl and Runesson 2015). Such an approach is quite reasonable for a scripted demonstration lesson, but is contrary to the idea of formative assessment in which lesson plans are necessarily adaptable, because the information the teacher collects about students' understanding is used to adjust the actual teaching following the assessment. The use of lesson plans in this observed Macao lesson reflects a recent finding in Nanjing, China (Zhao et al. 2015), in which Chinese mathematics teachers' lesson plans on division prevailed over the possible influence of newly gathered information on students' understanding. These Chinese teachers did use (formative) classroom assessment techniques, but seemed to be unable to divert from their lesson plans and as such did not use the assessment information formatively.

11.7 The Role of Textbooks Related to Teaching of WNA

Researchers have generally agreed that textbooks play a dominant and direct role in what is addressed in instruction. Robitaille and Travers (1992) noted that a great dependence upon textbooks is 'perhaps more characteristic of the teaching of mathematics than of any other subject' (p. 706). This is due to the canonical nature of the mathematics curriculum. Teachers' decisions about the selection of content and teaching strategies are often directly set by the textbooks they use (Freeman and Porter 1989; Reys et al. 2004). Therefore, textbooks are considered to determine largely the degree of students' opportunity to learn (OTL) (Schmidt et al. 1997; Tornroos 2005). This means that if textbooks implementing a specific curriculum differ students will get different OTL (Haggarty and Pepin 2002). Consequently, different student outcomes result, as confirmed by several studies which found a strong relation between the textbook used and the mathematics performance of the students (see, e.g., Tornroos 2005; Xin 2007).

There is no doubt about the influence of textbooks on teachers' practices related to the teaching of WNA in the primary school. Knowledge about approaches to teach WNA presented in textbooks in different educational systems can provide deep insights about the diverse ways of how WNA is taught. The WNA curriculum varies across educational systems. The degree of coupling of the intended curriculum presented in textbooks with the prescribed curriculum in official documents also varies across educational systems in the world. For example, in Mainland China (Ni 2015) and Singapore (Kaur 2015), textbooks and the corresponding teaching materials are the most important vehicles used to implement the nationally mandated curriculum. The development and publishing of textbooks is closely regulated and monitored by the central government, the Ministry of Education, and there are

only a few officially designated publishers who are allowed to develop textbooks and teaching manuals. However, this is not the case in some countries like the Netherlands (van Zanten and van den Heuvel-Panhuizen 2014) and France (Chambris 2015), where the respective governments only prescribe the content to be taught and publishers are left to develop textbooks without any restrictions. Likewise, in Australia and Germany, the curriculum is set by the states and follows a framework agreed by all the states, and textbooks are developed by publishers without any involvement of the authorities who prescribe the curriculum (Peter-Koop et al. 2015). At times, when publishers are left to produce the books with no guidance, a mismatch may occur, as Yang (2015) found that although the national curriculum in Taiwan emphasises number sense, few activities related to number sense are found in the elementary textbooks.

Furthermore, in some educational systems, teachers do use textbooks more often than others. In most countries where education authorities are involved in the production of the textbooks, e.g. Singapore (Kaur 2015), Hong Kong SAR (Zhang et al. 2015) and China (Cao et al. 2015), teachers use textbooks in teaching the WNA curriculum in the elementary grades. In other systems, for example, Australia, there may be a variety of textbooks used in the schools, but it is also common for teachers not to use a textbook at all, but rather devise their own tasks or draw on a variety of resources, including textbooks. In Germany, the vast majority of the teachers use one of the major textbooks, available for primary schools, to teach WNA (Peter-Koop et al. 2015). The same is true for Thailand (Inprasitha 2015). Changsri (2015) and Inprasitha (2015) noted that the use of textbooks that consist of mainly routine exercises, by teachers in Thailand, may be the cause of poor performance of Thai students in mathematics.

It is inevitable that cultural and traditional perspectives are present in textbooks for the teaching of WNA. In China, the *同文算指 Tongwen Suanzhi* (a treatise compiled by a Chinese scholar Li Zhi-zao and an Italian Jesuit Matteo Ricci) has had significant influence on the teaching and learning of arithmetic and pedagogical design of textbooks (Siu 2015). Likewise, the number line as found in textbooks appears to be a Western aid for teaching WNA, as traces of its use can be found in the early teaching practices of most Western countries (Bartolini Bussi 2015).

The teaching of WNA has evolved with time and this is clearly evident from textbooks. In France, the classical theory of numbers which was adapted in close terms in textbooks disappeared from the textbooks and teacher books for teacher education during the 1980s (Chambris 2015). In Singapore, since the 1980s, textbooks have adopted the concrete-pictorial-abstract approach for the learning of WNA. In addition, the model method – a tool for representing and visualising relationships – has been a key heuristic students use for solving whole number arithmetic (WNA) word problems (Kaur 2015).

Comparative studies of textbooks, both within and between countries, have also shed light on the depth and breadth of the WNA curriculum across the world. Zhang et al. (2015) found that the four sets of textbooks they studied in Hong Kong followed the same curriculum guide for the design of the teaching units, and therefore

there were only subtle differences in the structure and sequencing of content for two-digit subtraction of numbers in the books. However, van Zanten and van den Heuvel-Panhuizen (2014) in their study of two Dutch textbook series found that the textbook series reflected divergent views on subtraction up to 100 as a mathematical topic, which were subtraction up to 100 bridging a ten and subtraction up to a 100 without bridging a ten. The research by Inprasitha (2015) and Changsri (2015) on the teaching of WNA in Thai schools, adopting the Lesson study and open approach using Japanese mathematics textbooks, show how the Japanese textbooks are influencing the curriculum materials and teaching approaches for the teaching of WNA in classrooms of Thailand. Alafaleq et al. (2015) found that generally there was a high level of uniformity in the way the comparison of whole numbers was introduced in textbooks in China, Indonesia and Saudi Arabia.

Lastly, textbooks too may have their weaknesses. At times, they use notations that give rise to erroneous conclusions. For example, Cooper (2015) noted that in Israel elementary mathematics textbooks when 25 was divided by 3, the result 8 remainder 1 was written as $8(1)$, that is, $25:3 = 8(1)$. Similarly, when 41 was divided by 5, it was written as $41:5 = 8(1)$. This leads to a nonsensical deduction that $25:3 = 41:5$. Cooper suggests that if the notation was revised as $25:3 = 8(1:3)$, it would circumvent any wrong conclusions of the equivalence relationship. Textbooks also tend to treat topics as isolated units with little connection to other units (Sowder et al. 1998). Shield and Dole (2013) found that often textbooks show the algorithmic way that topics requiring proportional reasoning are addressed with little or no connection made to related topics such as decimals, ratio, proportion and percent.

The limited focus on the connections between topics inside as well as outside mathematics and the emphasis on algorithms, closed answer form and simple connections in textbooks are hot topics addressed in many documents. For example, findings in several contributions at the International Conference on Mathematics Textbook Research and Development 2014 (ICMT-2014) highlighted this problem; see, e.g. Veilande (2014) who in his comparative study of WNA problems in Latvian fifth grade mathematics textbooks and the same in Mathematics Olympiads found that generally textbook problems focused on mathematical operations and understanding, while Olympiad problems on properties and mathematical thinking. The presentation and solving of problems in textbooks has also been the main topic of the work carried out by the Nordic Network of Research on Mathematics Textbooks (Grevholm 2011).

11.8 Concluding Remarks

The teaching and assessing of WNA is a relatively large domain. It is not possible to cover all its aspects in a chapter. Therefore, it was necessary to select some aspects which may be addressed, as we have done in this chapter.

The choice of lenses used in this chapter was guided by several aspects: the main focus was formulated in the Discussion Document (this volume, [Appendix 2](#)) and represents the agreement of all the IPC members. The second strong influence was the development of the debates in Theme 4 sessions at the ICMI Study 23 Conference in Macao, the richness of which is documented in the survey of contributions at the beginning of this chapter. The third was the decision of the team of authors to develop ideas that emerged from the lesson that they observed in Macao as part of the conference. The purpose of using the lesson to contextualise the discussion in this chapter on aspects of teaching and assessing WNA was not to critique any particular approach nor use of resource of the lesson, but rather to show how the lesson may be interpreted using various theoretical and methodical frameworks.

References

- Bartolini Bussi, M. G., & Sun, X. (2015). Learning from the world: The teaching and learning of whole numbers arithmetic in the ICMI study 23. In Copirelem (Ed.), *Actes du 42e Colloque International des formateurs de mathématiques chargés de la formation des maîtres* (pp. 39–51). Besançon: ARPEME.
- Bartolini Bussi, M. G., Sun, X., & Ramploud, A. (2013). A dialogue between cultures about task design for primary school. In C. Margolinas (Ed.), *Task design in mathematics education. Proceedings of ICMI study 22* (pp. 549–558). UK: Oxford. Retrieved February 10, from <https://hal.archives-ouvertes.fr/hal-00834054v3>.
- Black, P. (2014). Assessment and the aims of the curriculum: An explorer's journey. *Prospects*, 44(4), 487–501.
- Bobis, J., Clarke, B., Clarke, D., Thomas, G., Wright, R., Young-Loveridge, J., & Gould, P. (2005). Supporting teachers in the development of young Children's mathematical thinking: Three large scale cases. *Mathematics Education Research Journal*, 16(3), 27–57.
- Bowden, J., & Marton, F. (1998). *The university of learning*. London: Kogan Page.
- Brousseau, G. (1997). *Theory of didactical situations in mathematics 1970–1990* (F. M. Cooper, N. Balacheff, R. Sutherland & V. Warfield, Trans.). Dordrecht: Kluwer Academic Publishers.
- Brousseau, G., & Sarrazy, B. (2002). *Glossaire de quelques concepts de la théorie des situations didactiques en mathématiques* (V. Warfield, Trans.). Bordeaux: DAEST, Université Bordeaux 2.
- Bruner, J. S. (1960). *The process of education*. Cambridge, MA: Harvard University Press.
- Cai, J. (2004). Developing algebraic thinking in the earlier grades: A case study of the Chinese elementary school curriculum. *The Mathematics Educator*, 8(1), 107–130.
- Clarke, D., Cheeseman, J., Gervasoni, A., Gronn, D., Horne, M., McDonough, A., Montgomery, P., Roche, A., Sullivan, P., Clarke, B., & Rowley, G. (2002). *Early numeracy research project final report*. Melbourne: Australian Catholic University.
- Clements, M. A., & Ellerton, N. (1995). Assessing the effectiveness of pencil-and-paper tests for school mathematics. In B. Atweh & S. Flavel (Eds.), *Galtha: Proceedings of the 18th annual conference of the Mathematics Education Research Group of Australasia* (pp. 184–188). Darwin: Northern Territory University.
- Freeman, D., & Porter, A. (1989). Do textbooks dictate the content of mathematics instruction in elementary schools? *American Educational Research Journal*, 26(3), 403–421.
- Gearhart, M., & Saxe, G. B. (2005). When teachers know what students know. *Theory Into Practice*, 43(4), 304–313.
- Gervasoni, A., Parish, L., Hadden, T., Turkenburg, K., Bevan, K., Livesey, C., & Crosswell, M. (2011). Insights about children's understanding of 2-digit and 3-digit numbers. In J. Clark,

- B. Kissane, J. Mousley, T. Spencer, & S. Thornton (Eds.), *Mathematics: Traditions and [new] practices. Proceedings of the 23rd biennial conference of the Australian Association of Mathematics Teachers and the 34th annual conference of the Mathematics Education Research Group of Australasia* (Vol. 1, pp. 315–323). Alice Springs: MERGA/AAMT.
- Gervasoni, A., & Sullivan, P. (2007). Assessing and teaching children who have difficulty learning arithmetic. *Educational & Child Psychology*, 24(2), 40–53.
- Grevholm, B. (2011). Network for research on mathematics textbooks in the Nordic countries. *Nordic Studies in Mathematics Education*, 16(4), 91–102.
- Haggarty, L., & Pepin, B. (2002). An investigation of mathematics textbooks in England, France and Germany: Some challenges for England. *Research in Mathematics Education*, 4(1), 127–144.
- Huang, R., & Li, Y. (2017). *Teaching and learning mathematics through variation. Confucian heritage meets Western theories*. Rotterdam: Sense Publishers.
- Kullberg, A. (2010). *What is taught and what is learned. Professional insights gained and shared by teachers of mathematics*. Göteborg studies in Educational sciences no 293. PhD thesis, Acta Universitatis Gothoburgensis, Göteborg.
- Lo, M. L., Pong, W. Y., & Chik, P. P. M. (Eds.). (2005). *For each and everyone: Catering for individual differences through learning studies*. Hong Kong: Hong Kong University Press.
- Marton, F., Tsui, A. B. M., Cjik, P. P. N., Ko, P. Y., & Lo, M. L. (2004). *Classroom discourse and the space of learning*. Mahwah: Lawrence Erlbaum Associates.
- Mitchell, A., & Horne, M. (2011). Listening to children's explanations of fraction pair tasks: When more than an answer and an initial explanation are needed. In J. Clark, B. Kissane, J. Mousley, T. Spencer, & S. Thornton (Eds.), *Mathematics: Traditions and [new] practices. Proceedings of the 23rd biennial conference of the Australian Association of Mathematics Teachers and the 34th annual conference of the Mathematics Education Research Group of Australasia* (Vol. 1, pp. 515–522). Alice Springs: MERGA/AAMT.
- Murata, A., & Fuson, K. (2006). Teaching as assisting individual constructive paths within an interdependent class learning zone: Japanese first graders learning to add using 10. *Journal for Research in Mathematics Education*, 37(5), 421–456.
- Reys, B. J., Reys, R. E., & Chávez, O. (2004). Why mathematics textbooks matter. *Educational Leadership*, 61(5), 61–66.
- Robitaille, D. F., & Travers, K. J. (1992). International studies of achievement in mathematics. In D. A. Grouws (Ed.), *Handbook of research on mathematics teaching and learning* (pp. 687–709). New York/Reston: Macmillan/National Council of Teachers of Mathematics.
- Runesson, U. (2005). Beyond discourse and interaction. Variation: A critical aspect for teaching and learning mathematics. *Cambridge Journal of Education*, 35(1), 69–87.
- Schmidt, W., McKnight, C., & Raizen, S. (1997). *A splintered vision: An investigation of U.S. science and mathematics education*. Boston: Kluwer Academic Publishers.
- Schoenfeld, A. H. (2014). What makes for powerful classrooms, and how can we support teachers in creating them? A story of research and practice, productively intertwined. *Educational Researcher*, 43(8), 404–412.
- Selter, C. (1998). Building on children's mathematics: A teaching experiment in grade three. *Educational Studies in Mathematics*, 36(1), 1–27.
- Shield, M., & Dole, S. (2013). Assessing the potential of mathematics textbooks to promote deep learning. *Educational Studies in Mathematics*, 82(2), 183–199.
- Sowder, J., Armstrong, B., Lamon, S., Simon, M., Sowder, L., & Thompson, A. (1998). Educating teachers to teach multiplicative structures in the middle grades. *Journal of Mathematics Teacher Education*, 1(2), 127–155.
- Steffe, L., Cobb, P., & von Glasersfeld, E. (1988). *Construction of arithmetical meanings and strategies*. New York: Springer-Verlag.
- Sullivan, P., Askew, M., Cheeseman, J., Clarke, D., Mornane, A., Roche, A., & Walker, N. (2015). Supporting teachers in structuring mathematics lessons involving challenging tasks. *Journal of Mathematics Teacher Education*, 18(2), 123–140.

- Sun, X. (2011a). An insider's perspective: "variation problems" and their cultural grounds in Chinese curriculum practice. *Journal of Mathematical Education*, 4(1), 101–114.
- Sun, X. (2011b). "Variation problems" and their roles in the topic of fraction division in Chinese mathematics textbook examples. *Educational Studies in Mathematics*, 76(1), 65–85.
- Sun, X. (2016). *Spiral variation: A hidden theory to interpret the logic to design mathematics curriculum and instruction in Mainland China (in Chinese)*. Singapore: World Scientific Publishing Company.
- Sun, X., Neto, T. B., & Ordóñez, L. E. (2013). Different features of task design associated with goals and pedagogies in Chinese and Portuguese textbooks: The case of addition and subtraction. In C. Margolinas (Ed.), *Task design in mathematics education. Proceedings of ICMI study 22* (pp. 409–418). Oxford. Retrieved February 10, from <https://hal.archives-ouvertes.fr/hal-00834054v3>.
- Tomroos, J. (2005). Mathematics textbooks, opportunity to learn and student achievement. *Studies in Educational Evaluation*, 31(4), 315–327.
- van den Heuvel-Panhuizen, M., & Becker, J. (2003). Towards a didactical model for assessment design in mathematics education. In A. J. Bishop, M. A. Clements, C. Keitel, J. Kilpatrick, & F. K. S. Leung (Eds.), *Second international handbook of mathematics education* (pp. 689–716). Dordrecht: Kluwer Academic Publishers.
- van den Heuvel-Panhuizen, M., & Drijvers, P. (2014). Realistic mathematics education. In S. Lerman (Ed.), *Encyclopedia of mathematics education* (pp. 521–525). Dordrecht/Heidelberg/New York/London: Springer.
- van Zanten, M., & van den Heuvel-Panhuizen, M. (2014). Freedom of design: The multiple faces of subtraction in Dutch primary school textbooks. In Y. Li & G. Lappan (Eds.), *Mathematics curriculum in school education, advances in mathematics education* (pp. 231–259). Dordrecht/Heidelberg/New York/London: Springer.
- Veilande, I. (2014). Contemporary study of 5th grade textbooks: Tasks on whole numbers and their compliance with mathematics Olympiad content. In K. Jones, C. Bokhove, G. Howson, & L. Fan (Eds.), *Proceedings of the International Conference on Mathematics Textbook Research and Development 2014 ICMT-2014* (pp. 477–482). Southampton: Southampton Education School, University of Southampton.
- Veldhuis, M., & van den Heuvel-Panhuizen, M. (2014). Exploring the feasibility and effectiveness of assessment techniques to improve student learning in primary mathematics education. In C. Nicol, S. Oesterle, P. Liljedahl, & D. Allan (Eds.), *Proceedings of the joint meeting of PME 38 and PME-NA 36* (Vol. 5, pp. 329–336). Vancouver: PME.
- Veldhuis, M., & van den Heuvel-Panhuizen, M. (2015). *Supporting primary school teachers' assessment practice in mathematics: Effects on students' learning*. <https://www.ris.uu.nl/ws/files/11827943/Veldhuis.pdf>. Manuscript submitted for publication.
- Vygotsky, L. S. (1980). *Mind in society*. Cambridge, MA: MIT Press.
- Wang, T., Cai, J., & Hwang, S. (2015). Achieving coherence in the mathematics classroom: Toward a framework for examining instructional coherence. In L. Fang, N. Y. Wong, J. Cai, & S. Li (Eds.), *How Chinese teach mathematics. Perspectives from insiders* (pp. 111–148). Singapore: World Scientific.
- Watson, A., & Mason, J. (2005). *Mathematics as a constructive activity: Learners generating examples*. Mahwah: Lawrence Erlbaum Associates.
- Watson, A., & Mason, J. (2006a). Seeing an exercise as a single mathematical object: Using variation to structure sense-making. *Mathematical Thinking and Learning*, 8(2), 91–111.
- Watson, A., & Mason, J. (2006b). Variation and mathematical structure. *Mathematics Teaching*, 194, 3–5.
- Wright, R., Martland, J., & Stafford, A. (2000). *Early numeracy: Assessment for teaching and intervention*. London: Paul Chapman Publishing.
- Xin, Y. P. (2007). Word problem solving tasks in textbooks and their relation to student performance. *Journal of Educational Research*, 100(6), 347–359.
- Zazkis, R., & Leikin, R. (2007). Generating examples: From pedagogical tool to a research tool. *For the Learning of Mathematics*, 27(2), 15–21.

Cited papers from Sun, X., Kaur, B., & Novotna, J. (Eds.). (2015). Conference proceedings of the ICMI study 23: Primary mathematics study on whole numbers. Retrieved February 10, 2016, from www.umac.mo/fed/ICMI23/doc/Proceedings_ICMI_STUDY_23_final.pdf

- Alafaleq, M., Mailizar, L., Wang, Y., & Fan, L. (2015). How equality and inequality of whole numbers are introduced in China, Indonesia and Saudi Arabia primary mathematics textbooks (pp. 392–398).
- Askew, M., (2015). Seeing through place value: An example of connectionist teaching (pp. 399–406).
- Barry, A., Novotná, J., & Sarrazy, B. (2015). Experience and didactical knowledge: The case of didactical variability in solving problems (pp. 407–414).
- Bartolini Bussi, M.G. (2015). The number line: A “western” teaching aid (pp. 298–306).
- Brombacher, A. (2015). National intervention research activity for early grade mathematics in Jordan (pp. 415–422).
- Butterworth, B. (2015). Low numeracy: From brain to education (pp. 21–33).
- Cao, Y., Li, X. & Zuo, H. (2015). Characteristics of multiplication teaching of whole numbers in China: The application of the nine times table (pp. 423–430).
- Chambris, C. (2015). Mathematical foundations for place value throughout one century of teaching in France (pp. 52–59).
- Changsri, N. (2015). First grade students’ mathematical ideas of addition in the context of lesson study and open approach (pp. 60–67).
- Cooper, J. (2015). Combining mathematical and educational perspectives in professional development (pp. 68–75).
- Ekdahl, A. L., & Runesson, U. (2015). Teachers’ responses to incorrect answers on missing number problems in South Africa (pp. 431–439).
- Gervasoni, A., & Parish, L. (2015). Insights and implications about the whole number knowledge of grade 1 to grade 4 children (pp. 440–447).
- Inprasitha, M. (2015). An open approach incorporating lesson study: An innovation for teaching whole number arithmetic (pp. 315–322).
- Kaur, B. (2015). The model method: A tool for representing and visualising relationships (pp. 448–455).
- Lin, P.-J. (2015). Teaching the structure of standard algorithm of multiplication with 2-digit multipliers via conjecturing (pp. 456–463).
- Ni, Y. (2015). How the Chinese methods produce arithmetic proficiency in children (pp. 339–345).
- Pearn, C. (2015). Same year, same school, same curriculum: Different mathematics results (pp. 464–471).
- Peter-Koop, A., Kollhoff, S., Gervasoni, A., & Parish, L. (2015). Comparing the development of Australian and German children’s whole number knowledge (pp. 346–353).
- Sensevy, G., Quilio, S., & Mercier, A. (2015). Arithmetic and comprehension at primary school (pp. 472–479).
- Siu, M-K. (2015). Pedagogical lessons from *Tongwen Suanzhi*: Transmission of *Bisuan* (Written calculation) in China (pp. 132–139).
- Wong, I. N., Jiang, C., Cheung, K.C., & Sun, X. (2015). Primary mathematics education in Macao: Fifteen years of experiences after 1999 handover from Portugal to Mainland China (pp. 480–487).
- Yang, D.-C. (2015). Performance of fourth graders in judging reasonableness of computational results for whole numbers (pp. 268–275).

- Zhang, Q-P., Cheung, K-C., & Cheung, K-F (2015). An analysis of two-digit numbers subtraction in Hong Kong primary mathematics textbooks (pp. 488–495).
- Zhao, X., van den Heuvel-Panhuizen, M., & Veldhuis, M. (2015). Classroom assessment techniques to assess Chinese students' sense of division (pp. 496–503).

Open Access This chapter is licensed under the terms of the Creative Commons Attribution 4.0 International License (<http://creativecommons.org/licenses/by/4.0/>), which permits use, sharing, adaptation, distribution and reproduction in any medium or format, as long as you give appropriate credit to the original author(s) and the source, provide a link to the Creative Commons license and indicate if changes were made.

The images or other third party material in this chapter are included in the chapter's Creative Commons license, unless indicated otherwise in a credit line to the material. If material is not included in the chapter's Creative Commons license and your intended use is not permitted by statutory regulation or exceeds the permitted use, you will need to obtain permission directly from the copyright holder.



Chapter 12

How to Teach and Assess Whole Number Arithmetic: A Commentary on Chapter 11



Claire Margolinas 

12.1 Preliminary Considerations About Teaching and Assessing

Teachers are accountable for classroom interactions and pupils' work assessment. However, those visible actions (for instance, during the lesson observed by working group 4 participants in Macao) are only a part of teachers' work, and include also:

- *Planning* not only a single lesson but also a sequence of lessons and more generally thinking about and designing the entire mathematical theme (for instance, WNA as a whole). This usually depends on use of resources that are selected by the teacher.
- *Selecting* the physical objects to be used during the lesson (or the sequence of lessons), the textbook which can be used by the pupils and/or by the teacher as a source of inspiration, the tasks that might be designed by others and are available (by sharing with colleagues, by browsing the Internet, etc.), the items for the assessment, etc.

These aspects of teaching require teacher knowledge, which is not easily observed, since it is accessible only by means of what the teacher might say about her activity, which is always a reconstruction on her part, and what the teacher is doing in the classroom, which is subject to diverse interpretations.

Various aspects of teacher knowledge have been considered within different frameworks that all take into account *pedagogical content knowledge* (Shulman 1986). This model has been refined by Deborah Ball and her colleagues (Ball et al. 2008), who have examined the impact *mathematical knowledge for teaching* on the quality of instruction (Hill et al. 2008). It is thus my purpose to highlight some

C. Margolinas (✉)

Laboratoire ACTé, Université Clermont-Auvergne, Clermont-Ferrand, France
e-mail: claire.margolinas@uca.fr

© The Author(s) 2018

M.G. Bartolini Bussi, X.H. Sun (eds.), *Building the Foundation: Whole Numbers in the Primary Grades*, New ICMI Study Series,
https://doi.org/10.1007/978-3-319-63555-2_12

287

aspects of whole number arithmetic knowledge for teaching which seem important to promote interest-dense situations (Bikner-Ahsbals et al. 2014) and thus the development of pupils' metacognitive strategies.

12.2 Whole Number Arithmetic and Mathematical Knowledge for Teaching

Chapter 11 and working group 4 of the conference refer to 'teaching and assessing whole number arithmetic'; this formulation leads to consider WNA as a homogeneous domain. However, some very different aspects have been investigated in the conference papers:

- Understanding of numbers
- Place value and written numbers
- Understanding of operations
- Written operations (standard and non-standard)
- Memorisation of numerical facts: additive or multiplicative

In the book, the main topic has been the one chosen for the observed lesson: understanding of addition with carrying.

However, making coherent choices about WNA teaching requires organised knowledge of WNA (Askew 2015) and specific knowledge of concepts (see Barry et al. 2015 for a study about additive problems):

- Which sub-matters are related?
- How these sub-matters are linked together?
- What are the vital choices for teaching numbers?

In order to approach those questions related to the teaching and assessing of WNA, I will take three examples and then return to the Macao lesson.

12.3 Memorising Numerical Facts

During early primary school, pupils are engaged in various memorisation activities: they memorise nursery rhymes and poems, the number name file, the days of the week, the name of the months, the names of their friends, etc. Some years later, they will memorise a lot of facts and rules: grammatical, historical, mathematical rules and facts, etc.

What specific knowledge do teachers need in order to help pupils to memorise numerical facts? Is this different from the memorisation of nursery rhymes? What about grammatical rules? Are all numerical facts alike in terms of memorisation?

Let's begin with the first numerical memorisation: oral number names. This sequence of words share some properties with all songs and rhymes: some parts are made from words without links (one, two, like Humpty Dumpty); some parts are similar (twenty-one is similar to thirty-one, like a chorus) and you have to say it in the right order. However, number names are special: because of their use for counting, in particular, the words have to be clearly separated (one/two/three and not onetwothree), and the exact words and order of the words are crucial. If the oral number file is a base-ten language (a lot of languages across the world are in base twenty, also known as vigesimal¹), you have thus at least ten different terms to memorise. Those terms are not different from any other list of terms (days of the week, song, etc.). The following names depend on the language you use (see this volume, Chap. 3). If you are very lucky, you may live in a country where the oral numeration is regular: ten-one, ten-two, etc. If you are not so lucky, you will have to memorise other terms, for instance, eleven and twelve in English (and up to the name for 16 in French, etc.). The rest of the list will have some regularity and irregularity, thirteen instead of third-ten, for instance, or a vigesimal system at some point (for instance, from 60 up to 99 in France). Teachers have to be aware of nuances of language in order to understand when they have to treat the number name file exactly like a song and when they might help the children understand how it is built. *This is clearly mathematical knowledge for teaching: it is not mathematical common knowledge.* For instance, a majority of persons in France are not aware of a base twenty (it is different in Belgium, Canada or Switzerland), but for teachers it is vital knowledge to understand that it is quite strange to say *soixante-dix* (sixty-ten), but if you do, it is normal to proceed and say *soixante-et-onze* (sixty-and-eleven).

If we now take the memorisation of numerical facts about addition and subtraction, it is first to be noted that it is not obvious to know when you really enter 'addition'. For instance, you have to teach very early that if you say six after five in the oral number file, in consequence if you have five objects and another one, you will have six in all. This will be related later to $5 + 1 = 6$. However, it means that those additive facts (+1) are learned in a totally different way as, for instance, $5 + 3 = 8$.

If we proceed on our reflection about the memorisation of additive facts, there are different ways to give the answer promptly (see Cao et al. 2015 about memorisation of multiplication table). The first is to memorise every additive fact. For numbers less than ten, you have 10×10 facts to memorise, but we have already stated that perhaps you may not have to memorise +1 as an additive fact, which takes off ten results to memorise. If you know $6 + 1 = 7$, do you have to learn that $1 + 6 = 7$, or do you have to know that you can exchange the numbers in addition (commutativity)? There is a balance to be found between the memorisation of facts and the memorisation of properties (which is the very first element of algebraic thinking; see Wong et al. 2015 for other algebraic problems).

If we return to $6 + 7$, you may have memorised the answer among the 90 or 45 facts that remain in your list, or you can think that 'six and four, ten and three: thirteen'. In order to obtain 13 very rapidly, you should memorise the ten comple-

¹<https://en.wikipedia.org/wiki/Vigesimal>

ments (five facts only if you consider commutativity) and the procedure to count with ten or multiples of ten. There is, thus, also a balance to be found between the memorisation of facts and the memorisation of procedure.

Furthermore, the choice of procedures is crucial. For the same addition, if you have learnt to calculate using 5 as a step, you will think ‘five and five and one and two: thirteen’ and not ‘six and four and ten and three’.

Those mathematics reflections have a big impact on the teaching and assessing of additive facts. For instance, if you want to induce 5 as a step, you will teach all the decomposition of numbers using 5 as a step from the beginning of the teaching of number: 6 will be considered as 5 and 1, 7 as 5 and 2, etc., and those relationships to 5 will be memorised. To assess the memorisation of additive results will be considered with those results and subsequent procedures in mind. For instance, it would be considered as a really basic task to give the answer to $12 + 13$, but more difficult to give the answer to $16 + 14$ and even more $17 + 18$. On the other hand, if you have memorised additive results using 10 as a step, $16 + 14$ should be the easiest.

The role of researchers in mathematics education may have a great impact on teaching and assessing if they help teachers to understand how special mathematics considerations will impact their decisions when they plan their teaching and select their materials and also highlight the different aspects of ‘memorisation’.

12.4 Writing Numbers and Numerical Sentences

Some aspects of mathematical writing are specific, and some are shared with all writing language experiences (see Sensevy et al. 2015 for a design which is based on writing mathematics). The aspect which is present in both cases is the possibility that writing offers to avoid painstaking memorisation of facts. Writing is thus always in concurrence with oral memorisation. Another common aspect of writing is the possibility to communicate to others with a spatial or temporal gap. Yet another is the bureaucratic function of writing: when you write, you can organise the objects, for instance, in columns and lines, in ways you cannot reproduce orally (Goody 1986). What is totally different is the lack of connection between sounds and writing: 216 is not read two-one-six, etc. Furthermore, 21 is read twenty-one but when you read 216 you do not hear twenty-one (it is not easy to understand that there are 21 somethings in this number: 21 tens). Another notable disparity is that between the quite universal understanding of written numbers and that of mathematical writing in general. Thus the use of writing in mathematics should be a specific part of teaching mathematics (and not only written standard algorithms; see Zhao et al. 2015).

For instance, suppose that you want to associate eggs with egg cups with a temporal gap (see Alafaleq et al. 2015 for equality problems in textbooks). You have the eggs one day and the egg cups the day after. It is difficult to memorise the number of eggs, and you might use writing for this task. When you implement this situation for pupils (5–6 years old), the use of numerical writing is required in this situation.

Depending on the number of eggs and pupils' knowledge of writing numbers with digits, they may struggle to find a suitable way to use writing.

Some pupils will try to draw eggs, using the right colour and the right shape, but not the right quantity. They will realise that their writing does not give any information when confronted with the egg cups. A successful procedure might be to use the spatial organisation of the eggs and try to draw a 'map' with the places of the eggs, drawing for instance round shapes. Another procedure is to draw little straight lines: one for each egg. Teachers should consider this procedure as a very interesting attempt at symbolisation and thus encourage this behaviour and not only consider writing with digits. There are different ways to write quantities, and the efficacy of writing depends on the situations you are dealing: in particular situations, even an adult might write HHH HHH HHH in order to keep a record of 15 objects.

It is not enough to acknowledge that writing mathematics is an important part of whole number arithmetic. How this process is approached will vary according to the teacher's interpretation, whether they see writing as a fixed set of rules or as a way to think mathematically. I will illustrate this with an example (Laparra and Margolinas 2009). During a session observed in class 1, pupils were asked to solve the following problem 'There are 12 squares in a box. There are red and blue squares. There are 5 red squares. How many blue squares?' Pupils had some difficulties to solve this problem: they had not studied subtraction previously, and it was the first time they had to solve a word problem. At some point during the lesson, when all pupils were convinced that 7 blue squares was the solution, the teacher asked them to write or draw something in order to explain their solutions. Hamdi (Fig. 12.1) had drawn 12 squares and crossed 5 squares: there are 7 non-crossed squares. The representation of the problem is particularly accurate.

If you read the mathematical sentence, $12 + 5 = 7$, you might think that Hamdi has made a big error (that is what the teacher thought), but it is highly improbable that Hamdi thought twelve and five are seven. In writing this wrong sentence, Hamdi demonstrates his current knowledge of written operation. He has written the numbers in the order of the given problem (12, 5, 7) and also in the order he has made use of those numbers in the schema, which is wrong for mathematical sentences but right for linguistic sentences, although the sentence is mathematically well formed. Hamdi certainly knows that the result of calculation is normally after the equality sign, but he doesn't know how to combine the only signs he had already learned (+ and =) in order to explain his reasoning.

On the other hand, if you consider Floriane's production (Fig. 12.2), it is difficult to understand Floriane's solving procedure, but it is very interesting to discover a kind of prefiguration of an equation: $5 + x = 12$.

Fig. 12.1 Hamdi's representation of the squares problem

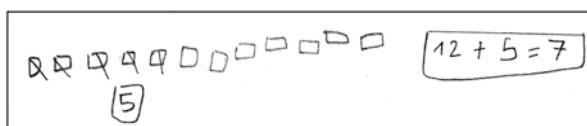

Fig. 12.2 Floriane's representation of the squares problem

Handwritten mathematical work showing a crossed-out equation and a new one:

$$\cancel{5 + 7 = 12}$$

$$5 + 7 = 12$$

Both productions have their own qualities, and they reveal the difficulty to assess the production of written mathematical sentences. Unfortunately, the teacher was only interested in the correctness of the written addition.

There is certainly an important need for collective work in mathematics education in order to convey coherent knowledge about writing numbers and numerical sentences, since this is crucial for teaching and asserting WNA in general, at all levels of teaching.

12.5 The Field of Additive Structures

The expression 'field of additive structures' is taken from Vergnaud (1983, p. 31), whose work is of paramount importance in order to understand together addition and subtraction (for Chinese tradition, see Sect. 11.4.1).

The first comment based on Vergnaud's work is about subtraction – comparison between quantities is only one meaning for subtraction:

The very first conception of subtraction for a young child is a "decrease" of some initial quantity [...]

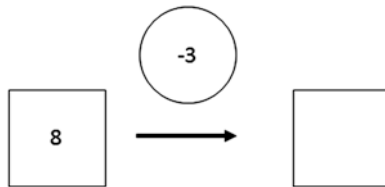

Example 1: John had 5 sweets, he eats 3 of them. How many sweets does he have now?

It is not straightforward, with such a conception in mind, to understand –subtraction as a relation of complements.

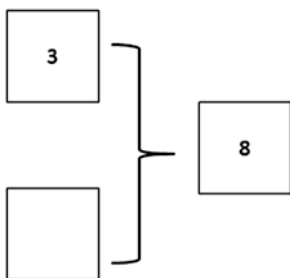

Example 2: There are 8 children around the table for Dorothy's birthday. 3 of them are girls. How many boys are there? (Vergnaud 1983, pp. 31–32)

In the following pages of the paper, Vergnaud enumerates and exemplifies the other conceptions of subtraction, as the inverse of an increase and as a difference relationship between states, between compared quantities and between transformations, and he concludes with: 'One can easily imagine the difficulties that children may meet in extending the meaning of subtraction from their primitive conception of a 'decrease' to all these different cases' (p. 32). Vergnaud has shown that pupils are able to solve the first problems from a young age, but the more difficult ones only at the end of primary school (even if the calculation, $8-3$, remains the same). The same kind of differences of conception exists also for addition, both operations being regrouped in the additive structure field.

Those distinctions are essential for teacher mathematical knowledge, since they have to be aware of the nature of the problems which are proposed, in order to teach or assess addition and subtraction. The predominance of comparison has to be questioned (Sect. 11.4.1, Kaur 2015, Zhang et al. 2015), in particular in textbooks, because it will impact implicitly on teacher's conception (Sect. 11.7).

12.6 The Macao Lesson: A Commentary

In this last part of this paper, I will give an overview of the points of the Macao lesson on addition, using the different aspects I have introduced earlier.

My first remark is about the subject matter of the lesson: it is well known that addition, even with carrying, is very easy, compared with subtraction (see Pearn 2015), and I would have been very interested to know how the skilful teachers of this school would have taught this challenging subject matter.² Even if I understand that the choice was not due to the working group, it is important to reflect on the most favourable environment of a scientific discussion about teaching and assessing WNA.

²Another group of participants (from other working groups) actually observed a lesson on subtraction in another school.

However, the lesson is very interesting in itself, and it is in a certain sense a model of mastery of a kind of lesson which can be observed also in other countries:

- The lesson begins with the oral recollection of numerical facts (number combination for ten), during which students are encouraged to give answers very rapidly.
- The teacher has introduced a material (candies and boxes of candies), pupils are mostly working with the material, they express their ideas orally, and they write with the scaffolding of the teacher.
- Different problems of addition of increasing difficulties are introduced with both representation of material and mathematical sentences ($40 + 3$; $25 + 2$; $25 + 20$) before the core topic of the lesson, which is to study an addition with carrying ($24 + 9$).
- The teacher is aware of a variety of possible answers for this problem, she has determined three procedures, and those procedures are represented by numerical sentences which are written in advance and ready to show to the pupils.
- The ‘making-ten’ strategy is clearly emphasised at the end of the lesson during the ‘lesson summary’.

The calculations (Stage 1) in the oral phase represent nearly all the combinations for ten (only $0 + 10$ is missing); thus, the answer is always ten. The first five questions are given in order (one number in the addition increases by one at every step). Thus, this first part of the lesson can be considered as a systematic presentation of the combinations for ten, but not as an episode of working on fluency. It is interesting to note that, in my experience, this is very common (in France, at least): oral fluency of number facts is very frequently underestimated. More generally, orality (Goody 1977; Ong 2002), which has its own mode of knowing and organising facts, is not considered as really important. In this lesson, the very fact that the questions were presented as written sentences and organised in two columns, more (first column) or less (second column) organised by increasing one number, is somehow ‘transparent’ (Margolinas and Laparra 2011). There is frequently little awareness on the part of the teachers that oral mathematical facts and written ones are very different. For instance, in the Macao lesson, there was clearly a choice to be made: working on oral facts (and in this case giving questions orally and choosing questions with results not always ten) or working on organising facts about combinations for ten using writing. For some reason, oral calculation is not seriously considered, even if rapid oral calculation is still useful, whereas written calculation cannot compete with the use of a calculator: you will find more easily your phone in your pocket than paper and pencil.

The use of material (Stages 2–3) is also interesting because it might be found in different countries around the world, where base-ten material is generally used. The material used here has a property which is not always found: there is a ten-place grid composed of five and five places and you can take out or put elements in this grid. In some other classes, groups of ten cannot be decomposed: you thus have units and tens and if you have ten units you have to exchange those for a ten. There are

discussions, around the world, on the differences between the two conceptions of place value: a ten is the first group in base-ten numeration (10^1) or a ten is a unit in itself. Choosing this material leads clearly to the first conception, but you can manipulate for at least two very different reasons. The first is purely material: if, for $24 + 9$, a pupil shows two complete ten grids, one grid with four candies and one grid with nine candies, the teacher might say: ‘you know that you are not allow to do that: you must complete the grid before taking another one’. In this case, pupils are only manipulating objects with a very loose relationship to base-ten operations, which is different if the teacher says: ‘In order to organise the candies in base ten, you always have to make a group of ten when it’s possible. Can you make another group of ten with your candies?’. The different solutions, which have been shown by the teacher in Stages 2 and 3, were clearly aimed at the second version, because they demonstrate different ways to regroup the candies in tens, using a schematisation. However, we do not know how to consider the relationship between boxes, candies and written numbers on the one hand and the role played by oral numeration on the other. This is particularly important when oral numeration is not congruent to written numeration (which is the case in the major European languages: you say twenty and not two-tens, where in most Asian languages oral numeration is regular). For instance, you can count ten, twenty, twenty-three (see figure in Stage 3) and write 23 as the cultural way to write twenty-three, or you can say two tens and directly write 2 in the left place which is the place value for tens and three units and write 3 in the right place (place value for units). With the same material, both decisions are possible, which are very different from a teaching point of view.

The selection of the introductory additions ($40 + 3$; $25 + 2$; $25 + 20$) highlights the teacher’s choices and the mathematical knowledge of the team: in the first, a number with only tens and a number with only units are dealt with independently, in the second, you have to combine the units of the second number with those of the first and, in the last one, this is the same but with tens. Thus, the environment of the last problem, which is the core of the lesson ($24 + 9$), is not only material; it is also made of mathematical knowledge, which has been carefully introduced by the teacher. In focusing on more general considerations (existence of material, familiarity with the material, etc.), those calculations are components of the *milieu* (Brousseau 1997; Brousseau et al. 2014), which is never only material.

The teacher has determined in advance the possible procedures for $24 + 9$. What is striking is that she has written everything in advance (Sect. 11.6). In this case, mathematical writing cannot emerge as a way to understand a solution, and there is no place for false solutions (see Ekdahl and Runesson 2015). Pupils might know the answer, either because other pupils have said it was 33 or because they have counted the candies one by one. Therefore, they might have the mathematical sentence right ($24 + 9 = 33$), but not the right base-ten properties. Wrong solutions might trigger the occasion to recall what base-ten is about: when you have ten, you regroup (which is true for units but will be true also for tens and so on). For example, with 4 and 9 you can make a ten, either with $4 + 6$ (and leave 3) or with $9 + 1$ (and leave 3), or you can know that $4 + 9 = 13$, which is a ten and 3 units. Thus, it is an opportunity for the teacher to state the reasons for the three different solutions. This demonstrates

the downside to having everything written in advance: the reasoning that underpins these solutions might remain unexplained.

The last remark relates to the conclusive part of the lesson. Task designers (Watson and Ohtani 2015) usually carefully describe the ‘active’ part of the task: the problem to solve and the environment of the problem. However, they usually avoid to enter into considerations about what you might tell pupils regarding what they have learned and what they have to memorise. If we use Brousseau’s words (Sect. 11.5), task designers are usually more concerned by the devolution process than by the institutionalisation process (Brousseau 1992; Margolinas 2005; Margolinas and Laparra 2008). The conclusive part in the Macao lesson shows clearly what the teacher expects of the pupils in the future: to learn the ten complements and to learn how to use them. The whole lesson appears, at this moment, as a whole, for students and for the observers.

12.7 Some Concluding Comments

Chapter 11 and working group 4 have taken into consideration some important processes in teacher work. In an attempt to complement this work, I have focused on mathematical knowledge for teaching, in order to stress the need to consider our own conception of whole number arithmetic and the way it impacts our research and our analysis of teacher work.

If we take seriously the very interesting suggestion made in Sect. 11.3.2 to transform a closed question into an open one (Sullivan and Lilburn 2004), we have thus to consider not only the shift in role it implies, but also the mathematical knowledge which might be learned by pupil difficulties and the mathematical knowledge necessary for the teacher. The intent of the Macao lesson, as clearly revealed in the concluding part, was to teach the use of the ten complements in order to give the result of any addition with carrying, which is useful either for mental or written calculations. The purpose of the study of the open problem proposed is completely different: it is true that it involves pupils doing additions and reflecting upon addition as an operation (and even as a function, since it can be modelled using the linear function $y = 33 - x$). The challenge for researchers might also be to find better problems with the *same* purpose, which is a very different question: that is, to focus also on ‘daily routine’ (see Brombacher 2015).

In general, I think that we often underestimate teacher knowledge required not only for selecting challenging and dense tasks but also, within a determined task, for responding to the diverse needs of individuals (Sect. 11.3.3) and to assess this need (see Gervasoni and Parish 2015). It is certainly not a little challenge for mathematics education research to describe the knowledge at stake, even within the field of WNA and even if we take a single lesson (see Lin 2015 for a development about the algorithm for multiplication). This book is certainly a very important step in this direction.

References

- Ball, D. L., Thames, M. H., & Phelps, G. (2008). Content knowledge for teaching: What makes it special? *Journal of Teacher Education*, 59(5), 389–407.
- Bikner-Ahsbahs, A., Prediger, S., & Halverscheid, S. (2014). Introduction to the theory of Interest-Dense Situations (IDS). In A. Bikner-Ahsbahs & S. Prediger (Eds.), *Networking of theories as a research practice in mathematics education* (pp. 97–113). Dordrecht/Heidelberg/New York/London: Springer.
- Brousseau, G. (1992). Didactique: What can it do for the teacher. In R. Douady & A. Mercier (Eds.), *Research in Didactique of mathematics* (pp. 7–40). Grenoble: La Pensée sauvage.
- Brousseau, G. (1997). *Theory of didactical situations in mathematics*. Dordrecht: Kluwer Academic Publishers.
- Brousseau, G., Brousseau, N., & Warfield, V. (2014). *Teaching fractions through situations: A fundamental experiment*. Dordrecht/Heidelberg/New-York/London: Springer.
- Goody, J. (1977). *The domestication of the savage mind*. Cambridge: University Press.
- Goody, J. (1986). *The logic of writing and the organization of society*. Cambridge: Cambridge University Press.
- Hill, H. C., Blunk, M. L., Charalambous, C. Y., Lewis, J. M., Phelps, G., Sleep, L., & Ball, D. L. (2008). Mathematical knowledge for teaching and the mathematical quality of instruction: An exploratory study. *Cognition and Instruction*, 26(4), 460–511.
- Laparra, M., & Margolinas, C. (2009). Le schéma: un écrit de savoir? *Pratiques*, 143–144, 51–82. <https://hal.archives-ouvertes.fr/hal-00722211>.
- Margolinas, C. (2005). La dévolution et le travail du professeur. In P. Clanché, M.-H. Salin, & B. Sarrazy (Eds.), *Autour de la théorie des situations* (pp. 329–333). Grenoble: La Pensée sauvage.
- Margolinas, C., & Laparra, M. (2008). *Quand la dévolution prend le pas sur l'institutionnalisation. Des effets de la transparence des objets de savoir: Les didactiques et leur rapport à l'enseignement et à la formation*. <http://hal.archives-ouvertes.fr/hal-00779656>
- Margolinas, C., & Laparra, M. (2011). Des savoirs transparents dans le travail des professeurs à l'école primaire. In J.-Y. Rochex & J. Crinon (Eds.), *La construction des inégalités scolaires* (pp. 19–32). Rennes: Presses universitaires de Rennes.
- Ong, W. J. (2002). *Orality and literacy*. London/New York: Routledge.
- Shulman, L. S. (1986). Those who understand. Knowledge growth in teaching. *Educational Researcher*, 15(2), 4–14.
- Sullivan, P., & Lilburn, P. (2004). *Open-ended maths activities: Using "good" questions to enhance learning in mathematics*. Melbourne: Oxford University Press.
- Vergnaud, G. (1983). Cognitive and developmental psychology and research in mathematics education: Some theoretical and methodological issues. *For the Learning of Mathematics*, 3(2), 31–41.
- Watson, A., & Ohtani, M. (2015). *Task design in mathematics education*. Heidelberg: Springer.

Cited papers from Sun, X., Kaur, B., & Novotna, J. (Eds.). (2015). Conference proceedings of the ICMI study 23: Primary mathematics study on whole numbers. Retrieved February 10, 2016, from www.umac.mo/fed/ICMI23/doc/Proceedings_ICMI_STUDY_23_final.pdf

- Alafaleq, M., Mailizar, L., Wang, Y., & Fan, L. (2015). How equality and inequality of whole numbers are introduced in China, Indonesia and Saudi Arabia primary mathematics textbooks (pp. 392–398).
- Askew, M. (2015). Seeing through place value: An example of connectionist teaching (pp. 399–406).
- Barry, A., Novotná, J., & Sarrazay, B. (2015). Experience and didactical knowledge: The case of didactical variability in solving problems (pp. 407–414).
- Brombacher, A. (2015). National intervention research activity for early grade mathematics in Jordan (pp. 415–422).
- Cao, Y., Li, X., & Zuo, H. (2015). Characteristics of multiplication teaching of whole numbers in China: The application of the nine times table (pp. 423–430).
- Ekdahl, A.-L., & Runesson, U. (2015). Teachers' responses to incorrect answers on missing number problems in South Africa (pp. 431–439).
- Gervasoni, A., & Parish, L. (2015). Insights and implications about the whole number knowledge of grade 1 to grade 4 children (pp. 440–447).
- Kaur, B. (2015). The model method: A tool for representing and visualising relationships (pp. 448–455).
- Lin, P.-J. (2015). Teaching the structure of standard algorithm of multiplication with 2-digit multipliers via conjecturing (pp. 456–463).
- Pearn, C. (2015). Same year, same school, same curriculum: Different mathematics results (pp. 464–471).
- Sensevy, G., Quilio, S., & Mercier, A. (2015). Arithmetic and comprehension at primary school (pp. 472–479).
- Wong, I.N., Jiang, C., Cheung, K.-C., & Sun, X.H. (2015). Primary mathematics education in Macao: Fifteen years of experiences after 1999 handover from Portugal to mainland China (pp. 480–487).
- Zhang, Q.-P., Cheung, K.-C., & Cheung, K.-F. (2015). An analysis of two-digit numbers subtraction in Hong Kong primary mathematics textbooks (pp. 488–495).
- Zhao X., van den Heuvel-Panhuizen, M., & Veldhuis, M. (2015). Classroom assessment techniques to assess Chinese students' sense of division (pp. 496–503).

Open Access This chapter is licensed under the terms of the Creative Commons Attribution 4.0 International License (<http://creativecommons.org/licenses/by/4.0/>), which permits use, sharing, adaptation, distribution and reproduction in any medium or format, as long as you give appropriate credit to the original author(s) and the source, provide a link to the Creative Commons license and indicate if changes were made.

The images or other third party material in this chapter are included in the chapter's Creative Commons license, unless indicated otherwise in a credit line to the material. If material is not included in the chapter's Creative Commons license and your intended use is not permitted by statutory regulation or exceeds the permitted use, you will need to obtain permission directly from the copyright holder.



Chapter 13

Connecting Whole Number Arithmetic Foundations to Other Parts of Mathematics: Structure and Structuring Activity



Hamsa Venkat , Sybilla Beckmann 
Kerstin Larsson , Yan Ping Xin , Alessandro Ramploud ,
and Limin Chen 

13.1 Introduction

The focus of this chapter is on the use of structure and structuring activities as key means through which whole number arithmetic (WNA) can be connected to other areas of mathematics. As with the other chapters in this volume, several of the studies that we use to exemplify attention to structure and structuring in this chapter are drawn from contributions to ICMI Study 23: Primary Mathematics Study on Whole Numbers that was the key precursor to this volume. We begin this chapter with an

Electronic Supplementary Material The online version of this chapter (doi:[10.1007/978-3-319-63555-2_13](https://doi.org/10.1007/978-3-319-63555-2_13)) contains supplementary material.

The first two authors wrote the chapter with the collaboration of other working group members.

H. Venkat (✉)

University of the Witwatersrand, Johannesburg, South Africa

e-mail: Hamsa.Venkatakrishnan@wits.ac.za

S. Beckmann (✉)

University of Georgia, Athens, GA, USA

e-mail: sybilla@uga.edu

K. Larsson

Stockholm University, Stockholm, Sweden

Y.P. Xin

Purdue University, West Lafayette, IN, USA

A. Ramploud

Scuola Primaria Leopardi, Reggio Emilia, Italy

L. Chen

Shenyang Normal University, Shenyang, China

© The Author(s) 2018

M.G. Bartolini Bussi, X.H. Sun (eds.), *Building the Foundation: Whole Numbers in the Primary Grades*, New ICMI Study Series, https://doi.org/10.1007/978-3-319-63555-2_13

introductory preface of contributions to the working group focused on the connections between WNA and other parts of mathematics, and use this overview to explain why attention to structure and structuring came to figure as a key overarching theme for looking across these connections. In this preface, we also note the ways in which our focus in this chapter connects with the focus of broader discussions in the other working groups and in the panel presentations at ICMI Study 23, which are also taken up across a range of the chapters in this volume.

13.1.1 What Was Presented at the Conference: Overview

Several of the contributions to the theme focused on connections between WNA and other areas were centrally concerned with the ways in which structuring activity and structure figured in supporting these connections. These studies attend to structuring and structure at the levels of learning, teaching and teacher education, and curricula and were drawn from research studies undertaken across the Americas, Europe, Africa, Asia and Australia, including input from ICMI CANP observer Estela Vallejo, from Peru.

At the conference, the presentations were organised into five sessions: two on whole number arithmetic and early algebra; two on whole number arithmetic and multiplicative reasoning, at the learner level and at the teacher level; and one session on whole number arithmetic competence as it relates to language ability and teacher development.

13.1.1.1 Whole Number Arithmetic and Early Algebra

Two papers concerned ways to visually depict and organise relationships. Mellone and Ramploud (2015) analysed the ‘pictorial equation’, which is used in Russian and Chinese primary schools to teach additive relationships. They discussed the cultural transposition that is involved in using this tool with Italian students. The authors found increased visibility of structural and algebraic approaches to additive relationships. Xin (2015) reported on substantial improvements in the mathematics performance of U.S. children with learning difficulties when using an approach that models the grammar of additive and multiplicative situations. The approach draws attention to the algebraic structure of such situations.

Two papers concerned tasks about patterns. Eraky and Guberman (2015) found that 5th and 6th grade Israeli learners working with numerical patterns were better able to generalise than those working with visual-pictorial patterns. These authors emphasised the need to push for more complex structural generalisations and multiple stages of generalisation. Ferrara and Ng (2015) reported on 3rd grade Italian students working with a figural pattern task. Working from a framework of assemblage, in which learning is an output of agency distributed between body and mate-

rial, they explore arithmetic awareness within the development of algebraic thinking.

13.1.1.2 Whole Number Arithmetic and Multiplicative Reasoning

Looking at the learning level, Venenciano et al. (2015) reported on a study in Hawaii in which place value understandings were developed through ideas of measurement. They found that learners' initial attention to comparing quantities grew into an awareness of the need for intermediate regrouped units. Larsson and Pettersson (2015) investigated how Swedish learners solved mixed sets of additive and multiplicative covariation problems. They found that stronger performance was associated with inferring distance relationships from information about speed relationships, whereas weaker performance was associated with reliance on single procedures and attention to superficial contextual differences. Chen et al. (2015) investigated Chinese learners' performance on learning and assessment tasks about multiplication and division by rational numbers. The learning tasks were of three different types: computation, problem solving or problem posing. The findings point to performance on problem-posing tasks as important.

Moving to the teacher level, Beckmann et al. (2015) discussed their use of a quantitative definition of multiplication to help future middle grades teachers in the USA organise their thinking around topics including ratio and proportional relationships. Dole et al. (2015) reported on a curriculum analysis in Australia and the finding that teachers are often unaware of how many topics from the early grades through grade 9 offer opportunities for proportional reasoning. Venkat (2015) discussed research on a teacher education project in South Africa showing how representational approaches used with whole number scaling up can simultaneously support teachers' mathematical learning and their mathematics teaching.

13.1.1.3 Whole Number Arithmetic Competence: Language/Teacher Development

Zhang et al. (2015) presented the results of an investigation into how Chinese kindergarteners' language ability is related to their mathematical skills. They found that language ability was more strongly associated with informal mathematical skills (e.g. counting) than with more formal ones (e.g. addition and subtraction).

Baldin et al. (2015) shared data on an in-service teacher development model based on pedagogical content knowledge frameworks. The model was used in Brazil to strengthen teachers' knowledge and practice with whole number arithmetic.

13.1.2 The Discussion in the Working Group

The presentations and discussions in the working group sessions were lively, and the group developed a real sense of community and friendship while discussing the presentations and thinking together about next steps. A central focus of the discussions was on environments in which key ‘glueing’ ideas of mathematics related to WNA are featured. Across the papers and discussion sessions, these ideas encompassed multiplicative thinking and proportionality, measurement, generalising and mathematical models that attended to structure and generality. Central to some contributions, and implied or assumed in others, was the need to further develop teacher education in ways that promote understanding of connections and relations within and beyond WNA. The presentations and discussions emphasised the importance of creating representations such as actions, gestures, mental models and diagrams to construct mathematical relations.

In synthesising the presentations and discussions, the working group identified and developed crosscutting themes. A concept map was produced that organised the presentations into seven themes: justification; additive versus multiplicative thinking; structural relations; language; models, modelling and representations; general/specific; and teacher education. From these themes, the overarching theme of structure and structuring emerged as one that could organise and tie the presentations and discussions together into a coherent whole.

13.1.3 Connections to Other Working Groups, Panels and Plenary Presentations

The ubiquity of connections between mathematical topics and the overarching nature of mathematical processes makes it both difficult and unhelpful, in many ways, to compartmentalise discussions about mathematical thinking, learning and teaching into discrete categories. Thus, there are numerous connections between the ideas discussed in working group 5 and the other working groups, panels and plenary sessions at the conference. We note here a few that stand out as particularly pertinent to our focus.

On the surface, a tension is possible to discern relating to the timelines of introduction of attention to early algebra. In Ma’s plenary presentation (this volume, Chap. 18), she expressed concern over pushing algebra down into the early grades of elementary school. In contrast, a number of presentations in the working group focused on attending to algebraic structure in the context of early WNA. Ma pointed to the theoretical core of school mathematics as (1) the basic concept of a unit and (2) two basic quantitative relations (adding and multiplying). However, as some of the papers that we discuss in the body of this chapter make clear, several of the ‘early algebra’ approaches discussed in the presentations seem also to be in the service of developing the concept of a unit and an understanding of the structure of

arithmetic operations. Thus, the extent of the tension perhaps relates more to issues of what comes to be named as early algebra, rather than of its substance.

Taking a pattern-oriented route to focus on early algebra, Mulligan, in the panel on special needs (this volume, Chap. 16), reported on a long-term research project investigating the role of pattern and structure in mathematics learning. Findings included (1) an awareness of mathematical pattern and structure can be taught and (2) early school mathematics achievement is associated with children's level of this awareness. Mulligan concluded that mathematics curricula should promote structural thinking.

As with any issue concerning teaching and learning, connections between whole numbers and other topics will necessarily relate to teacher education. It is therefore no surprise that issues of teacher education arose repeatedly throughout the presentations and discussions of working group 5. The panel on teacher education (this volume, Chap. 17) connected to working group 5 in several ways. As one example, Kaur discussed the model method used in Singapore. This method relates directly to (1) the 'pictorial equation' approach discussed by Mellone and Ramploud (2015), (2) the measurement approach taken by Venenciano et al. (2015) and (3) one of the approaches to proportional relationships taken by Beckmann et al. (2015). Bass' plenary presentation (this volume, Chap. 19) also connected to this theme in highlighting the role of the number line and the idea that numbers can be viewed as an outcome of measurement activities.

We highlight one additional paper related to working group 5 because it indicates just how deep the connections are across mathematical ideas and how much everyone, even professional mathematicians, stand to learn about them. Cooper (2015), in his paper for working group 1, discussed how a mathematician – in his role as the instructor of a professional development course for teachers – gained a deeper understanding of division with remainder and its connection to topics beyond whole number arithmetic, including fractions and tests for divisibility.

13.1.4 The Structure of This Chapter

Connections between whole number arithmetic (WNA) and other parts of mathematics as a title suggest, at first glance, a focus on the need to, and ways in which to, build bridges between other content areas and WNA. This focus remains important in the face of ongoing evidence of frequently localised and highly fragmented and inflexible approaches to problem solving. This fragmentation has been described as an outcome of encounters with content in highly compartmentalised ways (Schoenfeld 1988). Given that WNA is, in mathematics curricula in most parts of the world that we have seen, the area in which induction into mathematics occurs, it is particularly important that this induction occurs in ways that allow for expansion into, and connections between, mathematical topics. In this chapter, we attend to this concern with a more general proposal about the ways in which the traditional contents of WNA instruction might be approached: attending, on the one hand, to

mathematical structures that begin in the context of WNA but transcend these boundaries and, on the other hand, to providing openings to teachers and to students to engage in structuring activity as a key mathematical practice that again can begin in the context of, and also transcend, WNA. In this chapter, we begin by using literature to describe what we mean by attending to structure and structuring activity. In the body of the chapter, we present and discuss examples of ways in which attention to structure and engagement with structuring can support moves beyond WNA. These examples work across student mathematical working in classrooms, the teaching of mathematics and teacher education and curricula.

13.2 Mathematical ‘Structure’ and ‘Structuring’

While there is broad agreement of the importance of ‘structure’ within mathematics, what structure refers to is frequently less clear. Sfard (1991) has contrasted ‘structural’ conceptions with ‘operational’ conceptions, with the former described in terms of processes that come to be solidified into encapsulating objects that have a ‘static structure’ (p. 20). Mason et al. (2009) describe mathematical structure in terms of:

the identification of general properties which are instantiated in particular situations as relationships between elements. (p. 10)

Mathematical properties are important in this formulation in that, for these authors, recognising relationships between elements is not, in itself, a marker of structural thinking. Rather, it is when these relationships are recognised as ‘instantiations of properties’ that the onset of structural thinking is marked. Thus, while building attunement to pattern- and relation-recognition is critical within ‘structuring’ activity and viewed as a valuable precursor to attending to structure, instruction needs to provide openings for these relationships to be associated with fundamental properties. In the context of WNA, a range of fundamental properties are introduced. These include, for example, ideas related to equivalence, associativity and compensation and the nature of and distinction between additive and multiplicative structures. All of these properties are usually initially exemplified in natural number contexts, but can be extended beyond the boundaries of WNA. Rational number provides a key ground for studies focused on these extensions, with the expanded terrain providing grounds for looking at the ways in which the impacts of operational properties shift – e.g. multiplication no longer necessarily ‘making bigger’ and, conversely, division no longer necessarily ‘making smaller’.

Given the centrality of linking specific relationships to more general properties, approaches focused on structure and structuring activity are commonly linked to algebraic thinking. Algebra topics and algebraic thinking are predictably, therefore, key foci for looking at connections between WNA and other areas.

Two broad positions on mathematical structure can be inferred within the literature base. These can be distinguished on the basis of structures that are presented

‘ready-made’ to support problem-solving activity or structures that emerge through structuring activity. In mathematics education, particular approaches have tended to align more within one, or other, of these camps. Bourbakian approaches, for example, have worked from the vantage point of emphasis on structure (Corry 1992), while Realistic Mathematics Education placed more emphasis on structuring activity as the means through which mathematical structures are reinvented (van den Heuvel-Panhuizen and Drijvers 2014). Working from the basis of definitions linked to properties therefore provides a key hallmark of working with structure. Working in more emergent ways for ‘taken as shared’ reinventions of structure provides, in contrast, a key hallmark of structuring activity. In either case, Mason et al. (2009) note that it is awareness of general properties, rather than awareness of internal relations within instances, that indicates, for them, possible presences and potential for structures to figure as thinking tools.

While both of these positions have advocates, there are also critiques that are important to be mindful of within operationalisation of the positions and their ensuing claims. A key issue that Freudenthal (1973) pointed to as problematic about traditional mathematics teaching was what he described as the ‘anti-didactical’ use of models in a ‘top-down instructional design strategy in which static models are derived from crystallized expert mathematical knowledge’ (Gravemeijer and Stephan 2011, p. 146). Artigue (2011) has more recently echoed this critique, noting that ‘pupils do not know which needs are met by the mathematical topics introduced’ and, concomitantly, that they therefore have ‘little autonomy in their mathematical work’ (p. 21). Presenting structures in a ‘ready-made’ format can be construed as incorporating some elements of this orientation. Venkat et al. (2014) have noted that within early primary years’ teacher education in South Africa, attention to definitions of properties – key markers of structural relations – may not be sufficient without supporting attention to the example spaces in which the properties can be strategically applied. They point to data drawn from a small study in which early primary teacher educators, when asked to propose a set of examples for working on commutativity, included examples with the first number larger than the second number alongside examples where the second number was larger. One excerpt they point to includes the following explanation from a teacher educator with the offer of $9 + 3$:

‘We can say that this is the same as $3 + 9$ using commutativity’.

In this response, there is clearly awareness of the commutativity property and what it means to apply the commutativity property to an addition example, but perhaps more limited attention to *when* it might be useful to apply this property. There was also no explanation of the distinctions between the totality of the space of all additive examples to which the former general definition applies as a structural property and the latter subspace in which useful application holds. Venkat et al. (2014) described these shortcomings in terms of a ‘definitional’ rather than a ‘strategic’ orientation to structural properties. These findings point to limitations of dealing with definitions as the sole source of structure and point to additional features

that need to be part of the discussion if flexible and strategic working with mathematical properties is sought.

Conversely, the focus on individual reinvention activity has also been critiqued from several perspectives: these include arguments that the approach has always been more a function of political ideology than educational effectiveness and, therefore, dependent for its suitability on a broader political climate of autonomy (Tabulawa 2003), to reviews of key areas of education research arguing that there is more support for the efficacy of:

direct, strong instructional guidance rather than constructivist-based minimal guidance during the instruction of novice to intermediate learners. [...] Not only is unguided instruction normally less effective; there is also evidence that it may have negative results when students acquire misconceptions or incomplete or disorganized knowledge. (Kirschner et al. 2006, pp. 83–84)

In relation to structuring activities specifically, Schifter (2011) – while not arguing for the direct instruction position – does indicate that attention to structure is developed through experience with tasks that promote attention to structure and emphasises that this attention can begin in the context of WNA. She provides useful contrastive examples of two ways of dealing with the following task:

Oscar had 90 stickers and decided to share some with his friends. He gave 40 stickers away.
Becky also had 90 stickers. She gave away 35 stickers. Who has more stickers now? (p. 207)

In one class, no further discussion follows, and the children proceed to calculate Oscar and Becky's remaining stickers and then compare the two answers in order to answer the question. In the second class, after checking that the children are aware that the subtraction sentences $90 - 40$ and $90 - 35$ can be used to represent the two scenarios, the teacher explicitly tells her class that she wants them to consider who would be left with more stickers *without* calculating. She proceeds to orchestrate a discussion which is focused on comparing the effects of 'taking away more' and 'taking away less' from a quantity. Considering and articulating the properties of subtraction, rather than the operation of subtracting, are therefore at the fore here. Other writers have echoed this broadly 'cultural' position in that skill with structuring is seen as dependent upon, and an outcome of, participating in structuring activities (e.g. Wright et al. 2006). In parallel, though, there are also studies that have pointed to the need for teachers, at least, to have prior cultural familiarity with WNA structures – such as WNA representations based on the decimal number system structure – as a precursory support for being able to work with these structures constructively in mathematics classrooms if the mathematical ideality of these artefacts, inlaid into their material structure, is to be realised (Bakhurst 1991).

In this chapter, our focus is on studies that exemplify these two positions. The studies themselves encompass links between WNA and a range of other mathematical topic areas, including rational number and measurement, but our focus in this chapter is specifically on the position they take in relation to working with structures and structuring activity. The approaches used within these two positions, and differences specifically in the ways in which models are viewed and produced, are explored. We do this in order to explore overlaps and contrasts between the two

positions in terms of the ways in which connections between WNA and algebraic thinking can be achieved via an emphasis on structures and structuring. We also attend to whether there is evidence that one or other of these approaches may be more appropriate when focusing on primary mathematics teacher education.

13.3 Investigating and Supporting Structuring Activity

Pattern and sequence tasks are commonly promoted in mathematics curricula across the world as contexts in which attention to structure and generalisation can be encouraged (Driscoll 1999). Hewitt (1992) has pointed to openings for linking spatially based orientations to pattern (rather than numerically based orientations) to openings for generalising. He also notes the latter ‘pattern-spotting’ orientation through translating spatial arrangements into tabular numerical summaries as limiting openings for attending to the various ways in which a particular spatial structure can be constructed and considering constructions that have structural similarities across instances. Spatial approaches to visual-pictorial patterns are seen in Eraky and Guberman’s (2015) inclusion of sequences presented in this format. While these authors note that primary students in Israel largely found it harder to make general statements in visual-pictorial pattern formats in comparison with numerical formats, their claim of the need to ‘go deeper into the rules of building a sequence’ (p. 548) at least partially reflects Hewitt’s argument that spatial pattern formats and attention to pattern construction and verbalisation of this construction provide better routes into attending to structure than the more common numerically oriented routes.

Of broader interest for us is the linking here between numerical, algebraic and spatial approaches to working with structuring. Ferrara and Ng (2015) provide a more distributed notion of the development of algebraic thinking in the context of visual pattern tasks, focusing on the ways in which two Grade 3 children’s identifications of mathematical structures develop in the assemblage of human and material resources. In looking at the emergence of structuring, rather than at children’s competence with identifying a correct overall generalised functional representation, these authors emphasise the ways in which specific spatial arrangements give rise to increasing emphasis on the numerosity of partial elements, or more holistic views of these arrangements and numerical relations between elements in children’s talk. Ferrara and Ng note also the ways in which the assemblage of material artefacts including the task and task conditions, and the children’s gestures and talk, all feed into supporting moves into WNA and functional thinking.

Warren and Cooper (2009) introduced two complementary representations, the balance scale and the number line, to model equivalence in a longitudinal study through Grades 2–6. From their study, they suggest a theory for a learning/teaching trajectory which supports generalised understanding of equivalence. Their conjectures propose that the act of translation between effective representations is one of the key points for constructing structured understanding of WNA that can be gener-

alised beyond WNA. They offer the construction of superstructures, where multiple models are nested and integrated, as elucidation and conclude that ‘the role of superstructures cannot be underestimated’ (p. 92).

A small cluster of work involved studies working at the interface of structures and structuring. In these studies, tasks incorporating situations underscored by differences in their structure or tasks in which the emergent introduction of structure and relation produces substantial efficiencies in calculation are used to encourage children to focus on structural aspects. In the Measure Up programme in Hawaii, teaching begins with general ideas in a measurement context without using numbers, based on ideas from Davydov (Venenciano et al. 2015). Venenciano and her colleagues reported on first grade students’ learning and conceptual understanding of place value by measurement of continuous quantities with different bases rather than focusing on special cases of the decimal structure and discrete numbers. They demonstrate students’ ability to focus on the constant ratio between the units of adjacent places and emphasise that the unit of measure is a ‘critical tool for both the conceptual and the physical development of partial units (e.g. thirds in base three or tenths in base ten)’ (p. 581). By approaching place value in the measurement context through this approach, these authors noted that children were provided with opportunity to experience the notion of referent units as a general idea as well as instances of different bases as the measure unit. Tasks and tools underlain by a pedagogic awareness of the importance of structure are seen as central in this work to support children’s structuring activity.

Paying attention to distinguishing multiplicative situations from additive situations, Larsson and Pettersson’s (2015) paper presented details of a study in which Swedish sixth grade students were engaged in solving and comparing two covariation problems, one multiplicative and one additive, both set in the same context of children swimming lengths in a pool. They found that children who successfully solved both problems discerned the mathematically significant feature of the intensive quantity speed. These students further inferred from the speed what impact the speed had on the distance between the swimmers – indicating understanding of the properties that could be associated with this structural relation. These authors provide examples of this understanding in excerpts drawn from the talk of two students – Jonathan and Marcus (all names are pseudonyms):

Jonathan: Because he swims faster [Jonathan moved two fingers simultaneously along the table with one finger moving faster]

Marcus: If they are equally fast then of course she keeps that distance. [Marcus holds his hands on a fixed distance from each other and moves them forward at the same pace.] (p. 562)

Less successful students did not discern the speed as significant or, in spite of discerning it, did not make any inference from the speed about the distance between the swimmers. Matilda and Hanna expressed these differences when they compared the two problems, but that did not lead them to question their solutions, which were to treat both problems as if they were of an additive nature:

Matilda: They start at the same time and they do not start at the same time.

Hanna: And those two do not swim equally fast and those two swim equally fast. (p. 563)

Here, the ability to discern and distinguish the nature of structural relations between quantities in given situations is noted as central to successful mathematical problem solving.

The ability to distinguish between additive and multiplicative situations, but also to reason about the mathematical structure of a problem in terms of different additive or multiplicative situations, is discussed by Nunes et al. (2012) as what they denote to be mathematical reasoning. An example from their longitudinal study, involving 1680 children over a 5-year time period, is based on two similar problems where the distance between two persons is to be calculated, where one problem is solved by subtraction and the other by addition, since the persons travelled in the same or different directions along a road. They found the ability to recognise the mathematical structure to be a strong predictor for later achievement in mathematics, much stronger than arithmetic skills, logical thinking or working memory, hence recommending more emphasis on reasoning about the mathematical structure in mathematics instruction. This study's results coincide with findings from van Dooren et al. (2010), where students who categorised problems before solving similar problems were more successful than those who solved problems before categorising. The problems were similar to the problems in Larsson and Pettersson's (2015) study, i.e. additive and multiplicative covariation problems and also no variation problems formulated in the same format, such as if it takes 8 mins to boil 5 eggs, how much time do you need to boil 10 eggs concurrently. The amount of time it takes to boil the eggs does not vary here no matter how many eggs there are. The students who first categorised and later solved problems were not only better at distinguishing the mathematical structure and solved more problems correctly; they were also better at the categorisation task than their peers who solved problems before categorising.

This finding links with Ellis' (2007) distinction between arithmetic operations and quantitative operations. While arithmetic operations are driven towards evaluating quantities, quantitative operations are driven towards evaluating the structural relationships between quantities in a given situation. Working with quantitative operations, in these terms, is therefore at the fore of Larsson and Pettersson's tasks rather than arithmetical operations, with this orientation reflected too in the emphasis on identifying structural similarity that is seen across task sequences in Askew's (2005) 'Big Book of Word Problems' series. Of further interest in relation to structuring activity more generally is Ellis' finding that different types of 'generalising actions' were prevalent in classrooms promoting one or other of these two approaches. Her notion of 'relating' as one key aspect of generalising activity – described in terms of the creation of relationships between:

two or more problems, situations, ideas, or mathematical objects. Relating includes recalling a prior situation, inventing a new one, or focusing on similar properties or forms of present mathematical objects. (p. 454)

– was much more prevalent in classrooms promoting attention to quantitative rather than arithmetical operations.

Chen et al.'s (2015) study adds a further dimension to this work by adding in consideration of students' problem-posing competence, alongside attention to their calculation and problem-solving competence. Aligning with the earlier work of Dole et al. (2012), Chen et al. (2015) emphasise that variations in the emphases in their classroom learning experiences (across calculation, contextualised problem solving and problem posing), and the specific numbers and number relations in the problem sets, impact upon the ways in which children interpret structural relationships in problem situations. In the calculation activities, students were required to compute eight number sentences represented in different combinations of number types (i.e. combining a multiplier/divisor and multiplicand/dividend smaller and larger than 1): four decimal multiplications (i.e. 1.3×2.7 , 2.4×0.9 , 0.8×3.6 and 0.6×0.7) and four decimal divisions (i.e. $3.6 \div 1.2$, $5.4 \div 0.9$, $0.8 \div 1.6$ and $0.6 \div 0.2$). In the contextualised problem-solving activities, students had to solve eight word problems on decimal multiplication and division containing the number sentences from the calculation (e.g. A kilo of bananas costs 1.3 Yuan. I buy 2.7 kilos. How much do I pay?). In the contextualised problem-posing activities, students were required to pose problems according to the same eight number sentences as in the calculation. For example, students were required to pose problems according to the number sentence:

$$1.3 \times 2.7$$

Chen et al. (2015) found that students did well in interpreting the structural relationships in terms of multiplication/division operations in calculation and contextualised problem-solving activities but not in contextualised problem-posing activities. Alongside this, they also found that across the three different learning experiences, it was more difficult to interpret the structural relationships in terms of multiplication/division operations with a decimal multiplier/divisor smaller than 1 than those with a decimal multiplier/divisor larger than 1. Additionally, it was more difficult to interpret the structural relationships with a dividend smaller than the divisor than those with a dividend larger than the divisor. For example, quite a few students (7%) gave a wrong answer '2' for the calculation item ' $0.8 \div 1.6$ ', and a substantial proportion of students (33%) provided a wrong answer ' $1.6 \div 0.8 = 2$ ' for the problem-solving item:

1.6 kilos of carrots is 0.8 Yuan. How much are carrots per kilo?

Another sizeable proportion of students (15%) provided a wrong answer such as 'Xiao Hua bought 0.8 kg of bananas, and she spent 1.6 Yuan. How much are bananas per kilo?' in response to the problem-posing item ' $0.8 \div 1.6 = 0.5$ '.

Taken together, these findings suggest that there may be a useful distinction to be made within Ellis' (2007) quantitative operations category, between tasks geared more towards problem solving and those geared more towards problem posing. This suggests that Watson and Mason's (2005) emphasis on encouraging students to generate examples given specific constraints and/or relations as a way of encouraging attunement to structure and a move away from the calculation orientations that dominate more traditional mathematics instruction may be particularly important. While the examples presented in their work range across several mathematical top-

ics and levels, there are a number of examples presented of tasks and approaches that encourage attention to structure in the context of WNA and to the ways in which properties and relations shift in the moves beyond WNA boundaries. Examples include tasks such as (adapted slightly for our purposes):

Write a pair of numbers that multiply to give 100.

And another pair...

And another pair...

Now write a pair of numbers that multiply to give 100, but one of your numbers has to be between 50 and 100.

Now write a pair of numbers that multiply to give 100, but one of your numbers has to be bigger than 100.

Attention to structural relations and equivalence are at the fore here, with an explicit focus on the boundaries of the example spaces that are usually constructed around multiplication. In this approach, attention to the ways in which properties shift and need reconstruction in order for more general conceptions to be created is opened up for students to work with.

Another example of a route into attention to structural and quantitative operations that stimulated students to find general relations was to prompt sixth grade students to evaluate suggested but erroneous strategies (Larsson 2015). Among the suggested strategies was the idea that 19×26 can be calculated as 20×25 instead, based on the reasoning that you can move one from 26 to 19, just as in addition. This calculation strategy came from earlier interviews in the same group of students who participated in the study. When the students investigated the strategy rather than the numerical example (and hence working quantitatively and not arithmetically), some succeeded not only in finding the strategy invalid, but also building explanations for why the strategy was invalid. These explanations included structural arguments as well as elaborations of the conditions under which the answer would get bigger than the original task. After an elaborated discussion with a peer, one student concluded thus:

if you increase the smaller number and decrease the larger number, then it always gets bigger.

This student also stated that he had only investigated the strategy in WNA and that his statement was not yet tested with rational numbers. Students who solved the task by only checking the two answers by calculation (and hence construing the task as an arithmetic operation exercise) practised their calculation skills and could tell that the strategy was invalid but without any reasoning of why. They typically stated that it became another task when you moved one from one factor to the other. This example can be linked to what Smith and Thompson (2008) have distinguished as ‘numerical/computational solutions’ and ‘quantitative/conceptual solutions’ (p. 107). In their discussion of what early algebra should focus on, they argue that quantitative reasoning in WNA during the early school years prepares students in much broader and more flexible ways for algebra in the later school years. In their argumentation for more focus on quantitative reasoning, they describe the border

between numerical and quantitative reasoning as indistinct and note that numerical reasoning can and should serve as a starting point to think about relations.

Reasoning in the context of numerical examples with a focus on structure is predominant in the ‘Peter’s method’ activity, which Stephens (2004) employed in a study with elementary students. Peter’s method was to avoid subtraction that involves renaming, or carrying over, by adding the number that can be followed by subtracting ten. It was presented to students with the example of subtraction of 5 from a two-digit number, shown as involving the adding of five and then subtracting of ten, as in $43 - 5 = 43 + 5 - 10$. If the students demonstrated structural reasoning when this and similar examples were discussed, the task was elaborated to include other numbers, for example, subtraction by 6, with the challenge to find what number to add in order to then subtract ten to evaluate the answer, for example:

$$34 - 6 = 34 + ? - 10$$

The findings from his study indicated that students who could ignore the starting number (the minuend quantity) could also answer why and how Peter’s method *always* worked, in contrast to students who first undertook the calculation of the left side of the equality sign. The desire to find a numerical answer rather than a general explanation appeared to be associated with hindering students to reason quantitatively. Nevertheless, it is an example of quantitative reasoning that originated in the context of a numerical operations task, with an adaptation that encouraged the structure to be brought into focus. In this sense, the approach overlaps with the approach discussed in the study about evaluation of erroneous calculation strategies that Larsson (2015) presented. Similar activities and classroom observations starting in investigations of WNA examples (but engaging young students to discern relational and structural properties) are described by Bastable and Schifter (2008) as a way to prepare for the transfer of operations beyond WNA into rational numbers.

13.4 Working with Presented Structures with Students

Attention to structure is seen within the presentation and discussion of generalised definitions, models and representations of relations between quantities, with similarities between the artefacts offered to learners and teachers but often differences in the emphases of the ensuing conversations around these artefacts. In this section, we discuss studies that have foregrounded structure at the student level and at teacher level.

Mellone and Ramploud (2015), using the working concept of *cultural transposition*, explored the processes involved in providing Italian children with a figural equation model representing an additive relation structure that has commonly been used in Russia and China. *Cultural transposition* is a process where ‘the different cultural backgrounds generate possibilities of meaning and of mathematics education perspectives that, in turn, organise the contexts and school mathematics prac-

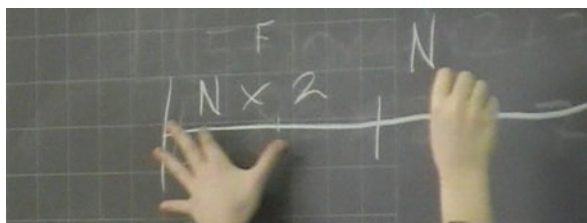
Fig. 13.1 The child's hand

tices in different ways' (Mellone and Ramploud 2015, p. 571). The authors argue that there are differences in emphases and role of the diagrammatic part-part-whole model in the Russian and Chinese contexts that link with cultural and linguistic differences in orientations to meaning, distinction and categorisation. In their analyses of the common practice in China of presenting sets of 'variation problems', the figural equation is explicitly presented as a unifier across variations and, thus, an explicit representation of a generalised property of additive relation situations. In contrast, they argue that Davydov's (1982) presentations of the part-part-whole model functions instead as a transition step between a graphic (non-quantified) situation and a symbolic algebra-based model. This 'intermediary' role for the figural equation has, though, been disputed within Davydov-linked approaches in the work of Dougherty and Slovin (2004), who argue the need for the simultaneous, rather than sequential, presentation of graphic, figural and symbolic models of structure in order to support student meaning-making. Both approaches though emphasise a push towards algebraic thinking from the outset of work in the context of WNA, rather than the more common deferral of algebraic work to a subsequent point.

Analysis of the ways in which a Grade 5 Italian primary school class solved the following problem provides empirical data related to both structural attention and the cultural transpositions involved in taking on approaches with origins in different contexts:

Grandmother gifts 618 euros to her grandchildren, Franca, Nicola and Stefano. Franca receives twice Nicola's amount; Stefano receives 10 euros more than Nicola. How many euros will each grandchild receive?

Children solved this problem in activity groups. Given the focus in this chapter on working with structure, an important feature of the data presented by Mellone and Ramploud (2015) relates to the ways in which children developed and used figural equations to help themselves to find the solution. A key aspect, documented in the dataset (Electronic Supplementary Material: Ramploud et al. 2017), dataset, shows one group's sharing of their solution approach with the whole class. It is evident from the movement of the child's hand (Fig. 13.1) that the amount for Nicola is used as a measure to draw the figural equation. Of importance to us is that there is an abandonment of the focus on an arithmetical problem and that this is replaced by a focus on structures in ways that are related to informal algebra. The writing of the expression $N \times 2$ (Fig. 13.2) is an important part of this shift in orientation. In this example, we can see the Italian cultural transposition of the Russian tradition, which emphasises

Fig. 13.2 The expression $N \times 2$

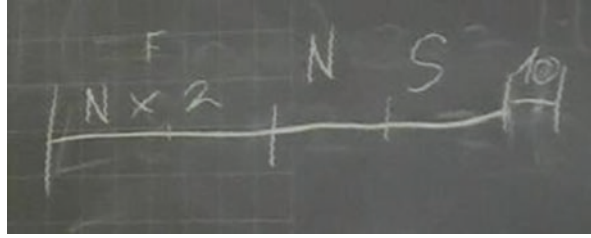

continuous representations of quantity, and of the Chinese tradition in which the emphasis on numerical size is retained.

Mellone and Ramploud (*ibid.*) report positive results in their *cultural transposition* of the figural additive relations equation into an Italian Grade 5 classroom, noting that the structural rather than numerical emphasis of this model was associated with supporting pupils towards a more natural and flexible recourse to algebraic language in this context. This result supports and adds cultural nuance to earlier work pointing to the importance of encouraging attention to structure and generality in the context of WNA as a means of supporting both numerical calculation and later transitions into more formal algebra (Cai and Knuth 2011; Schifter 2011).

Building further on cross-cultural curriculum evaluation, Xin and colleagues developed the conceptual, model-based, problem-solving (COMPS) programme (Xin 2012) that is consistent with the theoretical framework of mathematical modelling and conceptual models (e.g. Blomhøj 2004; Lesh et al. 1983). The COMPS approach places emphasis on algebraic representation of generalised mathematical relations in equation models. For instance, ‘Part + Part = Whole’ is a conceptual model for additive word problems; ‘Unit Rate \times Number of Units = Product’ (Xin 2012, p. 5) is a conceptual model for multiplicative equal-group (EG) problems. Giving the generalised mathematical models provided by COMPS, a range of arithmetic word problems involving the four basic operations can be represented and modelled in an algebraic equation, which can be used to help students solve problems.

To this end, Xin developed a set of word problem (WP) *story grammar* questions (see Figs. 13.3, 13.4, 13.5 and 13.6) to facilitate students’ efforts in representing various word problems in the model equation. The algebraic equation then drives the solution process, that is, solve for the unknown quantity in the equation. During this process, the choice of operation for solving various arithmetic word problems is determined by the model equation (Part + Part = Whole; or Factor \times Factor = Product). In the case of EG problem-solving (see Fig. 13.3), for instance, when the *number of units* is the unknown (e.g. *Dan has a total of \$114 for buying gifts for his friends. If each gift costs \$19, how many gifts can he buy?*), the model equation ($19 \times a = 114$) indicates that dividing the product (114) by the known factor (19) will solve for the unknown factor ($a = 6$). In the case of *multiplicative compare* (MC) problem solving (see Fig. 13.4), for instance, when the *referent unit* is the unknown (e.g. *Pat has 204 marbles. Pat has 17 times as many marbles as Bob. How many marbles does Bob have?*), the model equation ($a \times 17 = 204$) shows that dividing the *product*

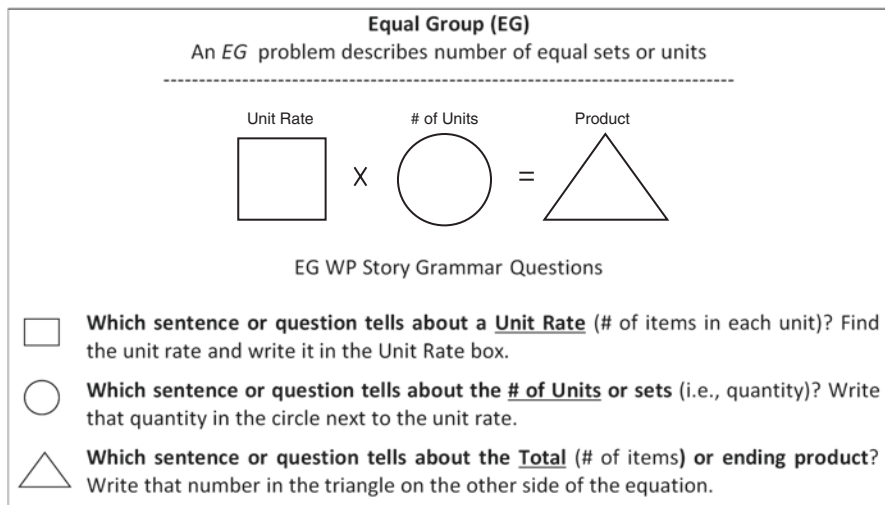

Fig. 13.3 Conceptual model of *equal groups* problems (Xin 2012, p. 105)

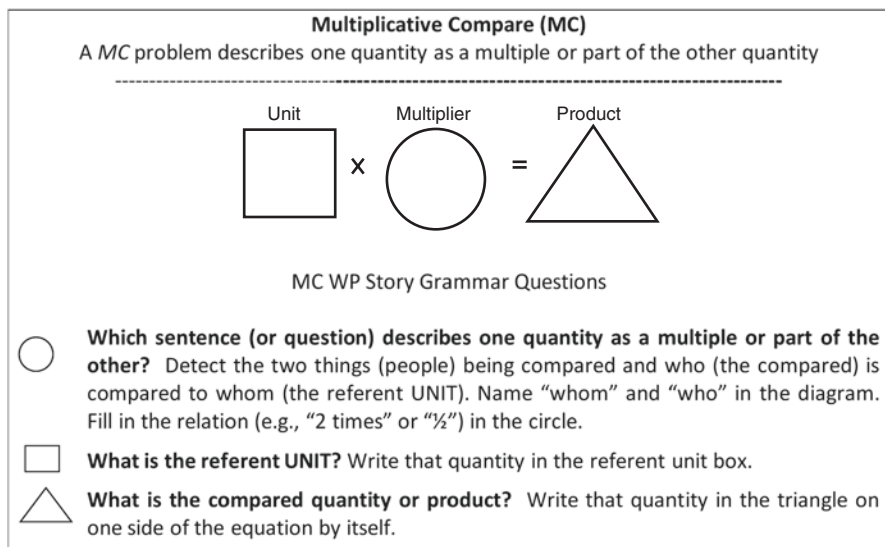

Fig. 13.4 Conceptual model of *multiplicative compare* problems (Xin 2012, p. 123)

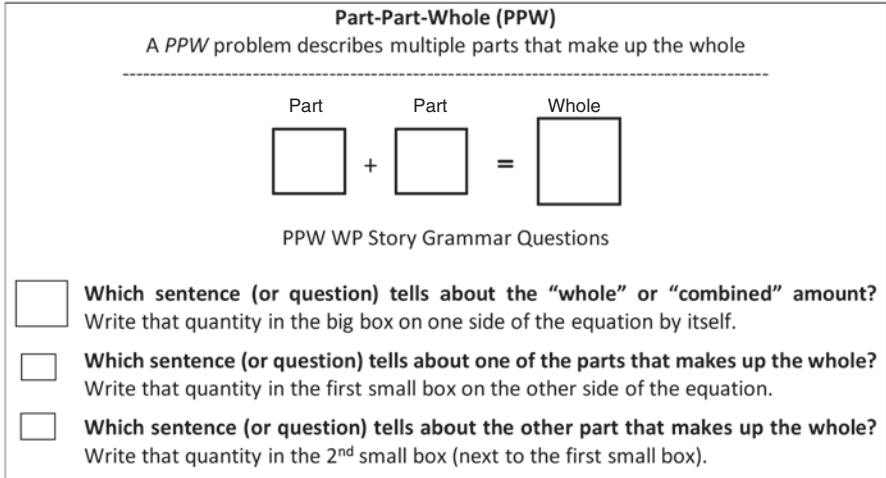

Fig. 13.5 Conceptual model of *part-part-whole* problems (Xin 2012, p. 47)

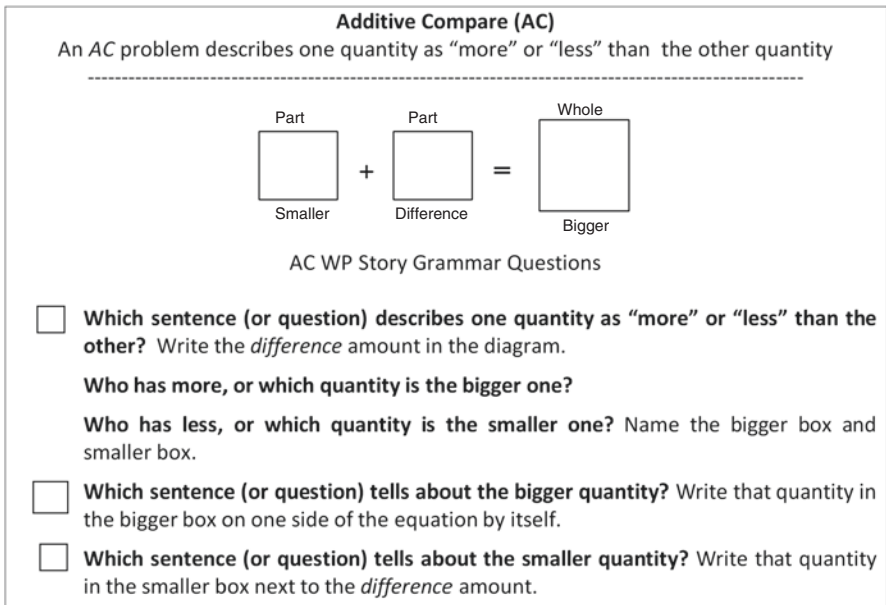

Fig. 13.6 Conceptual model of *additive compare* problems (Xin 2012, p. 67)

(204) by the *multiplier* (17) will solve for the unknown quantity ($a = 12$). Students no longer need to ‘gamble’ on the choice of operation or experience risk on the ‘keyword’ strategy.

As shown in Figs. 13.3, 13.4, 13.5 and 13.6, Xin (2015) presents structure in the form of algebraic representations of generalised conceptual models of additive and multiplicative situations and uses them as a heuristic model to support the problem-solving activities of elementary and middle school students with learning difficulties. Empirical data drawn from using this approach indicate that students who used the COMPS programme showed significant improvement in mathematics problem-solving performance (Xin et al. 2011).

13.5 Working with Presented Structures with Teachers

At the level of teacher education, a range of approaches driven by the need for teachers to make greater use of the power of structure in their pedagogy has been presented in recent studies. We discuss several studies that investigated how teachers reasoned about multiplicative and proportional relationships using presented structures. Quite predictably, there are also overlaps in this section with the chapter on teacher education in this publication (Chap. 17).

In their work with future middle grades teachers (Grades 4–8), Beckmann et al.¹ (2015) view multiplicative structure quantitatively in terms of multiplier, multiplicand and product and use the different roles taken by the multiplier and multiplicand as a route into thinking about proportional relationships in two different ways, as either ‘multiple batches’ or ‘variable parts’ (Beckmann and Izsák 2015). In their approach, multiplication is defined by an equation:

$$M \cdot N = P$$

where M , the multiplier, is a number of groups; N , the multiplicand, is the number of units in 1 group; and P , the product, is the number of units in M groups. The future teachers in the study adopted the definition as a class norm. This definition is quantitative, as opposed to purely numerical, because the multiplier, multiplicand and product have measurement units attached to them (‘groups’ and ‘units’) and therefore refer to quantities. Because the definition is quantitative, the multiplier and multiplicand play different roles and, using the definition, requires teachers to look for and identify structure in situations. The rationale for a presented structure is therefore to foster close examination of situations and attention to detail in constructing arguments.

For example, Figs. 13.7 and 13.8 show two ways that a future teacher in Beckmann et al.’s (2015) study reasoned to solve a proportion problem: A fertiliser

¹Research was supported by the National Science Foundation under Grant No. DRL-1420307. The opinions expressed are those of the author and do not necessarily reflect the views of NSF.

is made by mixing nitrogen and phosphate in an 8:3 ratio and the question is how much phosphate to mix with 35 kg of nitrogen. The teacher's first solution (Fig. 13.7) takes a multiple-batches perspective. She views the fertiliser as some number of batches of an 8 kg nitrogen and 3 kg phosphate mixture, structures the 35 kg of nitrogen as a number of groups of 8 kg of nitrogen and structures the required amount of phosphate as that same number of groups of 3 kg of phosphate.

The same teacher's second solution to the same fertiliser problem (Fig. 13.8) takes a variable-parts perspective. This time the teacher views the fertiliser as eight parts nitrogen and three parts phosphate, where all parts are the same size. She determines the size of each part by structuring the eight parts nitrogen as eight groups that contain a total of 35 kg and structures the required amount of phosphate as three groups of that size.

Although the results are preliminary and part of a larger, ongoing project, in Beckmann et al.'s (2015) study, many pre-service teachers were similarly able to present well-constructed arguments for solving proportionality problems from two perspectives. We also note that a presented structure could be a useful organiser for the field. Although a multiple-batches perspective on proportional relationships has been well known in mathematics education research for many years, the existence of a separate variable-parts perspective was only recently discussed in mathematics education research (Beckmann and Izsák 2015). This is even though limitations of a multiple-batches perspective were recognised (Kaput and West 1994) and variable-parts solution methods were known. For example, the model method used in Singapore (see Kaur 2015) lends itself to a variable-parts perspective. By structuring proportional relationships through a quantitative definition of multiplication, we see the existence of two distinct quantitative ways of conceptualising proportional relationships.

Venkat (2015) similarly pointed to improvements in in-service teacher performance in South Africa on a ratio task following exposure to generalisable double number line models, introduced in the context of whole number situations but usable and used in decimal number (money) contexts as well. Structure, in her approach, was presented in the form of key representations of the structure of multiplicative situations – double number lines and ratio or 'T-tables' – that were introduced, discussed and used in their in-service teacher education programme. Evidence drawn from teacher assessment tasks in the course indicated that for some teachers, these 'structured' representations were taken up as tools that facilitated moves towards successful mathematical problem solving that allowed for the production of correct answers, while for other teachers, the same structured representations were taken up as pedagogic objects with associated explanations that could better support students to produce correct answers. Across both groups, there was evidence of greater elaboration of problem-solving processes, in ways that broader literature suggests are useful for teaching.

This finding is of interest in relation to the literature base on primary mathematics teacher knowledge where there is broad evidence that being able to do mathematics for oneself provides limited promise for competence with teaching mathematics to others. Essentially, the argument is that the latter competence

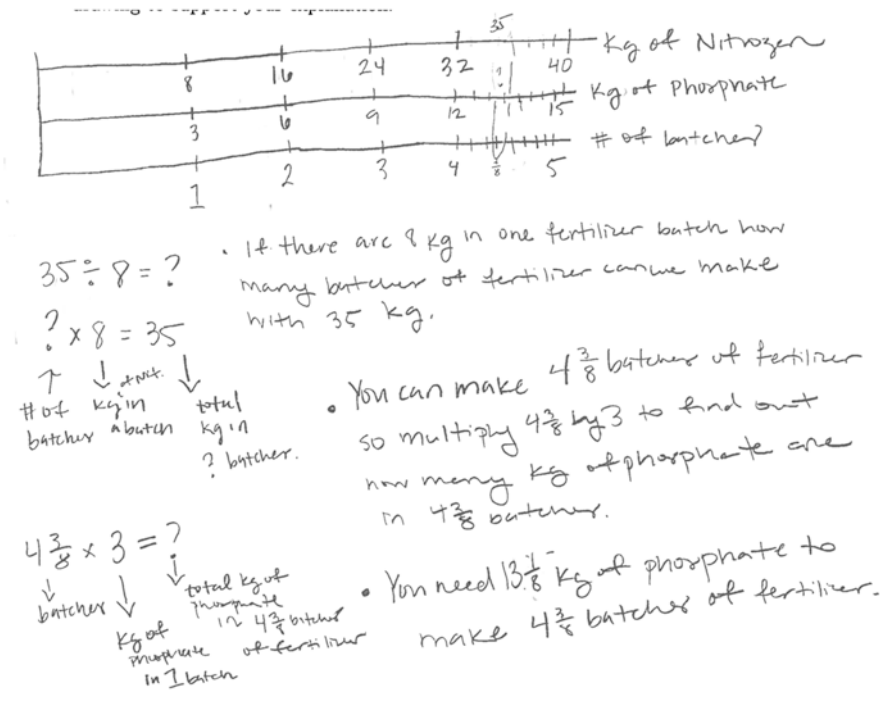

Fig. 13.7 Reasoning about proportional relationships from a multiple-batches perspective

requires an additional, ‘specialised’ knowledge base (Ball et al. 2008). As a group, we concur with this argument, but note from Venkat’s (2015) work that a focus on key representations, introduced and discussed in the context of WNA, appeared to be an important component that worked simultaneously to support the development of competences related to teachers’ working with mathematics and their teaching of mathematics. In a South African context marked by discursive gaps in pedagogy, this kind of approach, focused on generalised representations of structure, serves to address development in what a trajectory of work, of which Adler and Ronda’s (2015) paper is the most recent, has described as teachers’ ‘mathematical discourse in instruction’.

Dole et al. (2015) attribute problems for students in recognising and working with multiplicative reasoning to ‘the limited capacity of primary school curricula to promote multiplicative structures’ (p. 535). In trying to address this shortcoming through an in-service teacher development project, Dole et al.’s team presented and discussed a range of proportional relation situations drawn from the Australian curriculum document, from other subject areas and from real life, encouraging focus on their structural similarity and their contrast with the structure of additive relation situations. Through this approach, they noted shifts in teachers’ awareness of links between topic areas in the curriculum that had previously been viewed as separate

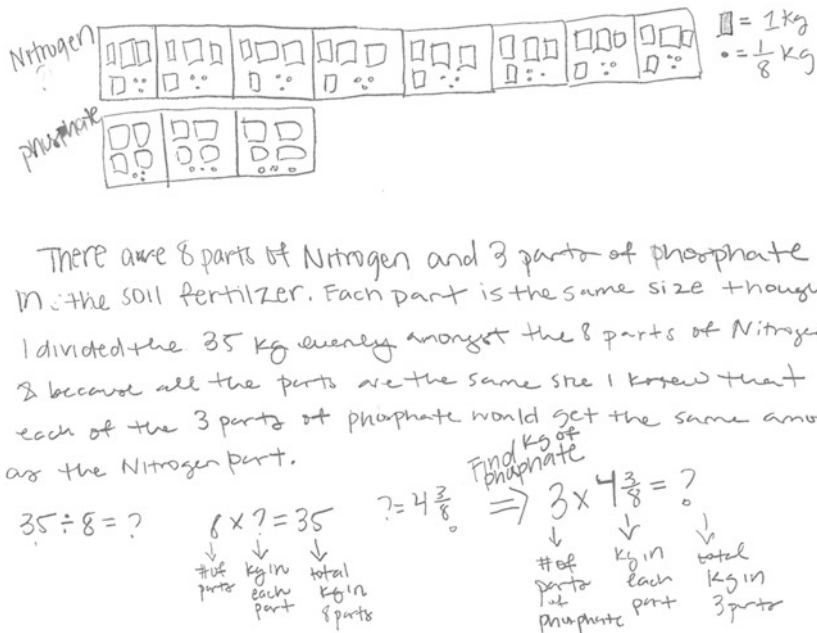

Fig. 13.8 Reasoning about proportional relationships from a variable-parts perspective

and competence with pointing to this similarity when working with situations underpinned by a multiplicative structure.

13.6 Conclusions, Implications and Future Directions

Across the papers in the two broad sections focused on ‘structures’ and ‘structuring activity’, there is general agreement that incorporating attention to developing awareness of structure should be an important component of work in WNA, in order to support early algebraic thinking. There are also several useful pointers towards approaches that appear to hold promise for the development of attention to structure in the WNA context in ways that have longevity beyond the boundaries of WNA. Given the evidence of students’ cognitive difficulties in the transition from natural numbers to rational numbers (van Hoof et al. 2013), and the concomitant evidence of ‘natural number bias’ (Ni and Zhou 2005), the latter aspect is particularly important. We summarise these approaches here, noting emphases on particular features and phases within this evidence:

- There are indications that situations involving spatial awareness can provide useful springboards for WNA working in ways that relatively ‘naturally’ and usefully include attention to structural relations.

- Distinguishing between additive and multiplicative situations, as well as between different structures within additive and multiplicative situations, appears to be an important avenue into developing understanding of the different underlying structures of these situations. Problem posing in relation to given structures appears to be particularly complex and, therefore, openings for encouraging students to engaging with linking or constructing problems with given structural relations would seem to be an important area for further attention.
- For older children and for teachers, more ‘top-down’ presentations of structure in generalised word sentence or algebraic formats seem to have purchase in drawing attention to the nature of quantitative relations being worked with. This could well be related to, and acknowledging of, extensive prior encounters with additive and multiplicative situations. Parallel approaches for younger children appear to be better supported by the presentation of pictorial models of underlying structure that can be used in similar ways to develop more powerful discourses about the nature of quantitative relations in additive, multiplicative and other patterned situations involving some structural relations.

The importance of awareness of structural relations in a range of problem contexts has been widely acknowledged in mathematics education research. Our focus in this chapter has been on distinguishing between two key alternatives into developing this awareness. Whether working with offered structures or being invited to construct relations through structuring activity, the common centrepiece is inviting students and/or teachers to think more deeply about the mathematical structure of problems. Nunes et al. (2012) have noted that this kind of thinking can and should be developed in the context of WNA, with work in additive and multiplicative relation situations providing fertile ground from the earliest stages of mathematical learning for both learning about structure and learning to distinguish between structures. Both approaches provide the means for seeing numerical and spatial situations (and quite possibly mathematical situations more generally) as contexts that are open to structuring and to seeing in terms of structure. Mathematical activity in this orientation is viewed as fundamentally concerned with identifying structure and possible generality. At one level, this focus opens possibilities for seeing WNA as a ground with continuities into rational and real number arithmetic. A larger outcome, though, of the focus on structure and structuring is a breaking down of some of the high walls of arithmetic operations around WNA contexts, which so many children (and, importantly, many teachers) in so many parts of the world appear to have such difficulty in scaling and seeing beyond.

References

- Adler, J., & Ronda, E. (2015). A framework for describing mathematics discourse in instruction and interpreting differences in teaching. *African Journal of Research in Mathematics, Science and Technology Education*, 19(3), 237–254.

- Artigue, M. (2011). *Challenges in basic mathematics education*. Retrieved from Paris: <http://unesdoc.unesco.org/images/0019/001917/191776e.pdf>.
- Askw, M. (2005). *BEAM's big book of word problems for years 3 & 4*. London: BEAM Education.
- Bakhurst, D. (1991). *Consciousness and revolution in Soviet philosophy: From the Bolsheviks to Evald Ilyenkov*. Cambridge: Cambridge University Press.
- Ball, D. L., Thames, M. H., & Phelps, G. (2008). Content knowledge for teaching: What makes it special? *Journal of Teacher Education*, 59(5), 389–407.
- Bastable, V., & Schifter, D. (2008). Classroom stories: Examples of elementary students engaged in early algebra. In J. Kaput, D. Carraher, & M. Blanton (Eds.), *Algebra in the early grades* (pp. 165–184). New York: Lawrence Erlbaum Associates/National Council of Teachers of Mathematics.
- Beckmann, S., & Izsák, A. (2015). Two perspectives on proportional relationships: Extending complementary origins of multiplication in terms of quantities. *Journal for Research in Mathematics Education*, 46(1), 17–38.
- Blomhøj, M. (2004). Mathematical modelling – A theory for practice. In B. Clarke et al. (Eds.), *International perspectives on learning and teaching mathematics* (pp. 145–159). Göteborg: National Center for Mathematics Education.
- Cai, J., & Knuth, E. (Eds.). (2011). *Early algebraization*. New York: Springer.
- Corry, L. (1992). Nicolas Bourbaki and the concept of mathematical structure. *Synthese*, 92(3), 315–348.
- Davydov, V. V. (1982). The psychological characteristics of the formation of elementary mathematical operations in children. In T. P. Carpenter et al. (Eds.), *Addition and subtraction: A cognitive perspective* (pp. 224–238). Hillsdale: Lawrence Erlbaum.
- Dougherty, B. J., & Slovin, H. (2004). Generalized diagrams as a tool for young children's problem solving. In *Proceedings of the 28th conference of the International Group for the Psychology of Mathematics Education* (Vol. 2, pp. 295–302).
- Dole, S., Clarke, D., Wright, T., & Hilton, G. (2012). Students' proportional reasoning in mathematics and science. In T. Tso (Ed.), *Proceedings of the 36th conference of the International Group for the PME* (Vol. 2, pp. 195–202). Taipei: PME.
- Driscoll, M.J. (1999). *Fostering algebraic thinking: A guide for teachers grades 6–10*. Portsmouth, NH: Heinemann.
- Ellis, A. B. (2007). The influence of reasoning with emergent quantities on students' generalizations. *Cognition and Instruction*, 25(4), 439–478.
- Freudenthal, H. (1973). *Mathematics as an educational task*. Dordrecht: D. Reidel Publishing Company.
- Gravemeijer, K., & Stephan, M. (2011). Emergent models as an instructional design heuristic. In K. Gravemeijer, R. Lehrer, B. van Oers, and L. Verschaffel (Eds.), *Symbolizing modeling and tool use in mathematics education* (pp. 145–169). Dordrecht: Kluwer Academic Publishers.
- Hewitt, D. (1992). Trainspotters' paradise. *Mathematics Teaching*, 140, 6–8.
- Kaput, J. J., & West, M. M. (1994). Missing-value proportional reasoning problems: Factors affecting informal reasoning patterns. In G. Harel & J. Confrey (Eds.), *The development of multiplicative reasoning in the learning of mathematics* (pp. 235–287). Albany: State University of New York Press.
- Kirschner, P. A., Sweller, J., & Clark, R. E. (2006). Why minimal guidance during instruction does not work: An analysis of the failure of constructivist, discovery, problem-based, experiential, and inquiry-based teaching. *Educational Psychologist*, 41(2), 75–86.
- Larsson, K. (2015). Sixth grade students' explanations and justification of distributivity. In K. Krainer & N. Vondrová (Eds.), *Proceedings of the Ninth Congress of European Research in Mathematics Education* (pp. 295–301). Prague: Charles University, Faculty of Education and ERME.

- Lesh, R., Landau, M., & Hamilton, E. (1983). Conceptual models in applied mathematical problem solving research. In R. Lesh & M. Landau (Eds.), *Acquisition of mathematics concepts & processes* (pp. 263–343). New York: Academic Press.
- Mason, J., Stephens, W., & Watson, A. (2009). Appreciating mathematical structure for all. *Mathematics Education Research Journal*, 21(2), 10–32.
- Ni, Y., & Zhou, Y.-D. (2005). Teaching and learning fraction and rational numbers: The origins and implications of whole number bias. *Educational Psychologist*, 40(1), 27–52.
- Nunes, T., Bryant, P., Barros, R., & Sylva, K. (2012). The relative importance of two different mathematical abilities to mathematical achievement. *British Journal of Educational Psychology*, 82(1), 136–156.
- Schifter, D. (2011). Examining the behavior of operations: Noticing early algebraic ideas. In M.G. Sherin, V.R. Jacobs, & R.A. Philipp (Eds.), *Mathematics teacher noticing: Seeing through teachers' eyes* (pp. 204–220). New York/London: Routledge.
- Schoenfeld, A. H. (1988). When good teaching leads to bad results: The disasters of ‘well-taught’ mathematics courses. *Educational Psychologist*, 23(2), 145–166.
- Sfard, A. (1991). On the dual nature of mathematical conceptions: Reflections on processes and objects as different sides of the same coin. *Educational Studies in Mathematics*, 22(1), 1–36.
- Smith, J. P., III, & Thompson, P. W. (2008). Quantitative reasoning and the development of algebraic reasoning. In J. Kaput, D. Carraher, & M. Blanton (Eds.), *Algebra in the early grades* (pp. 95–132). New York: Lawrence Erlbaum Associates/National Council of Teachers of Mathematics.
- Stephens, M. (2004). The importance of generalisable numerical expressions. In B. Clarke et al. (Eds.), *International perspectives on learning and teaching mathematics* (pp. 97–111). Göteborg: National Centre for Mathematics Education.
- Tabulawa, R. (2003). International aid agencies, learner-centred pedagogy and political democratization: A critique. *Comparative Education*, 39(1), 7–26.
- van den Heuvel-Panhuizen, M., & Drijvers, P. (2014). Realistic mathematics education. In S. Lerman (Ed.), *Encyclopedia of mathematics education* (pp. 521–525). Dordrecht/Heidelberg/New York/London: Springer.
- van Dooren, W., De Bock, D., Vleugels, K., & Verschaffel, L. (2010). Just answering...or thinking? Contrasting pupils' solutions and classifications of missing-value word problems. *Mathematical Thinking & Learning*, 12(1), 20–35. doi:[10.1080/109860600903465806](https://doi.org/10.1080/109860600903465806).
- van Hoof, J., Lijnen, T., Verschaffel, L., & van Dooren, W. (2013). Are secondary school students still hampered by the natural number bias? A reaction time study on fraction comparison tasks. *Research in Mathematics Education*, 15(2), 154–164. doi:[10.1080/1479802.2013.797747](https://doi.org/10.1080/1479802.2013.797747).
- Venkat, H., Askew, M., & Runesson, U. (2014). Definitional vs strategic example spaces for mental strategies. Sep 1st – 3rd. EARLI SIG 9 conference: Phenomenography and variation theory: Oxford.
- Warren, E., & Cooper, T. (2009). Developing understanding and abstraction: The case of equivalence in the elementary years. *Mathematics Education Research Journal*, 21(2), 76–95. doi:[10.1007/BF03217546](https://doi.org/10.1007/BF03217546).
- Watson, A., & Mason, J. (2005). *Mathematics as a constructive activity: Learners generating examples*. Mahwah: Lawrence Erlbaum.
- Wright, R. J., Stanger, G., Stafford, A. K., & Martland, J. (2006). *Teaching number in the classroom with 4–8-year-olds*. London: Sage Publications.
- Xin, Y. P. (2012). *Conceptual model-based problem solving: Teach students with learning difficulties to solve math problems*. Rotterdam: Sense Publishers.
- Xin, Y. P., Zhang, D., Park, J. Y., Tom, K., Whipple, A., & Si, L. (2011). A comparison of two mathematics problem-solving strategies: Facilitate algebra-readiness. *The Journal of Educational Research*, 104(6), 381–395.

Cited papers from Sun, X., Kaur, B., & Novotna, J. (Eds.). (2015). Conference proceedings of the ICMI study 23: Primary mathematics study on whole numbers. Retrieved February 10, 2016, from www.umac.mo/fed/ICMI23/doc/Proceedings_ICMI_STUDY_23_final.pdf

- Baldin, Y., Mandarino, M. C., Mattos, F. R., & Guimaraes, L. C. (2015). A Brazilian project for teachers of primary education: Case of whole numbers (pp. 510–517).
- Beckmann, S., Izsák, A., & Ölmez, I.B. (2015). From multiplication to proportional relationships (pp. 518–525).
- Chen, L., van Dooren, W. Jing, M., & Verschaffel, L. (2015). Effect of learning context on students understanding of the multiplication and division rule for rational numbers (pp. 526–533).
- Cooper, J. (2015). Combining mathematical and educational perspectives in professional development (pp. 526–533).
- Dole, S., Hilton, A., Hilton, G., & Goos, M. (2015). Proportional reasoning: An elusive connector of school mathematics curriculum (pp. 534–541).
- Eraky, A., & Guberman, R. (2015). Generalisation ability of 5th–6th graders for numerical and visual-pictorial patterns (pp. 542–549).
- Ferrara, F., & Ng, O.-L. (2015). A materialist conception of early algebraic thinking (pp. 550–558).
- Kaur, B. (2015). The model method: A tool for representing and visualizing relationships (pp. 448–455).
- Larsson, K., & Pettersson, K. (2015). Discerning multiplicative and additive reasoning in co-variation problems (pp. 559–566).
- Mellone, M., & Ramplood, A., (2015). Additive structure: An educational experience of cultural transposition (pp. 567–574).
- Venenciano, L., Slovin, H., & Zenigami, F. (2015). Learning place value through a measurement context (pp. 575–582).
- Venkat, H. (2015). Representational approaches to primary teacher development in South Africa (pp. 583–588).
- Xin, Y.P. (2015). Conceptual model-based problem solving (pp. 589–596).
- Zhang, J., Meng, Y., Hu, B., Cheung, S.K., Yang, N., & Jiang, C. (2015). The role of early language abilities on math skills among Chinese children (pp. 597–602).

Open Access This chapter is licensed under the terms of the Creative Commons Attribution 4.0 International License (<http://creativecommons.org/licenses/by/4.0/>), which permits use, sharing, adaptation, distribution and reproduction in any medium or format, as long as you give appropriate credit to the original author(s) and the source, provide a link to the Creative Commons license and indicate if changes were made.

The images or other third party material in this chapter are included in the chapter's Creative Commons license, unless indicated otherwise in a credit line to the material. If material is not included in the chapter's Creative Commons license and your intended use is not permitted by statutory regulation or exceeds the permitted use, you will need to obtain permission directly from the copyright holder.



Chapter 14

Structuring Structural Awareness: A Commentary on Chapter 13



John Mason 

14.1 Introduction

It was a great pleasure to read Chap. 13 with its wide-ranging scope concerning different ways in which mathematical structure can play out in primary classrooms in the context of whole numbers and with its wide-ranging suggestions for structuring tasks so as to foster significant encounters with mathematical structure.

As Towers and Davis (2002) observe, the term *structure*, etymologically linked to ‘strew’ and ‘construe’, has been used in mathematics education in two rather contrasting senses. Its biological use, which underpins Piaget’s genetic epistemology, refers to complex, constantly evolving, co-emergent, contingent and co-implicated forms; its architectural use refers to static interlocked components. Steffe and Kieren (1996) suggest that educational research has been impeded by conflation of these two meanings.

My aim here is to augment Chap. 13 with some examples of tasks which seem to me to promote encounters with mathematical structure and to suggest some directions for future development. The first section offers some observations concerning the recognition of relationships and transition to generalisation through attending to properties being instantiated, drawing on my own experience in supporting the teaching of mathematics. I mention them because they capture something of the growth of my awareness of how mathematical structure can be avoided or circumvented unwittingly through inappropriate pedagogic choices. This segues into a few remarks about attention and structured variation. The final section draws explicitly on Chap. 13 to suggest some potentially worthwhile directions for further study and development.

J. Mason (✉)
The Open University, Milton Keynes, UK
e-mail: john.mason@open.ac.uk

14.2 Detecting Mathematical Structure as Recognising Relationships

In the 1970s, as I became more and more involved in the issues and concerns of teaching and learning mathematics, I was inspired by the Midland Mathematics Experiment (1964). There I found sequences of figures made variously out of matchsticks and shapes such as squares and circles. I was excited by them because they seemed to me to offer multiple opportunities for learners to imagine what was *not* present, but which extended what *was* present according to some fixed relationships, multiple opportunities to express those relationships and multiple opportunities to develop algebraic expressions for the number of elements required to make a specific but as yet unknown figure in that sequence.

14.2.1 Expressing Generality

I developed and incorporated dozens of tasks involving sequences of figures in materials designed to support teachers of mathematics at all ages, from early years to secondary school (Mason 1988, 1996). One of the most important principles for me was the necessity that learners formulate a verbal statement of how a pattern continued or how the instances presented fitted into some extendable pattern. Only then is it worth counting the number of objects required. One of my favourites was a figure that we used for an assessment question for would-be and practising teachers upgrading their qualifications (Fig. 14.1).

The reason for choosing 50 and 32 is to see whether the action of scaling (multiply columns by 10) is either invoked before they have really thought about the situation or used because they want an easy calculation. Then we can talk about *parking* the first action that becomes available and considering whether other actions might be more appropriate or effective. Thus, the task affords possibilities for work on *inner* and *meta* tasks as well as the *outer* task (Tahta 1981; see also Mason and Johnston-Wilder 2004, 2006).

If I were using the task myself, I would exploit the fact that different people may ‘see’ the configuration differently, and I might even extend it to include asking peo-

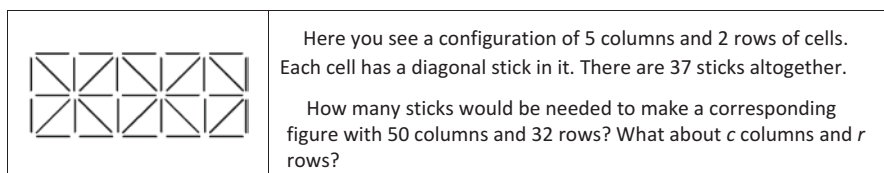

Fig. 14.1 A stick configuration

ple to find at least three different-looking expressions for the number of sticks and to indicate how these express different ways of seeing how to build such figures. This is about seeking structure through recognising relationships (one of the forms of attention). The reason is to promote multiplicity in ways of seeing and expressing those ways of seeing symbolically. Not only does this multiplicity lead naturally to the rules of algebra, in order to manipulate different looking expressions that are known to express the same thing, but it is allied to and reinforces *parking*.

On the original assessment, we found that many of the teachers could cope with generalisation in one direction (number of columns), but not with generalising two things at once. This led me to promote making a copy of the figure for yourself and watching how your body naturally finds an efficient way of doing it (perhaps by doing all the horizontals first or by building column by column). The slogan Watch What You Do (WWYD) emerged as a way to be reminded to do this and applies whenever you are specialising, that is, constructing a simpler specific example of something in order to get a sense of structural relationships. This too was encapsulated in a slogan as *Manipulating–Getting-a-sense-of–Articulating* (Floyd et al. 1981; see also Mason and Johnston-Wilder 2004, 2006).

Seeking several expressions of the same generality in lots of different situations eventually leads to the question of whether there is a way to move between equivalent expressions without going via the verbal description that they express. We called this *multiple expressions* and promoted it as a route to algebra, because the ‘rules’ for manipulating letters can be developed and expressed by learners themselves when the desire to do so arises (Mason et al. 1985, 1996).

Some years later, I realised what Mary Boole (Tahta 1972) might have meant when she talked about a particular route to generalisation. I called it *tracking arithmetic*, and it involves carrying out calculations without actually touching one or more of the initial numbers. In the case of the matchsticks, this means finding a way to count the number of sticks but not touching the 5 (for columns) or the 2 (for rows). It requires expressing everything in terms of these two numbers. Thus, the horizontal sticks are counted by $5 \times (2 + 1)$, the vertical sticks by $2 \times (5 + 1)$ and the diagonal sticks by 2×5 . Overall, this means that $3 \times (2 \times 5) + 5 + 2$ sticks are needed. The untouched 2s and 5s can now be replaced by r and c , respectively, to give the expression $3rc + r + c$ for the number of sticks required, perhaps by first going through and marking all the occurrences of 2 as a row count and 5 as a column count. Note also the symmetry between r and c .

Tracking arithmetic (Mason et al. 2005) has proved a powerful route into algebra when working with ‘algebra-refusers’: learners who have decided that algebra is not for them. Instead of letters, I use a cloud to stand for some as-yet-unknown number that someone outside of the room is thinking of. Then I proceed to get them to express some relationships, and to their surprise, they find that what they have done is actually algebra!

A further development (particularly but not exclusively at secondary level) is to ask whether there is a figure corresponding to some specified number S of sticks. Since $S = 3rc + r + c$, it turns out that $3S + 1 = 9rc + 3r + 3c + 1 = (3r + 1)(3c + 1)$. Thus, S sticks can be used to make such a figure if and only if $3S + 1$ can be

Fig. 14.2 A part of a frieze pattern



expressed as the product of two numbers both of the form one more than a multiple of 3. Furthermore, this structural reasoning can be generalised. It can be used on any expression of the form $axy + bx + cy + d$ with suitable adjustments to take into account b , c and d . Not that this reasoning is accessible to young children, but it is worthwhile at least raising the undoing question so as to immerse learners in the ubiquitous and creative theme of *doing* and *undoing*: whenever you find you can perform some action, the *doing*, ask whether or in what circumstances you can *undo* it (Mason 2008).

The importance of deciding how all the figures are to be drawn, even those not yet displayed, before embarking on counting, cannot be overstated. In other situations, it is vital that there is some predetermined rule or structure for generating the terms of the sequence. For example, the figure 14.2 is part of a frieze pattern, but without any further information, you cannot be certain how it continues. However, if you are told that it is generated by a repeating block of cells and that the repeating block appears at least twice, you can extend the frieze in only one way (Mason 2014; Fig. 14.2).

Only when you have decided how it continues does it make sense to ask questions such as the shading of the 100th cell (the n th cell) and the cell number of the 100th occurrence (the n th occurrence) of a lightly shaded cell, which are the *doing* and the *undoing* questions. WWYD is still pertinent.

This sort of task has been exploited with pre-school children, where they make up their own intricate patterns and extend their own and those made by others (e.g. Papić and Mulligan 2007; Ferrara and Sinclair 2016). Slightly older children can, with suitable support, proceed to count the numbers of objects required in general and even to extend their thinking to negative numbers (e.g. Moss and Beatty 2006). Zazkis and Liljedahl (2002) report various studies indicating that learners may not find such tasks straightforward, but usually this can be explained by unfamiliarity with expressing generality as part and parcel of thinking mathematically. As Chap. 13 points out, it all has to do with a pedagogy that is in alignment and consistent with a teacher's ways of thinking about mathematics as a creative endeavour rather than as a process of training behaviour to carry out mindless procedures. Thus, effective teaching is not simply about the mathematical structure and the structural relationships that govern a situation, and it is not simply about the choice of task or how it is structured. It is also about sequence and structure of pedagogical moves made by the teacher in setting up the task and in interacting with the learners. It is all of these, informed by a perspective on and experience of mathematics that values mathematical thinking as much as it does answers.

It was only after many years that I realised how easily learners' behaviour can be trained and how learners conspire (often unwittingly) to circumvent thinking (active cognition). For example, I used always to present the first three or four figures in a sequence, but eventually I realised that this led to learners paying more attention to

how the figures change from one to the next than to the internal structure of each individual figure (Stacey 1989; Stacey and MacGregor 1999, 2000). Sometimes this inductive approach is powerful, and indeed the only way to proceed, but the main purpose of inviting learners to generalise from sequences was to get them to express generality, counting the number of objects needed to make the n th picture without recourse to the previous ones. These tasks were intended to develop students' powers so that the teaching of every topic intimately involved learners expressing generality for themselves and justifying it. Offering sporadic instances or even a single 'generic' instance is one way to avoid falling into the trap of learners becoming dependent on a particular format for such tasks.

There arose for me the question of what students were attending to when they did, and when they did not, detect and express generality in different situations.

14.2.2 Attention

Having spent a long time trying to get to grips with what it means to attend to something, I eventually discerned five forms or structures of attention, building on ideas of Bennett (1966; see also 1993), only to find that they were in close alignment with the van Hiele levels (van Hiele-Geldof 1957; van Hiele 1986). Where I differ rather significantly is that in my experience the different ways of attending to something are highly mutable. They are not levels to be climbed like some staircase. I describe these forms of attention as *holding wholes* (gazing at some 'thing' which may be visible or imagined), *discerning details* (some details may become a whole to be gazed at), *recognising relationships* in a particular situation, *perceiving properties* as generalities being instantiated in the particular and *reasoning on the basis of agreed properties* (Mason 2003).

At the core is the movement back and forth between recognising relationships (a sense of structure in the form of structural relationships, but only in the particular) and perceiving properties as general structural relationships being instantiated. I conjecture that, in mathematics, many students rarely if ever explicitly experience properties being instantiated, and consequently the world of mathematics remains closed to them. I popularised this in the UK with the slogan 'A lesson without the opportunity for learners to generalise mathematically is not a mathematics lesson' (Mason et al. 2005). In other words, generalisation is the life and soul, the heart of mathematical thinking. So when we promoted figural generalisations, it was only to provide learners with experience of generalisation. Our main proposal is, was and always has been that teaching mathematics means immersing learners in a culture of generalisation, prompting learners to express generalities as conjectures and trying to convince themselves and others that their conjectures (suitably modified) are actually correct. This applies to each and every topic and each and every lesson. It aligns with a Davydov-inspired approach to number which focuses on units before introducing number.

Table 14.1 A grid

$3 \times (1 + 1)$ = $3 \times 1 + 3 \times 1$	$3 \times (1 + 2)$ = $3 \times 1 + 3 \times 2$	$3 \times (1 + 3)$ = $3 \times 1 + 3 \times 3$...
$3 \times (2 + 1)$ = $3 \times 2 + 3 \times 1$	$3 \times (2 + 2)$ = $3 \times 2 + 3 \times 2$	$3 \times (2 + 3)$ = $3 \times 2 + 3 \times 3$...
$3 \times (3 + 1)$ = $3 \times 3 + 3 \times 1$	$3 \times (3 + 2)$ = $3 \times 3 + 3 \times 2$	$3 \times (3 + 3)$ = $3 \times 3 + 3 \times 3$...
...

14.2.3 Structured Variation Grids

The notion of structured variation arose from a situation in the town of Tunja in Colombia, in which I was asked how to teach factoring of quadratic expressions to learners who were unsure about the answer to $(-1) \times (-1)$. I came up with what I called Tunja sequences (Mason 2001a). The idea is to call upon learners' natural powers to extend familiar sequences and then to get them to interpret what they have done, using what Anne Watson (2000) has called *with and across the grain*. A simplified version for use with young children in a whole number context might be the above (Table 14.1).

Going *with the grain* means being able to predict what will be in each cell by detecting and exploiting the familiar sequence of natural numbers, by analogy with splitting wood. Going *across the grain* is about recognising why it is that the two calculations in each cell always give the same answer, by analogy with seeing the structure of the rings of a tree stump.

Having an applet which enables you to reveal one or other side of the equal sign in any cell makes it easy to show a few parts of a few cells and then to invite learners to conjecture and justify and then check other cells. It is a format in which to provoke generalisation. Learners can then be asked to make up a similar grid for themselves. On a different day, the multiplier 3 can be changed. It doesn't take long for learners to conjecture and articulate the distributive law of arithmetic and, when expressed as a generality, the distributive law for algebra. Similar grids can be used in upper primary or lower secondary for expanding brackets and factoring (Mason 2015). Note that the effectiveness of structured variation grids lies not in the structure of the grids themselves, though this plays an important role, but in the pedagogic choices that are made, either in preparation or in the moment by moment unfolding of a lesson, informed by a perspective on mathematics conducive to learners taking initiative.

Here, the structural relationships which underpin arithmetic are brought to the surface, articulated and then internalised through direct personal experience. Similarly, the multiplication of negative numbers can be addressed by a multiplica-

tion grid that extends to the left and down into negative numbers. Going with the grain along rows and columns fills in the cells; going across the grain recognises why multiplying negative numbers works as it does. Recognising that the calculations are correct in each cell and that the left-to-right presentation could be reversed involves attention to specific structural relationships, perceiving the entries in cells as the instantiation of general properties. There are other grids which involve operations on fractions.

14.2.4 Comment

The reason for presenting some historical developments in my appreciation of obstacles to learning was to provide some specific examples of mathematical structure and to indicate how the shift from recognising relationships in the particular to perceiving properties as being instantiated lies at the heart of school mathematics. Arithmetic is most usefully seen as the study of properties of numbers; getting answers to specific calculations could become a by-product rather than the focus of attention.

14.3 Possible Directions of Development

To my mind, it would be really helpful if mathematicians and mathematics educators could come to some sort of agreement on how to think about mathematical topics, both as experiences in themselves and in relation to other mathematical topics and to mathematical thinking as a whole. I preface some of my suggestions with a pertinent extract from Chap. 13, marked by an attention point.

14.3.1 Expressing Generality

There are indications that situations involving spatial awareness can provide useful springboards for WNA working in ways that relatively ‘naturally’ and usefully include attention to structural relations.

As Chap. 13 indicates, there is growing evidence that young children can detect, copy and extend patterns and can create complex patterns for themselves. Teachers can initiate such tasks in the midst of almost any other work (e.g. during theme work on the polar regions, making sequences from polar bears, penguins and seals or whatever is the focus of attention). What matters is the rich way in which pedagogic choices promote the development of children’s natural powers to think mathematically, moving from pattern repetition to counting what is visible to counting what is only imagined and, so, to expressing generality (Mason 1996). It would be helpful

to teachers to have more clear descriptions of how teachers have done this with pupils and how pupils have created their own.

14.3.2 Additive and Multiplicative Reasoning

Distinguishing between additive and multiplicative situations, as well as between different structures within additive and multiplicative situations, appears to be an important avenue into developing understanding of the different underlying structures of these situations. Problem posing in relation to given structures appears to be particularly complex and, therefore, openings for encouraging students to engaging with linking or constructing problems with given structural relations would seem to be an important area for further attention.

Chapter 13 reports research which indicates that structures such as the double number line and the empty number line can be useful for presenting a visual structure which can inform number calculations. To these could be added Numicon, Cuisenaire rods and Exercise Elastics (to manifest multiplication as scaling, of which repeated addition is a special case; see Harvey 2011). What seems to matter most is not the apparatus itself, but how it is used. Mathematics is only embodied in physical objects when someone ‘sees’ it as embodied, so it is all down to pedagogic choices. More work is needed concerning how pedagogic choices influence learners’ seeing mathematics as embodied.

14.3.3 Mathematical Vision

Ball (1993) points to the importance of teachers’ mathematical vision (mathematical horizon), which includes connections to other topics, relationships to ubiquitous mathematical themes, exploitation of learners’ natural powers to think mathematically and, most specifically, places where a topic has found use or application in the past. In Chap. 13, it is observed that rarely do learners have any sense of where what they are doing fits into a bigger picture, and possibly this is because teachers are similarly unsure about a bigger picture. Artigue (2011) is quoted as echoing this, noting that ‘pupils do not know which needs are met by the mathematical topics introduced’ and, concomitantly, that they therefore have ‘little autonomy in their mathematical work’ (p. 21). Autonomy can be fostered by taking every opportunity to get learners to make significant as well as routine choices.

Connections and vision are enriched through awareness of mathematical themes, such as invariance in the midst of change, doing and undoing, and freedom and constraint (Mason and Johnston-Wilder 2004, 2006). This is part of a framework for preparing to teach any topic. At the Open University, we developed such a framework, called in its later manifestations SoaT (Structure of a Topic). It brings to the surface six aspects of any mathematical topic corresponding to some degree with

three aspects of the human psyche as recognised by Western psychology, namely, cognition, affect and enaction.

The cognitive axis concerns aspects such as concept images (the associations and images that are usefully associated with the topic; the concept images) together with classic confusions and uncertainties that arise for learners in the topic. The enactive axis includes looking for how terms used technically in the topic are based on or derived from everyday words and the ‘inner incantations’ or ‘patter’ (Wing 2016) that can usefully accompany the carrying out of techniques and procedures, as well as the procedures themselves. The affective axis, being connected with emotions and motivation. And hence with desire and disposition, includes the sorts of problem(s) that the topic resolves, the problems that historically gave rise to the topic and in what contexts the topic has proved to be useful. It also includes questions about how the pedagogic choices are likely to support the development of a positive disposition towards the topic, its language, its concepts and its techniques.

Because different groups of students in different situations are different, it does not seem reasonable to try to find one perfectly effective way to introduce students to algebra. An alternative is to see that there are several routes into algebra (generalising structural relationships and expressing these; tracking arithmetic; multiple expressions for the same thing; axioms of arithmetic expressed generally so as to be the rules of algebra). What is worth dwelling on in any particular lesson depends on the people and the situation, so this is where the art of the teacher is required. Lessons based on textbooks which are in turn based on a single hypothetical learning trajectory (Simon and Tzur 2004) are likely to succeed sometimes, but not always. Successful teaching requires sensitivity both to the mathematics (topic and thinking) and to learners, because teaching mathematics is a caring profession. Balancing care for mathematics and for learners is not at all easy. As is well known, two people co-planning a lesson and then teaching it very often end up doing quite different things because of all the differences. Fundamentally, the issue is what the teacher is aware of (what pedagogical and mathematical actions become available) and what they are currently sensitised to notice. That is what makes the difference between effective (in the long term) and successful (in the short term) teaching.

When teachers are themselves thinking mathematically, whether alone or collectively, there is an ethos and a sensitivity to learners that fades when teachers stop doing mathematics themselves.

14.3.4 Word Problems

The use and abuse of word problems has been much discussed (Gerofsky 1996; Greer 1997; Verschaffel et al. 2000, Mason 2001a, b). Since word problems seem to be unavoidable, it seems sensible to work with them structurally. Some people have tried to teach learners to analyse verbal statements, to locate keywords and, from these, to work out how to find an answer, while the so-called Singapore method is to depict quantities using a bar diagram and then work with them. Ultimately, what

has to happen is that the learner uses their mental imagery to enter into the situation to recognise and express relationships in the situation using whatever support devices and modes of presentation are recommended for this purpose. Word problems cannot be solved effectively at ‘arm’s length’ so as to avoid thinking.

As Bednarz et al. (1996) noted, in arithmetic you proceed from the known to the unknown, whereas in algebra you start with the unknown and proceed towards the known. But, as Mary Boole (Tahta 1972) pointed out, what you do is acknowledge your ignorance and denote what you do not yet know by some symbol, and then you express what you do know using that symbol. This is tantamount to tracking arithmetic, when you start by trying to check whether some guess is actually the answer but track that guess so that it can be replaced by a symbol, in order to reach some equations to solve.

If word problems are treated as a domain of play and exploration, so that learners construct their own, changing the context as well as numerical parameters, then the power to imagine a situation, to locate structural relationships and to express them can be enjoyed rather than feared. For example, take the simple context of sharing marbles:

If Anne gives 3 of her marbles to John, they will then have the same number. How many more marbles did Anne have than John to start with?

Of course, you could also be told how many marbles one or the other has afterwards. But look at all the potential dimensions of possible variation, all the features that can be changed: the number of marbles Anne gives away, the effect of her giving them away (maybe she then has twice as many, or half as many, or 5 more than, or 6 less than John), the number of people involved, the number of actions of giving and receiving involved (perhaps John then gives Anne some marbles or gives some to someone else, etc.), the nature of the actions (perhaps Anne exchanges each of her red marbles for two of John’s blues, etc.) and the things being exchanged (sweets, counters, teddy bears, penguins, etc.). Pleasure can be obtained from making up your own variations and trying to resolve them, not simply in the particular, but in the general. This can be done (in simple instances) with very young children, inducting or enculturating them into the ways of mathematical thinking.

Again, it is not the mathematical structure alone (how daunting is a page full of ‘problems’ to be required to ‘do’?), and it is not the pedagogical structure of the task and the interactions, but the two of these together, mediated or held together by the sensitivity of the teacher both to opportunities for mathematical thinking and the particular thinking of her learners.

14.3.5 Pedagogic Choices

For older children and for teachers, more ‘top-down’ presentations of structure in generalised word sentences or algebraic formats seem to have purchase in drawing attention to the nature of quantitative relations being worked with. This could well

be related to, and acknowledging of, extensive prior encounters with additive and multiplicative situations. Parallel approaches for younger children appear to be better supported by the presentation of pictorial models of underlying structure that can be used in similar ways to develop more powerful discourses about the nature of quantitative relations in additive, multiplicative and other patterned situations involving some structural relations.

Chapter 13 covertly acknowledges that terms like ‘direct instruction’ are far from being unambiguous, being used to refer to a wide range of practices. For example, they quote Kirschner et al. (2006 pp. 83–84) to the effect that ‘unguided instruction [is] normally less effective’ than strong instructional guidance. But surely no-one proposes ‘unguided instruction’. Even the much maligned ‘discovery learning’ espoused by Bruner (1966) never meant learners being left on their own to ‘discover’ without any intervention or guidance. The delicacy and importance of an informed awareness, including awareness of awareness (Mason 1998), cannot be overstated.

‘Top-down’ or ‘direct instruction’ is often interpreted as the teacher telling learners what to do, perhaps on a worked example, perhaps as a sequence of instructions. But working in a whole-class plenary mode need not be like this. Rather, the teacher can draw out learners’ ideas and can focus and direct attention while calling upon learners to make use of and develop their own powers. Teachers can *shepherd* (Towers 1998; Towers and Proulx 2013). Teachers can summon learners’ past experience. Then a little bit of ‘telling’ can indeed be telling, can be effective when it occurs at an appropriate moment (Love and Mason 1992, 1995). Time for learners to work for themselves, to develop a personal narrative or self-explanation (Chi and Bassok 1989), and time for learners to try out their articulations with colleagues and to hear other learners’ narratives is also important. What seems most important is not to be prescriptive as to how a lesson should go. Rather, teachers need to be supported in developing sensitivities to notice, to be aware of, what and how learners are thinking, so that the tasks are used richly. Retaining the complexity of teaching is vital, responding to and making use of the rich complexity of the human psyche, rather than trying to simplify acts of teaching as if on an assembly line. A contribution to structuring teacher-learner interactions can be found in the six modes described in Mason (1979), which outline six modes of interaction based on the systematics of Bennett (1966, 1993). To these can be added the five strands of *mathematical proficiency* proposed by Kilpatrick et al. (2001), the five dimensions of *mathematically powerful classrooms* proposed by Schoenfeld (2014) and the habits of mind articulated by Cuoco et al. (1996). There are probably many others. More work is needed on simplifying and coordinating the many different ways of preparing oneself to make effective pedagogic choices when planning and, in the moment, preserving the complexity of the human psyche but not overcomplicating it.

For example, Davis (1996) introduced the notion of *hermeneutic listening* in which the teacher listens *to* what learners are saying and watches what learners are *doing*, rather than listening *for* what they want to hear or watching *for* what they want to see. One way to sensitise yourself to listening to is through what Malara and Navarra (2003) called *babbling*, by analogy with a young child in a cot making the

sounds of sentences without yet having the words. The label *babbling* can alert you to trying to hear what may be behind the words, what learners may be trying to express, even though they may not be using terms correctly. So babbling can serve as a trigger for hermeneutic listening. The *didactic tension* (Mason and Davis 1989), which arises from the work of Brousseau (1997), suggests that the more clearly and precisely a teacher specifies the behaviour they want learners to display, the easier it is for learners to display that behaviour without actually generating it for themselves. This explains why hermeneutic listening, ‘teaching by listening’, is so important. It is so easy to fall into ‘training learner behaviour’ rather than providing conditions in which learners ‘educate their awareness’ (Gattegno 1970; Mason 1998). As Towers and Davis (2002, p. 338) write:

These attentive and tentative modes of engagement are offered in contrast to those that frame classroom interaction in terms of causal actions and control – which, once again, we might characterise in terms of a shift from architectural to biological senses of structure. An important element in this manner of pedagogy is its embrace of ambiguity and contingency.

One domain of pedagogic choices that seems not to be mentioned very often has to do with learner involvement in making choices. By getting learners to make significant mathematical choices, and by getting them to construct mathematical objects, exercises and examples, they can push themselves just as much as they feel capable of, rather than depending on the teacher to provide a range of examples suitable for different learners (Watson and Mason 2005). These and other pedagogic strategies could be brought to teachers’ attention more widely, through engaging them in effective personal experiences.

14.3.6 Reasoning, Justification and Proof

‘Proof’ is another aspect of mathematics that is experiencing a revival in mathematics education. But proving things, justifying conjectures by means of mathematical reasoning, is probably not so easily ‘taught’ as enculturated into. When learners discover that they can ‘know things for certain’ in mathematics, not because someone told them so or because they have seen a convincing number of instances to believe it is always true, but because they can reason it out for themselves, their interest and engagement and their disposition towards mathematical thinking can be enriched. Probing learners’ recognition of relationships, in particular, and perception of properties, in general, such as in Molina et al. (2008), Molina and Mason (2009) and Mason et al. (2009), among many others, can enhance sensitivity to which experiences might be useful for learners and hence what pedagogic choices might be effective, concerning the development of their contact with mathematical reasoning. Alerting teachers to pedagogic possibilities for promoting reasoning and for learners becoming aware of their reasoning in the midst of teaching is an ongoing process.

To reason successfully requires awareness of generality, of properties being instantiated rather than simply some relationships holding in some particular situation(s). Only then is it possible to reason making use of previously agreed properties to reach fresh conclusions. But not all reasoning has to be original to the learner: at first, learners can be shepherded towards such reasoning through participation. They can be immersed in such reasoning and invited to engage in such reasoning for themselves. They can also be shown examples of reasoning that is more complex than they might be expected to construct for themselves, so they are immersed in extending and enriching their experience of reasoning. Examples of teachers doing this are always welcome.

14.4 Beyond Whole Numbers

As Bob Davis pointed out (Davis 1984), if children experience the operations of addition over a long period of time, followed only then by subtraction, followed then by multiplication and finally by division, and only then encounter ‘numbers’ that are not whole numbers, it is not surprising that they revert to addition whenever they are faced with a situation in which they do not know what to do. Naturally, they enact the first action that becomes available. If they have learned to park the first action, then they have a chance of probing beneath the surface to find out what is really involved; otherwise, they are likely to disappoint their teachers.

Treating number as a complex whole, incorporating all four operations as early as possible, and drawing on Davydovian ideas by introducing number in the context of units, of some feature being measured, is more likely to lead to an appreciation of arithmetic as the study of properties of numbers rather than as the calculating of answers (Thompson et al. 2014). If they are exposed to scaling as well as repetition, so that multiplication is not identified with repetition, then they have a chance of appreciating and comprehending, if not understanding, the basics of mathematics. Complexity is not best taught through oversimplification, through isolating components and then expecting learners to recompose them into a complex appreciation.

Teachers’ mathematical ‘being’ is manifested moment by moment in the classroom and is picked up subliminally by learners. By participating in mathematical thinking themselves, by enriching and complexifying their sense of mathematical structure, by exhibiting mathematical ‘habits of mind’ (Cuoco et al. 1996), by getting to grips with underlying structures in mathematics such as covariation (Thompson and Carlson 2017) and by enriching the range of pedagogical actions to which they have access, teachers can keep themselves fresh and so provide learners with an immediate and enriching experience from which they can learn. What is needed in the future is evidence for and examples of a truly humane way for humans to teach each other.

References

- Artigue, M. (2011). Challenges in basic mathematics education. Paris: UNESCO. Available from <http://unesdoc.unesco.org/images/0019/001917/191776e.pdf>
- Ball, D. (1993). With an eye on the mathematical horizon: Dilemmas of teaching elementary school mathematics. *Elementary School Journal*, 93(4), 373–397.
- Bednarz, N., Kieran, C., & Lee, L. (1996). *Approaches to algebra: Perspectives for research and teaching*. Dordrecht: Kluwer Academic Publishers.
- Bennett, J. (1966). *The dramatic universe*, 4 vols. London: Routledge.
- Bennett, J. (1993). *Elementary systematics: A tool for understanding wholes*. Santa Fe: Bennett Books.
- Chi, M., & Bassok, M. (1989). Learning from examples via self-explanations. In L. Resnick (Ed.), *Knowing, learning, and instruction: Essays in honor of Robert Glaser* (pp. 251–278). Hillsdale: Lawrence Erlbaum.
- Cuomo, A., Goldenberg, P., & Mark, J. (1996). Habits of mind: An organizing principle for mathematics curricula. *The Journal of Mathematical Behavior*, 15(4), 375–402.
- Davis, R. (1984). *Learning mathematics: The cognitive science approach to mathematics education*. Norwood: Ablex.
- Davis, B. (1996). *Teaching mathematics: Towards a sound alternative*. New York: Ablex.
- Ferrara, F., & Sinclair, N. (2016). An early algebra approach to pattern generalisation: Actualising the virtual through words, gestures and toilet paper. *Educational Studies in Mathematics*, 92(1), 1–19.
- Floyd, A., Burton, L., James, N., & Mason, J. (1981). *EM235: Developing mathematical thinking*. Milton Keynes: The Open University.
- Gattegno, C. (1970). *What we owe children: The subordination of teaching to learning*. London: Routledge & Kegan Paul.
- Gerofsky, S. (1996). A linguistic and narrative view of word problems in mathematics education. *For the Learning of Mathematics*, 16(2), 36–45.
- Greer, B. (1997). Modelling reality in mathematics classrooms: The case of word problems. *Learning and Instruction*, 7(4), 293–307.
- Harvey, R. (2011). Challenging and extending a student teacher's concepts of fractions using an elastic strip. In J. Clark, B. Kissane, J. Mousley, T. Spencer, & M. Thornton (Eds.), *Mathematics: Traditions & [new] practices* (pp. 333–339). Proceedings of AAMT 23 & Merga 34. Adelaide: AAMT and MERGA.
- Kilpatrick, J., Swafford, J., & Findell, B. (Eds.). (2001). *Adding it up: Helping children learn mathematics*. Washington, DC: National Academies Press.
- Kirschner, P., Sweller, J., & Clark, R. (2006). Why minimal guidance during instruction does not work: An analysis of the failure of constructivist, discovery, problem-based, experiential, and inquiry-based teaching. *Educational Psychologist*, 41(2), 75–86.
- Love, E., & Mason, J. (1992). *Teaching mathematics: Action and awareness*. Milton Keynes: The Open University.
- Love, E., & Mason, J. (1995). Telling and asking. In P. Murphy, M. Selinger, J. Bourne, & M. Briggs (Eds.), *Subject learning in the primary curriculum: Issues in English, science, and mathematics* (pp. 252–270). London: Routledge.
- Malara, N., & Navarra, G. (2003). *ArAl project. Arithmetic pathways towards favouring pre-algebraic thinking*. Bologna: Pitagora.
- Mason, J. (1979, February). Which medium, which message. *Visual Education*, pp. 29–33.
- Mason, J. (1988). *Expressing generality* (Project Update). Milton Keynes: The Open University.
- Mason, J. (1996). Expressing generality and roots of algebra. In N. Bednarz, C. Kieran, & L. Lee (Eds.), *Approaches to algebra: Perspectives for research and teaching* (pp. 65–86). Dordrecht: Kluwer Academic Publishers.
- Mason, J. (1998). Enabling teachers to be real teachers: Necessary levels of awareness and structure of attention. *Journal of Mathematics Teacher Education*, 1(3), 243–267.

- Mason, J. (2001a). On the use and abuse of word problems for moving from arithmetic to algebra. In H. Chick, K. Stacey, J. Vincent & J. Vincent (Eds.), *The future of the teaching and learning of algebra* (pp. 430–437). Proceedings of the 12th ICMI study conference, University of Melbourne, Melbourne.
- Mason, J. (2001b). Tunja sequences as examples of employing students' powers to generalize. *Mathematics Teacher*, 94(3), 164–169.
- Mason, J. (2003). Structure of attention in the learning of mathematics. In J. Novotná (Ed.), *Proceedings, international symposium on elementary mathematics teaching* (pp. 9–16). Prague: Charles University.
- Mason, J. (2008). Making use of children's powers to produce algebraic thinking. In J. Kaput, D. Carraher, & M. Blanton (Eds.), *Algebra in the early grades* (pp. 57–94). New York: Lawrence Erlbaum.
- Mason, J., Stephens, M., & Watson, A. (2009). Appreciating mathematical structure for all. *Mathematics Education Research Journal*, 21(2), 10–32.
- Mason, J. (2014). Uniqueness of patterns generated by repetition. *Mathematical Gazette*, 98(541), 1–7.
- Mason, J. (2015). www.prmtheta.com/structured-variation-grids.html
- Mason, J. & Davis, J. (1989). *The inner teacher, the didactic tension, and shifts of attention*. In G. Vergnaud, J. Rogalski, & M. Artigue (Eds.), *Proceedings of PME XIII* (Vol. 2, pp. 274–281). Paris: PME.
- Mason, J., & Johnston-Wilder, S. (2004). *Fundamental constructs in mathematics education*. London: RoutledgeFalmer.
- Mason, J., & Johnston-Wilder, S. (2006). *Designing and using mathematical tasks* (2nd ed.). St. Albans: Tarquin.
- Mason, J., Graham, A., Pimm, D., & Gowar, N. (1985). *Routes to/roots of algebra*. Milton Keynes: The Open University.
- Mason, J. with Johnston-Wilder, S. & Graham, A. (2005). *Developing thinking in algebra*. London: Sage (Paul Chapman).
- Midlands Mathematical Experiment. (1964). London: Harrap. See www.stem.org.uk/elibrary/collection/3612/midlands-mathematical-experiment. Accessed May 2016.
- Molina, M., & Mason, J. (2009). Justifications-on-demand as a device to promote shifts of attention associated with relational thinking in elementary arithmetic. *Canadian Journal for Science, Mathematics and Technology Education*, 9(4), 224–242.
- Molina, M., Castro, E., & Mason, J. (2008). Elementary school students' approaches to solving true/false number sentences. *Revista de Investigación en Didáctica de la Matemática PNA*, 2(2), 75–86.
- Moss, J., & Beatty, R. (2006). Knowledge building in mathematics: Supporting collaborative learning in pattern problems. *International Journal of Computer-Supported Collaborative Learning*, 1(4), 441–465.
- Papic, M., & Mulligan, J. T. (2007). The growth of early mathematical patterning: An intervention study. In J. Watson & K. Beswick (Eds.), *Mathematics: Essential research, essential practice*. Proceedings of the 30th annual conference of the Mathematics Education Research Group of Australasia, Hobart (Vol. 2, pp. 591–600). Adelaide: MERGA.
- Schoenfeld, A. (2014). What makes powerful classrooms, and how can we support teachers in creating them? *Educational Researcher*, 43(8), 404–414.
- Simon, M., & Tzur, R. (2004). Explicating the role of mathematical tasks in conceptual learning: An elaboration of the hypothetical learning trajectory. *Mathematical Thinking and Learning*, 6(2), 91–104.
- Stacey, K. (1989). Finding and using patterns in linear generalising problems. *Educational Studies in Mathematics*, 20(2), 147–164.
- Stacey, K., & MacGregor, M. (1999). Taking the algebraic thinking out of algebra. *Mathematics Education Research Journal*, 11(1), 25–38.

- Stacey, K., & MacGregor, M. (2000). Learning the algebraic method of solving problems. *Journal of Mathematical Behaviour*, 18(2), 149–167.
- Steffe, L., & Kieren, T. (1996). Radical constructivism and mathematics education. *Journal for Research in Mathematics Education*, 25(6), 711–733.
- Tahta, D. (1972). *A Boolean anthology: Selected writings of Mary Boole on mathematics education*. Derby: Association of Teachers of Mathematics.
- Tahta, D. (1981). Some thoughts arising from the new Nicolet films. *Mathematics Teaching*, 94, 25–29.
- Thompson, P., & Carlson, M. (2017). Variation, covariation, and functions: Foundational ways of thinking mathematically. In J. Cai (Ed.), *Compendium for research in mathematics education* (pp. 421–456). Reston: National Council of Teachers of Mathematics.
- Thompson, P., Carlson, M., Byerley, C., & Hatfield, N. (2014). Schemes for thinking with magnitudes: A hypothesis about foundational reasoning abilities in algebra. In K. Moore, L. Steffe, & L. Hatfield (Eds.), *Epistemic algebra students: Emerging models of students' algebraic knowing* (Vol. 4, pp. 1–24). Laramie: University of Wyoming.
- Towers, J. (1998). Telling tales. *Journal of Curriculum Theorizing*, 14(3), 29–35.
- Towers, J., & Davis, B. (2002). Structuring occasions. *Educational Studies in Mathematics*, 49(3), 313–340.
- Towers, J., & Proulx, J. (2013). An enactivist perspective on teaching mathematics: Reconceptualising and expanding teaching actions. *Mathematics Teacher Education and Development*, 15(1), 5–28.
- van Hiele, P. (1986). *Structure and insight: A theory of mathematics education*. London: Academic Press.
- van Hiele-Geldof, D. (1957). The didactics of geometry in the lowest class of secondary school. In D. Fuys, D. Geddes & R. Tichler (Eds.), 1984, *English translation of selected writings of Dina van Hiele-Geldof and Pierre M. Van Hiele*, National Science Foundation, Brooklyn College.
- Verschaffel, L., Greer, B., & de Corte, E. (2000). *Making sense of word problems*. Lisse: Swets & Zeitlinger.
- Watson, A. (2000). Going across the grain: Mathematical generalisation in a group of low attainers. *Nordisk Matematikk Didaktikk (Nordic Studies in Mathematics Education)*, 8(1), 7–22.
- Watson, A., & Mason, J. (2005). *Mathematics as a constructive activity: Students generating examples*. Mahwah: Lawrence Erlbaum.
- Wing, T. (2016). Learning the patter. *Mathematics Teaching*, 251, 14–17.
- Zazkis, R., & Liljedahl, P. (2002). Generalization of patterns: The tension between algebraic thinking and algebraic notation. *Educational Studies in Mathematics*, 49(3), 379–402.

Open Access This chapter is licensed under the terms of the Creative Commons Attribution 4.0 International License (<http://creativecommons.org/licenses/by/4.0/>), which permits use, sharing, adaptation, distribution and reproduction in any medium or format, as long as you give appropriate credit to the original author(s) and the source, provide a link to the Creative Commons license and indicate if changes were made.

The images or other third party material in this chapter are included in the chapter's Creative Commons license, unless indicated otherwise in a credit line to the material. If material is not included in the chapter's Creative Commons license and your intended use is not permitted by statutory regulation or exceeds the permitted use, you will need to obtain permission directly from the copyright holder.







Part III

Panels

Chapter 15

Tradition in Whole Number Arithmetic



Ferdinando Arzarello 
Nadia Azrou , Maria G. Bartolini Bussi ,
Sarah Inés González de Lora Sued , Xu Hua Sun , and Man Keung Siu

15.1 General Introduction

Ferdinando Arzarello

The Merriam-Webster Dictionary¹ defines tradition (Definition 1) as:

- a: an inherited, established, or customary pattern of thought, action, or behavior (such as a religious practice or a social custom);
- b: a belief or story or a body of beliefs or stories relating to the past that are commonly accepted as historical though not verifiable.

The dictionary also states that tradition concerns the ‘handing down of information, beliefs, and customs by word of mouth or by example from one generation to

Electronic Supplementary Material The online version of this chapter (doi:[10.1007/978-3-319-63555-2_15](https://doi.org/10.1007/978-3-319-63555-2_15)) contains supplementary material.

¹<http://www.kamous.com/translator/merriam-webster.asp?book=Dictionary&va=tradition>

F. Arzarello (✉)
University of Turin, Turin, Italy
e-mail: ferdinando.arzarello@unito.it

N. Azrou
University Yahia Fares Medea, Medea, Algeria

M.G. Bartolini Bussi
Department of Education and Humanities, University of Modena and Reggio Emilia,
Modena, Italy

S.I.G. de Lora Sued
Pontificia Universidad Católica Madre y Mestra, Santiago de los Caballeros,
República Dominicana

X.H. Sun
Faculty of Education, University of Macau, Macao, China

M.K. Siu (discussant)
University of Hong Kong, Pokfulam, Hong Kong, China

another without written instruction' (Definition 2) and represents 'cultural continuity in social attitudes, customs, and institutions' (Definition 3).

It is apparent from these definitions that the ways in which whole numbers are spoken, written, thought, taught and learnt sum up what we can address as a part of tradition. Hence, researchers and teachers need to consider these factors from the many different perspectives that make up the multifaceted cultural, epistemological, psychological and neurological nature of tradition.

Some of these components have a more or less strong 'local' connotation because they are linked to different cultures and traditions. However, other components are more general and seem to have universal traits. Hence, the concept of so-called near-universal conventional mathematics (NUC: Barton 2008, p. 10) may conflict with such local instances. This possible contrast can represent a significant problem for teachers because a reasonable learning trajectory for whole numbers cannot avoid discussing their traditional roots, while addressing the NUC as its main goal.

This general background shaped the panel discussions, which aimed to scientifically deepen the analysis of some of these different cultural roots, consider old and new findings from research and practice, and make explicit the main consequences of possible concrete didactical trajectories.

In the following sections, some general issues are considered before introducing the panellists' contributions.

15.1.1 Different Semiotic Representations of Numbers

The historically and culturally different systems of whole number representation encompass a large variety of semiotic systems, including but not limited to language.

15.1.1.1 Numbers and Words

The manner in which numbers are articulated in different languages raises a complex issue that has been examined in a large body of research. From the pioneering book of Menninger (1969) to more recent works (Zaslavsky 1973; Ifrah 1985), all of these studies provide evidence of what Bishop has called the *mathematical enculturation* (Bishop 1991) of numbers (see also Ascher (1991), Selin and D'Ambrosio (2000) and Barwell et al. (2015)).

The manner in which whole numbers are articulated and written is a significant feature that can reveal various different cultural factors. This issue needs to be considered when teaching early arithmetic. Some well-known examples are summarised below (see also, this volume, Chap. 3).

In many languages, the numbers from 11 to 20 are spelled according to specific rules that differ from those for the following sequences, e.g. from 20 to 30. These rules may hide the mathematical structure of those numbers [12 vs 'twelve' (~two left); 14 vs 'quattordici' (~ four-ten); 17 vs 'diciassette' (~ ten-seven)]. Similarly,

the French numbers from 60 to 99 are spelled according to an old base 20 root that is typical of some Celtic languages. For example, to say 97, a French girl/boy must learn to say ‘quatre-vingt-dix-sept’, that is, ‘four (times) – twenty – ten – seven’, whereas a German child must learn ‘Siebenundneunzig’ (seven and ninety) and an Italian child must say ‘novantasette’ (ninety-seven), and so on. In contrast, in Chinese the grammar of numbers is more regular, which may provide an advantage in learning numbers. An Italian teacher, Bruna Villa (2006), has developed an effective learning design for grade one children to teach them how to grasp the machinery of whole numbers (see this volume Sect. 15.3.3). She based her design on what, following Brissiaud, Clerc and Ouzoulias (2002), she called the method of the ‘small Chinese dragon’ (Villa 2006; Electronic Supplementary Material: Arzarello 2017), in which the children articulate numbers based on a uniform Chinese-like structure (e.g. 11 is ‘ten-one’ and not ‘undici’; 21 is two (times) ten-one and not ‘ventuno’) before passing to the Italian system. In this way, she has been able to shorten the time needed to master the whole numbers from one to 100 (in Italian words and standard arithmetic representation) and to use them to carry out arithmetic. In Sect. 15.3.3, this process is illustrated and discussed in more detail.

A further fascinating example, which shows strong differences between the way numbers are spelled in a language and their mathematical structure, is illustrated in Barton (2008), where he discusses the way numbers are articulated in Maori. Prior to European contact, numbers in Maori were similar to verbs in that they expressed actions, e.g. saying that ‘there were two persons’ was similar to saying that ‘those persons two-ed’. This difference was even more dramatic when negation was involved: ‘To negate a verb in Maori the word *kaore* is used. [...] Unlike English, where negating both verbs and adjectives requires the word “not”, in Maori, to negate an adjective a different word is used, *ehara*’ (p. 4). Hence, when this verbal feature of Maori number words was ignored, in English translation the mathematics vocabulary process acted against the original ethos of the Maori language (this volume, Chap. 3).

Other researchers have indicated the ways in which the use of numbers in everyday language interferes with the mathematical meaning of numbers. In an excellent book, unfortunately available only in Italian, a researcher in linguistics, Carla Bazzanella (2011), points out that the expression of numbers in everyday language can convey an indeterminate and largely vague meaning rather than the canonical cardinal denotation (see other examples in this Sect. 15.2.2 and 15.4.2 and in Chaps. 3 and 4 of this volume).

15.1.1.2 Non-verbal Representations of Numbers

Researchers have also discussed the ways in which numbers are represented in different nonlinguistic ways in different cultures (Joseph 2011), e.g. using parts of the body (typically digits, but not only; see Saxe 2014) or spatial arrangements in complex arithmetical calculations when number words are lacking (this volume, Chap. 4).

Many researchers have pointed out that there are some typical steps in the ways in which children progress in building up numbers by intertwining language and gesture, e.g. using their digits for counting and adding. For example, Vergnaud uses an adaptation of the Piagetian notion of the *schème* [which he defines as, ‘the invariant organization of behaviour for a certain class of situations’ (Vergnaud 1997, p. 12)]. He discusses how, when a child uses a counting scheme, a cognitive shift, related to gesture, may occur:

Une autre caractéristique du schème concerne la marque énonciative de la cardinalisation: le dernier mot-nombre prononcé représente le cardinal de tout l’ensemble et non pas le dernier élément. Cette marque énonciative consiste soit dans la répétition (1, 2, 3, 4, 5,... 5), soit dans l’accentuation (1, 2, 3, 4...5). On voit clairement avec ce premier exemple que l’activité langagière est étroitement associée au fonctionnement du schème, et qu’elle prend sa fonction dans un assemblage de gestes perceptivomoteurs dont l’organisation dépend de la disposition des objets et de leur nature, et d’un problème à résoudre: associer un nombre invariant à une collection donnée. (Vergnaud 1991, p. 80)

[Another characteristic of schemes concerns the way cardinalisation is marked in speech: the last number pronounced represents the cardinality of the whole collection and not just the last object. This marking with speech comprises not only the repetition (1, 2, 3, 4, 5,... 5) but also the accentuation (1, 2, 3, 4...5). One can clearly see from this example that language is closely associated with the functioning of a scheme, and that it plays a role in producing perceptuo-motor gestures whose organisation depends on both the nature and arrangement of the objects, and the problem to solve; associating an invariant number with a given collection.]

Butterworth et al. (2011) describe a similar multi-step process for addition strategies that is based on a more neurological stance:

Where two numbers or two disjoint sets, say 3 and 5, are to be added together, in the earliest stage the learner counts all members of the union of the two sets – that is, will count 1, 2, 3, and continue 4, 5, 6, 7, 8, keeping the number of the second set in mind. In a later stage, the learner will ‘count-on’ from the number of the first set, starting with 3 and counting just 4, 5, 6, 7, 8. At a still later stage, the child will count on from the larger of the two numbers, now starting at 5, and counting just 6, 7, 8. It is probably at this stage that addition facts are laid down in long term memory. (p. 631)

Recent studies in ethnomathematics and neurology have introduced a fresh and wider perspective on the issue of language and its role as a resource for arithmetic activities (for a survey from a neuroscientific perspective, see Dehaene and Brannon (2011)). An intriguing example is given in Butterworth et al. (2011), who point out that word counting strategies are not the only methods that people can use for developing arithmetic competencies:

We tested speakers of Warlpiri and Anindilyakwa aged between 4 and 7 years old at two remote sites in the Northern Territory of Australia. These children used spatial strategies extensively, and were significantly more accurate when they did so. English-speaking children used spatial strategies very infrequently, but relied on an enumeration strategy supported by counting words to do the addition task. The main spatial strategy exploited the known visual memory strengths of Indigenous Australians, and involved matching the spatial pattern of the augend set and the addend. These findings suggest that counting words, far from being necessary for exact arithmetic, offer one strategy among others. They also

suggest that spatial models for number do not need to be one-dimensional vectors, as in a mental number line, but can be at least two dimensional. (p. 630)

Further research in neurology has supported these claims in relation to the wider characteristics of mathematics. For example, Varley et al. (2002) show that:

once these resources [mathematical ones] are in place, mathematics can be sustained without the grammatical and lexical resources of the language faculty. As in the case of the relation between grammar and performance on ‘theory-of-mind’ reasoning tasks (42), grammar may thus be seen as a co-opted system that can support the expression of mathematical reasoning, but the possession of grammar neither guarantees nor jeopardizes successful performance on calculation problems. (p. 470)

Monti et al. (2012) also point out that:

Our findings indicate that processing the syntax of language elicits the known substrate of linguistic competence, whereas algebraic operations recruit bilateral parietal brain regions previously implicated in the representation of magnitude. This double dissociation argues against the view that language provides the structure of thought across all cognitive domains. (p. 914)

Finally, some studies have pointed out that the sense of numbers is not only based on discrete approaches that rely on the one-one correspondence between external symbols and numerical representations, but also on approximate number of systems (e.g. the estimation of the numbers of two sets when subitising is not possible) that are based on the ratio between their cardinality and not on their difference (see Gallistel and Gelman (2000)). According to these studies, this continuous, analogic system emerged during our evolution and became encoded in our brains prior to the discrete approach.

These findings have introduced a fresh perspective on the issues of tradition and language and their roles as resources for arithmetic activities.

In particular, some major questions for the panel are:

- How can teachers base their task designs for arithmetic on the linguistic and cultural roots of numbers?
- Does the embodied traditional approach to arithmetic need to be modified/extended by the findings of the neurological research on numbers?

15.1.1.3 Representing Numbers in Artefacts

In the research on the semiotic representation of numbers, a specific stream of analysis concerns the calculation tools (typically, but not only, abaci) that incorporate both the specific representations of numbers and the corresponding practices for completing arithmetical operations (for a survey see Ifrah 2001). These tools are deeply intertwined with language and can be incorporated in the didactical designs used in primary school. Many teachers use the tools alongside modern technology to introduce concrete artefacts and their simulations in a virtual technological classroom environment. For example, Sinclair and Metzuyanin (2014) integrated such embodied and traditional representations using tablets based on the hypothesis that

the touch-screen devices enable an intuitive, embodied interface for conducting arithmetic. The devices are also suitable for young learners because they allow them to use their fingers and gestures to explore mathematics ideas and express mathematical understandings. Furthermore, Soury-Lavergne and Maschietto (2015) use an old Pascal machine to approach arithmetic in concrete and virtual ways in primary school. These and further examples are discussed in Chap. 9 of this volume.

These types of research pose the following interesting questions for the panel:

- How are traditional instances embodied in the current technology?
- Does the possible integration of cultural roots within a technological environment allow the gap between the ‘old-fashioned’ tradition and the NUC to be bridged?

The panel consists of four scholars² who are representative of the different cultural traditions of teaching numbers, namely, Nadia Azrou (mathematics teacher at the University of Yahia Fares in Medea, Algeria, and a PhD student in math education), Maria G. Bartolini Bussi (full professor in mathematics education at the University of Modena and Reggio Emilia, Italy), Sarah Inés González de Lora Sued (full professor in mathematics education at Pontificia Universidad Católica Madre y Maestra, República Dominicana) and Xu Hua Sun (assistant professor in education at the University of Macau, China). Man Keung Siu (honorary fellow, The University of Hong Kong) acted as the discussant.

15.2 Spoken and Written Arithmetic in Different Languages: The Case of Algeria

Nadia Azrou

15.2.1 *Post-colonial Countries: The Case of Algeria*

At the elementary level, numbers are learnt along with several technical concepts (e.g. the place value of digits, number line and decimal position system) that support learning or weaken it if not effectively acquired. Learning numbers and other basic arithmetic notions is also affected by culture and particularly by language. This is more visible in multicultural classes in schools that host migrants of different nationalities, but also in post-colonial countries such as Algeria, where history, cultural evolution and external and internal power influences have a direct influence on the school system.

²Sarah Inés González de Lora Sued was unable to take part in the panel for health reasons. However, she provided a text, which appears in this chapter.

How do we deal with such phenomena? The globalisation of school mathematics, which aims to unify the curricula in countries that have different cultural and linguistic backgrounds, and the assumption that learners have to submit to a country's dominant language, have been shown to have their limitations. From a different perspective, Usiskin (1992) claims that differences provide the best situation for curriculum development and implementation. Gorgorió and Planas (2001) point out that if language is the main carrier of a culture, then the 'language of the mathematics class' conveys the culture of the classroom as a social group doing mathematics, along with its norms and legitimate roles.

For teachers, this clearly represents a challenge, particularly for those who teach in a traditional, transmissible way. Most teachers presume that the 'normal' learning context is a monolingual classroom, that learners know the 'norms' of the school (which are usually shaped by the dominant culture) and that children already master the language of instruction. Given this situation, teachers should acknowledge the relevance of the issues related to cultural and linguistic diversity, understand how they influence the learning process and manage them to scaffold the children's learning in an effective way. In particular, teachers should be able to identify the possible difficulties that children experience when learning numbers in a language different from their mother tongue and to create opportunities to turn these difficulties into advantages. Moreover, I share the view of Gorgorió and Planas (2001) who believe that there is no classroom in which linguistic capital is equitably distributed. As a consequence, what may appear as an extremely 'different' setting not relevant for mainstream practice may be relevant for communication issues in all classrooms.

Further research is needed to clarify how mathematical language can be taught and to investigate the relationships among the 'language of the mathematics class', mathematical language and the process of construction of mathematical knowledge (Gorgorió and Planas, 2001). However, some elements and insights can already be provided to address the question of how teachers can concretely develop their task designs for basic notions of arithmetic by taking the linguistic characteristics and cultural roots of numbers into account. Some answers may be suggested by the analysis of the situation.

15.2.2 Number Naming, Place Value and Decimal Position System

It is not unusual for a language to have irregularities in regard to number naming, and these irregularities are not the same in different languages. In Europe, for instance, every language possesses its own number naming system with its own set of irregularities. For example, similar to French, Spanish and Italian, the numbers between 13 and 19 in English have names that position the lowest place value digit first, in contradiction to the written form, which goes from left to right according to

the decreasing place value of digits and the other spoken numbers. Moreover, although in English the word ‘ten’ is nearly present in thirteen (13) to nineteen (19) as in Italian, this is not the case in French where ‘ten’ (‘dix’) does not appear in the numbers 12 to 16 (e.g. quatorze 14, seize 16), although 17 is pronounced ‘dix-sept’). In Arabic, the numbers from 11 to 99 are pronounced from the lowest place value digit to the highest and are in complete correspondence with the written form, which is presented from right to left. In Danish, seventy is named halvfjerds, which is a short for halvfjerd-sinds-tyve, meaning “fourth half times twenty”, or “three score plus half of the fourth score” [$3\frac{1}{2} * 20$]. Moreover, as in German, there is no correspondence between the written and spoken forms for the numbers from 13 to 99, which are pronounced from the lowest place value digit to the highest. In French, the numbers between 81 and 99 are expressed as ‘four-twenty’ plus a number between 1 and 19. Traces of the contamination between different languages and the historical roots in old number systems can be detected in these irregularities and differences. However, irregularities, in the same oral language or when shifting from one language to another, may be a source of difficulty for children. Research suggests that in some Asian countries, Asian speaking children perform better with place value, counting and decimal system tasks due to their regular number naming systems (Miura et al. 1994). Nonetheless, irregularities and differences also provide students (under the guidance of the teacher) with opportunities to notice important characteristics of the decimal position system of writing of numbers, such as the position value of digits and reflect on them. For instance, with reference to the above examples, the teacher may exploit the differences between the irregular forms of spoken numbers within the same language (in the case of most European languages) and between how numbers are spoken in one language and another.

The case of Algeria is interesting. About 10 years ago, a political decision was made to write formulas and symbols from left to right with the Latin alphabet (in the past they were written from right to left with the Arabic alphabet) when teaching mathematics at all levels, while maintaining comments and names in classical Arabic (from right to left). This change has subsequently influenced how children conceive, understand and learn arithmetic. Thus, teachers should use this as an opportunity to allow children to realise that mathematics is not separate from culture and language and to understand that its evolution is also affected by the historical and political dynamics.

15.2.3 Mathematics Register

As defined by Halliday & Hasan (1985), the mathematical register records how everyday language is used in new ways to serve the meanings of mathematical words, even though words such as ‘double, less, more’ may have different meanings in ordinary language from those in mathematics. These differences may have resulted in some children failing to solve problems caused by misunderstanding the text. For example, in Arabic, the verb used to express the multiplication operation is

to ‘beat’ (thus scaring the children), that is, ‘we multiply 2 by 4’ is ‘we beat 2 to 4’. In English, expressions such as ‘twice as much as’ or ‘twice as less as’ may sound ambiguous. Accordingly, children need to learn the language patterns associated with these words, how to construct concepts in mathematics and the implicit logical relationships, because when children construct mathematics concepts in everyday language, the relationships they come up with are often technically incorrect. Learning mathematics and the language of mathematics, that is, the mathematics register, is a challenge for all children. Teachers can facilitate the learning process by using the mathematical register effectively and working to build language in deliberate ways, moving from everyday to technical linguistic expressions of mathematical knowledge and using spoken language, reading and writing. If learners have difficulties in verbalising a mathematical process, the teacher can promote mathematical thinking by using their mother language to tackle mathematical problems (Adler 1997). Thus, it is highly recommended that teachers have some knowledge about their learners’ languages and consider the norms and contexts in which words are used. Teachers should aim to develop the mathematics register in the languages in which the children are instructed. However, until this is done, teachers need to face and overcome the difficulties in translating mathematics concepts into students’ home languages (Schleppegrell 2007).

15.3 From the Number Line to the Productive Dialogue Between Different Cultural Traditions: Italy and China

Maria G. Bartolini Bussi

15.3.1 The Number Line

The number line is a very popular teaching aid (Bartolini Bussi 2015; Electronic Supplementary Material: Bartolini Bussi 2017). Italian teachers can find specific references to the number line in the standards (MIUR 2012) for the mathematics curriculum. To begin with, the number line comprises whole numbers and it is then expanded to contain rational numbers. The following goals are stated at the end of the third grade (the first time the goals are explicitly listed):

To read and write whole numbers in base ten, being aware of the place value; to compare and to order them, representing them on the number line. (p. 61)

To read, write and compare decimal numbers, to represent them on the number line (p. 61)

The goals are summarised and reinforced at the end of primary school (fifth grade):

To represent the known numbers on the line and to use graduated scales in contexts that are meaningful for science and technique. (p. 62)

The last goal hints at a possible use of the number line as a modelling tool. A similar use is stated in the history curriculum, where, at the end of primary school (fifth grade), the following goal is stated:

To use the timeline to organize information, pieces of knowledge, periods and to detect sequences of events, concurrent events, duration of events. (p. 53)

The representation of numbers on a line is emphasised (at all levels) in the framework for the national assessment in mathematics (INVALSI 2012).

The general approach to the mathematics curriculum in Italy is stated in the programmes (MIUR 1985) for primary school:

The development of the concept of whole numbers must be roused exploiting the previous experience of students, like counting and recognizing numerical symbols in play and in family and social life. It is advisable to consider that the idea of whole number is complex and requires a multifaceted approach (order, cardinality, measuring, ...); it is acquired at higher and higher levels of internalisation and abstraction during primary school and beyond.

This idea is widely shared and has been confirmed in other curriculum documents (e.g. MIUR-UMI 2001), which have strongly influenced the elaboration of the more recent standards (e.g. MIUR 2012).

In the number line, order and measuring are in the foreground. However, the other properties of whole numbers (e.g. cardinality, place value representation) are not supported by the number line and must be taught independently. This choice is consistent with a multifaceted approach in which different routes are explored in parallel to develop a complex concept of whole numbers.

In contrast, as argued by Sun (2015), the Chinese tradition of whole number arithmetic appears to place less emphasis on the number line and to foreground other properties of whole numbers (e.g. the part-part-whole and associative law) in constructing a consistent teaching path in which these properties are pursued in a systematic way, step by step and without deflection.

15.3.2 The Dialogue Between Cultures: Towards Cultural Transposition

The panel discussion on the number line is a paradigmatic example of the process that occurs when scholars from different cultural backgrounds engage in a true dialogue. The point is not to determine the best, ‘universal’ choice but to understand how and why the mathematics curriculum was developed in one’s own context. Jullien (1996) stated that, ‘every thought, when coming towards the other, questions itself about its own unthought’ (p. iii). In this sense, noticing the different approaches used in Italy and China serves as a prompt to start a cultural analysis of the content (Boero and Guala 2008). Cultural artefacts, when carefully analysed, reveal a lot of things about the culture that has produced them. To implement activities by using

cultural artefacts in a different culture, it is necessary to enter a process of *cultural transposition*, where:

the different cultural backgrounds generate possibilities of meaning and of mathematics education perspectives, that, in turn, organize the contexts and school mathematics practices in different ways. (Mellone and Ramploud 2015, p. 578)

15.3.3 Examples of Cultural Transposition

The first example concerns the use of counting rods for the development of place value. Some years ago, we analysed some Chinese textbooks for the first grade and noticed the use of counting rods and bundles of rods to link numbers and quantities. The book for the first semester of the first grade comprised 120 pages (from September 1 to the end of January). After having presented the numbers from 1 to 10 together with addition, subtraction and word problems, the numbers between 10 and 20 were introduced. On p. 85, the following activity was presented (Fig. 15.1). This was the first activity in which numbers with two digits (from 11) were introduced.

The teacher says: ‘First count ten little rods and bind them to get one bundle. How can you go on counting?’ The boy answers: ‘To combine together one ten and one, it is ten-one’. The right classifier is always used: \uparrow (*gè*) for rods and 捆(*kǔn*) for bundles; \uparrow (*gè*) again for one and for ten, which is the origin of place value (this volume, Chap. 3).

The process is supposed to be very fast, as if the student is able to produce the right name without any help from the teacher. This natural process is possible in China, because the way of recognising numbers in Chinese is part of everyday experience and completely transparent in relation to the place value (this volume, Chap. 3). No specific teaching processes are needed in school. In contrast, a specific teaching process is needed to design school practices in other languages/cultures. For instance, the names of numbers in Italian are irregular and not transparent, and hence it is not possible for a student to name a number with one bundle and one rod (‘undici’ in Italian, ‘eleven’ in English). It is necessary to plan two parallel processes before linking the rod and bundle representations to the names and the symbols in which the bundles are bound to construct the concept of ten as a higher order unit, and the Italian names for the numbers are learnt. Only later is it possible to link these processes to one another. Thus, more instruction time is needed than in the Chinese classroom.

An Italian teacher, Bruna Villa, produced another example of cultural transposition in the same content (see this chapter Sect. 15.1.1.1; Electronic Supplementary Material: Arzarello 2017). She also introduced two parallel processes. At the beginning of the first grade, the teacher told a fairy tale of a small Chinese dragon who was visiting the classroom to teach the children how to say numbers. Hence, the students learnt to say the numbers in two ways:



Fig. 15.1 The introduction of tens in the Chinese textbook (Mathematics Textbook Developer Group for Elementary School, 2005)

The completely regular Chinese-like names: 11 is ten-one; 21 is two ten-one.

The Italian irregular names: 11 is 'undici', that is, 'eleven'; 21 is 'ventuno', that is, 'twentyone'.

The teacher evoked the images of two imaginary characters, the 'small Chinese dragon' (with narratives, drawings and even hats to wear when acting as a dragon) and the 'mom', representing the (Italian) adult voice from the students' everyday experience, for some months to avoid ambiguity and help the students to make sense of the experience. In this way, the teacher succeeded in teaching place value in an exciting but robust way while introducing some ideas about different cultural contexts.

Another example concerns the planned transposition to Italian classrooms of the word problem of cakes observed in the first grade of the Hou Kong School (this volume, Chap. 11). In this case, the task draws on Chinese practice to consider a number as a system of part-part-wholes in different ways (a variation of the 'one problem, multiple solutions' (OPMS) approach, Sun (2011)). Italian students are not accustomed to these kinds of tasks, hence the cultural transposition to Italian classes requires additional tasks to be introduced in parallel to the existing ones.

There are other examples of variation problems (e.g. Bartolini Bussi et al. 2013). After being examined in pilot studies, some curriculum material has been developed in Italy (see the Italian project *PerContare*, this volume, Chap. 7) in which the cultural analysis has been made explicit for teachers. This is a possible answer to the last question posed to the panel, namely, where do the 'traditional' activities of dif-

ferent cultural traditions come from? We were able to exploit the cultural transposition because the Italian standards leave some freedom for teachers to conduct pilot experiments. My questions are now: Is it possible to conduct pilot experiments in China that exploit new activities? And how can cultural differences be incorporated into the established approach, which is mainly based on textbooks with fixed content for each lesson?

15.4 The Role of Using the Cultural Roots of Numbers and Artefacts for Children Learning Whole Number Arithmetic in Latin America

Sarah Inés González de Lora Sued

15.4.1 The Design of Learning Tasks for Arithmetic Based on the Linguistic and Cultural Roots of Numbers

Most of the time, whole number arithmetic learning is not related to the reality in which children live, because the design of the learning tasks is divorced from the local cultural environment. Referring to the weak relationship between culture and mathematics in the classrooms, D'Ambrosio (2001) stated that:

when teachers do acknowledge a connection between mathematics and culture often they engage their students in multicultural activities merely as a curiosity. Such activities usually refer to a culture's past and to cultures that are very remote from that of the children in the class. (p. 308)

And he also pointed out:

As our students experience multicultural mathematical activities that reflect the knowledge and behaviors of people from diverse cultural environments, they not only may learn to value the mathematics but, just as important, may develop a greater respect for those who are different from themselves. (p. 308)

However, when mathematics, and whole number arithmetic in particular, is presented to students using examples that are a lively part of their culture (e.g. by introducing mathematical concepts and procedures through problematic situations drawn from their reality), the concepts become meaningful to them.

D'Ambrosio stresses that:

We can help students realize their full mathematical potential by acknowledging the importance of culture to the identity of the child and how culture affects how children think and learn. We must teach children to value diversity in the mathematics classroom and to understand both the influence that culture has on mathematics and how this influence results in different ways in which mathematics is used and communicated. We gain such an understanding through the study of Ethnomathematics. (p. 308)

Moreover, if whole number arithmetic is taught in isolation from the culture of segregated populations, such as the many indigenous populations of Latin America, the situation becomes more complex. In the 2013 report ‘Intercultural citizenship: Contributions from the political participation of indigenous peoples in Latin America’, the United Nations Development Programme (UNDP) indicated that there are approximately 50 million indigenous people in Latin America, about 10% of the total population. However, in countries such as Peru and Guatemala, indigenous people account for almost half of population, while in Bolivia they comprise over 60% of the total population. These indigenous peoples speak their own languages and many are marginalised because they do not speak Spanish. These cultures also have their own ways of conceptualising whole numbers. Many studies have been conducted on the mathematics of indigenous Latin American cultures. To teach the children of these populations, teachers need to be able to understand these mathematical approaches to whole number arithmetic. In the case of Guatemala, by law, all children must be taught using the Mayan number system *and* the base 10 system.

15.4.2 Numbers and Words

Table 15.1 lists the names of the numbers from 1 to 20 in Mayan, Quechua Collao and Spanish. The fourth column lists the Latin words from where the Spanish names proceed, according to the Real Academy of the Spanish Language. It is interesting to note the patterns in the table. For example, from 1 to 10, the names within each language do not have any relationships among them. For Mayan numbers, this is also the case for numbers 11 and 12. However, from 13 to 19, the names are composite words of the names 3 to 9 and the name of 10 (lahun). In the case of Quechua Collao, from 11 to 19, the names are composite words with the name of 10, ‘Chunka’, the names of the numbers from 1 to 9 and the word ‘niyuk’. In this case, the word for 10 comes first. In the case of Spanish names, from 11 to 15, the relationships between the names and the numbers are not clear. However, when you see the Latin roots of the words, as described in the dictionary of the Real Academy of Spanish Language, it seems the meaning is ‘one and ten’ for 11, ‘two and ten’ for 12, and so on. The dictionary of the Real Academy of Spanish Language does not include the roots of numbers 16 to 19 but their meaning is clearer and easier for children to understand (ten and six, ten and seven, and so on).

Moreover, in Quechua Callao, 30 is kimsa chunka, 40 tawa chunka, 50 pichqa chunka and so on, which can be interpreted as having the multiplicative meanings of three times ten, four times ten and so on. In Spanish, 30 is treinta and its Latin root is triginta, 40 is cuarenta and its Latin root is quadraginta, 50 is cincuenta and its Latin root is quinquaginta and so on with the same meaning. It seems that it would be easier for Quechua Collao children to learn the names of numbers from the patterns of the names.

Table 15.1 Some pre-Columbian names of numbers

	Mayan names of numbers	Quechua Collao	Spanish	Latin root
1	<i>Hun</i>	<i>Huk</i>	<i>Uno</i>	<i>Unus</i>
2	<i>Caa</i>	<i>Iskay</i>	<i>Dos</i>	<i>Duo</i>
3	<i>Ox</i>	<i>Kimsa</i>	<i>Tres</i>	<i>Tres</i>
4	<i>Can</i>	<i>Tawa</i>	<i>Cuatro</i>	<i>Quattuor</i>
5	<i>Hoo</i>	<i>Pichqa</i>	<i>Cinco</i>	<i>Quinque</i>
6	<i>Uac</i>	<i>Suqta</i>	<i>Seis</i>	<i>Sex</i>
7	<i>Uuc</i>	<i>Qanchis</i>	<i>Siete</i>	<i>Septem</i>
8	<i>Uaxac</i>	<i>Pusaq</i>	<i>Ocho</i>	<i>Octo</i>
9	<i>Bolon</i>	<i>Isqun</i>	<i>Nueve</i>	<i>Novem</i>
10	<i>Lahun</i>	<i>Chunka</i>	<i>Diez</i>	<i>Decem</i>
11	<i>Buluc</i>	<i>Chunka hukniyuq</i>	<i>Once</i>	<i>Undecim</i>
12	<i>Lahca</i>	<i>Chunka iskayniyuk</i>	<i>Doce</i>	<i>Duodecim</i>
13	<i>Oxlahun</i>	<i>Chunka kimsaniyuk</i>	<i>Trece</i>	<i>Tredecim</i>
14	<i>Canlahun</i>	<i>Chunka tawaniyuk</i>	<i>Catorce</i>	<i>Quattuordecim</i>
15	<i>Hoolahun</i>	<i>Chunka pichqaniyuk</i>	<i>Quince</i>	<i>Quindecim</i>
16	<i>Uaclahun</i>	<i>Chunka suqtaniyuk</i>	<i>Dieciseis</i>	
17	<i>Uuclahun</i>	<i>Chunka qanchisniyuk</i>	<i>Diecisiete</i>	
18	<i>Uaxaclahun</i>	<i>Chunka pusaqniyuk</i>	<i>Dieciocho</i>	
19	<i>Bolonlahun</i>	<i>Chunka isqunniyuk</i>	<i>Diecinueve</i>	
20	<i>Hun Kal</i>	<i>Iskay chunka</i>	<i>Veinte</i>	<i>Viginti</i>

15.4.3 *The Role of Semiotic Representation in Learning Whole Number Arithmetic*

Radford (2014) discussed the influence of representation and artefacts on knowing and learning, indicating that:

the problem of the epistemic and cognitive role of tools and signs continues to haunt us—perhaps now more than ever by virtue of the unprecedented technological dimensions of contemporary life. And so here we are still trying to make sense of how we think and learn with and through signs and artefacts. We assume that interaction with reality plays a crucial role in learning. Meanings constructed from one’s experience lead to a deeper understanding of theoretical constructions. From this perspective, human perception and action and, more generally, interaction with artefacts, are of crucial importance for learning and doing mathematics. (p. 406)

Arzarello et al. (2005) pointed out:

The embodied point of view of our ‘acting is learning’ stresses the importance of relating action and language to mental activity. Although such a claim is widely acknowledged from a theoretical point of view, our provocation consists in fostering its transposition in school practice. (p. 56)

In the Dominican Republic, for example, the use of concrete manipulatives, such as base-ten blocks and Cuisenaire rods, for learning whole numbers was only

introduced in public schools around two decades ago (85% of schools in the country). This approach has been shown to motivate students and teachers to represent number concepts and operations and has produced higher levels of achievement when accompanied with teachers' professional development activities (González et al. 2015). In the case of Peruvian indigenous children, the use of the Yupana, an artefact used by the quipucamayos (accounting people in the Inca Empire), is more appropriate because it is grounded in their culture. There are several hypotheses with respect to how the Yupana was used by the Incas. Based on the hypothesis of William Burns, in the 1980s Martha Villavicencio Ubillús (1990) developed a methodological sequence for the comprehensive learning of the decimal numeration system and the algorithms of the basic operations using the Yupana, which was first applied in the bilingual education experimental project of the Puno and is now used widely in bilingual schools in Perú. There are also technological applications for children to simulate arithmetic operations using the Yupana through computers, cellphones and tablets (Rojas-Gamarra and Stepanova 2015).

15.5 Chinese Arithmetic Tradition and Its Influence on the Current Curriculum³

Xu Hua Sun

15.5.1 Chinese Arithmetic Tradition

The ancient Chinese called mathematics arithmetic (算術 an art of computation), which possibly reflects China's long history and tradition of arithmetic. It is interesting to note that the Chinese traditional approach to whole numbers was mainly cardinal rather than ordinal. Ordinal numbers are formed by adding 第 *dì* ('sequence') before the number. The Chinese use cardinal numbers in certain situations in which English and other Western languages use ordinals. For example, whereas a person lives on the fourth floor in a building in English, in Chinese, it is said the person lives on four floor, not the fourth floor. In Chinese, the 20th of July is expressed as 20 July.

Figure 15.2 shows the world's earliest decimal multiplication table. Made from bamboo slips, the table dates from 305 BCE, during the Warring States period in China. Place value is the most overarching principle used in Chinese numerals and calculation tools (counting rods and the Chinese abacus), which could provide advantages as a regular system (foundation) for whole arithmetic/algebra development.

³This study was supported by Research Committee, University of Macau, Macao, China (MYRG2015-00203-FED). The opinions expressed in the article are those of the author.

Fig. 15.2 The world's earliest decimal multiplication table

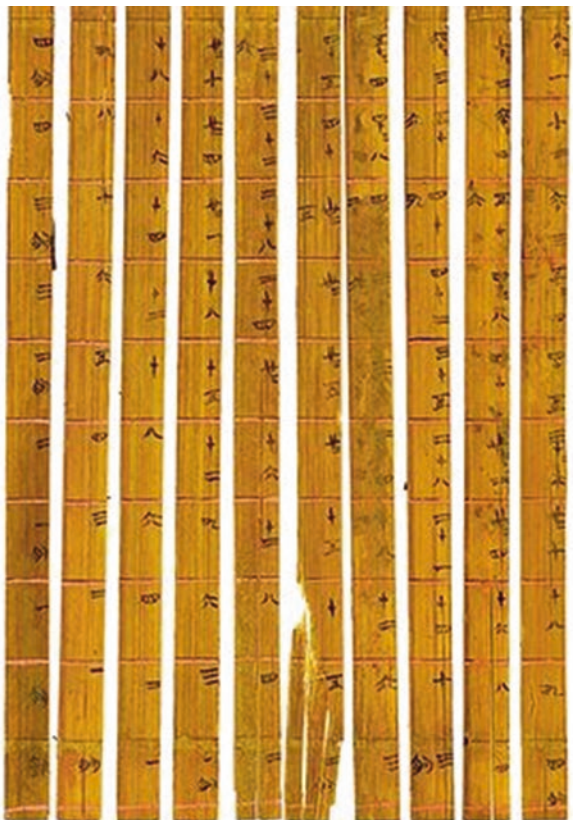

The Chinese term for mathematics is *shuxue* (數學) or *suanxue* (算學), which mean research on number or computation. Geometry was not included in the Chinese mathematics school curriculum until Euclid's *Elements* was introduced in the seventeenth century by Matteo Ricci (1552–1610) and Guangqi Xu (徐光啟). The *Elements* mirrored the Chinese calculation tradition and was derived from the local world view. The ancient Chinese believed that the only way of knowing the world is through calculation, which is reflected in the *I Ching* (易經) in general. This is also expressed in the following quotation from the preface of *Sunzi Suanjing* (孫子算經):

Calculation is the whole of heaven and earth, the origins of all life, the beginning and end of all laws, father and mother of yin-yang, the beginning of all stars, the inner and outer of three lights, the standards of five elements, the beginning of four seasons, the origins of ten thousands matters, and the general principles of six arts. (Lam and Ang 2004, p. 29)

Shushu Jiayi (數術記遺) (the first Chinese book – 220 CE – about calculation and its tools) systematically recorded 14 calculation approaches and 13 calculation tools. Among them, only bead calculation and base two (related to the computer) calculation have been handed down to today. All mathematics books are based on the decimal place number system, in which place value is the most overarching principle used in Chinese numerals and calculation tools (this volume, Chap. 3).

15.5.2 The Chinese Arithmetic Curriculum

Chinese mathematics education is famous for its stable basic education (Zhang 2006). The number line is rarely used in the Chinese curriculum, which may reflect some cultural trends in understanding number in China (Sun 2015).

The cardinal approach to whole numbers is embedded in the *suàn pán* (算盤, this volume, Chap. 9). The current Chinese curriculum standards mention *suàn pán* as a traditional tool for representing place value.⁴ Bead calculation is not required, although some books for students are available. However, the spike abacus (which is similar to the *suàn pán*) is widely used in the current curriculum as a heritage item (Fig. 15.3).

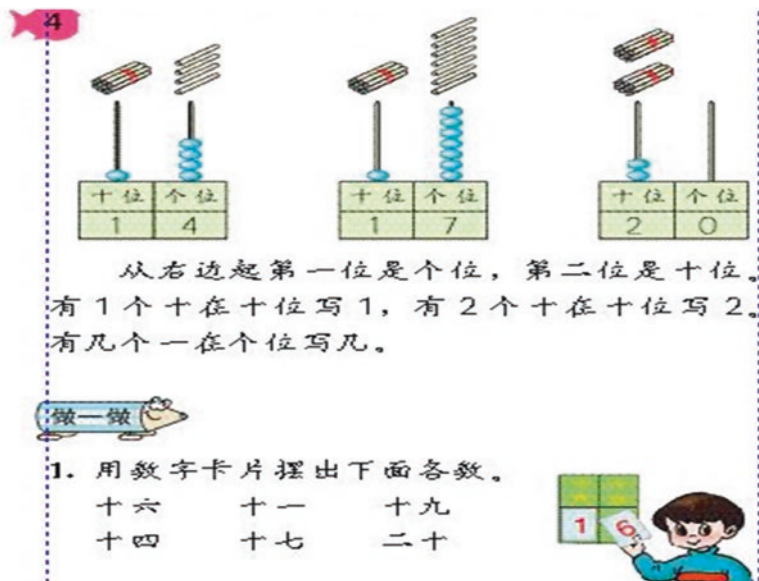

Fig. 15.3 Spike abacus with rods in a Chinese textbook (Mathematics Textbook Developer Group for Elementary School, 2005)

⁴http://www.pep.com.cn/xxsx/jszx/xskcbj/201202/t20120224_1103348.htm

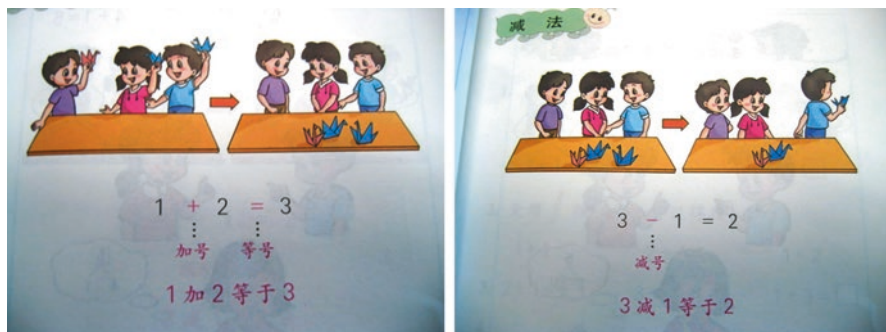

Fig. 15.4 Addition and subtraction with concept connection in a Chinese textbook (Mathematics Textbook Developer Group for Elementary School, 2005, vol. 1)

It is worth noting that the Chinese curriculum aims to develop a system of numerative reasoning at an early stage. In addition to being closely related, implicit connections are made between the three concepts of addition, subtraction and number and the inverse relation between addition and subtraction ($a - b = c$ equals $a = b + c$). The authors of Chinese textbooks link the concept of subtraction to that of addition even in the first calculation lesson (Sun 2011). Figure 15.4 shows the paradigmatic example of $1 + 2 = 3$, $3 - 1 = 2$ (Mathematics Textbook Developer Group for Elementary School 2005, pp. 20–21). The aim of the problem is to help learners understand the relationship between addition and subtraction and the meaning of ‘equal’. The prototypical example from the Chinese textbook is an example of a *variation problem*. Further details of variation problems can be found in this volume (Chap. 11).

Chinese curriculum developers have connected the three core concepts of addition, subtraction and number in all of the chapters on addition and subtraction using the following explicit principles:

1. Adding one into a number obtains its adjacent number.
2. Subtracting one from the adjacent number gives the original number again.

This approach not only promotes rote counting and memorising but also reasoning. In contrast, in many Western curricula, the ideas of number, addition and subtraction are presented in separate chapters, isolated from one another.

Drawing on $1 + 2 = 3$; $3 - 1 = 2$ (Fig. 15.4), Chinese curriculum designers also aim to elicit a similar property for tens and thousands (Fig. 15.5).

$1\text{ten} + 2\text{tens} = 3\text{tens}$; $3\text{tens} - 1\text{ten} = 2\text{tens}$.

$1\text{thousand} + 2\text{thousands} = 3\text{thousands}$; $3\text{thousands} - 1\text{thousand} = 2\text{thousands}$.

This kind of inductive generalisation is widely used in the Chinese curriculum (Sun 2016a, b) and represents a further example of the variation problem from units to tens to thousands (Mathematics Textbook Developer Group for Elementary School 2005).

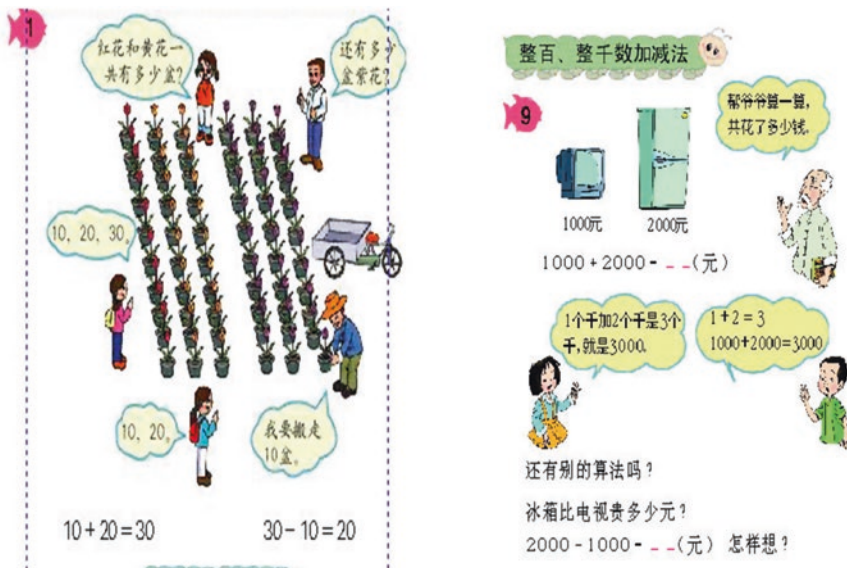

Fig. 15.5 From units to tens (the left) and thousands (the right) in the Chinese textbook (Mathematics Textbook Developer Group for Elementary School, 2005)

The Chinese curriculum for teaching number avoids counting as much as possible and is, therefore, different from the Western style of number teaching. The curriculum highlights the approach of composition/decomposition, which may have been inherited from ancient bead calculation. The approach is used seven times with 1–10 (decomposition of 4, 5, 6, 7, 8, 9, 10 in 7 lessons) in the Chinese curriculum (Sun 2013), which implicitly forms a core practice for learning number (Sun 2015). This approach aims to develop an implicit understanding of the associative and commutative laws, number properties and foundation of addition/subtraction operational flexibility. The partitions of ten are intensely studied, and numbers such as 12 are thought of from the beginning as one ten and two ones. The number names in Chinese are consistent with this method (for details see Chap. 3). The emphasis on partitioning and regrouping lends itself naturally to written algorithms.

The speed and accuracy of oral calculation are important requirements in the assessment of the Chinese curriculum standards. Great importance is traditionally attached to calculation because whole number is considered to be ‘the first foundation of the whole subject’ (Elementary Mathematics Department 2005, p. 1). This statement is consistent with the current Chinese curriculum standards, which state that:

Oral calculation is the basis for learning mathematics. It should have very important influence on students’ basic written calculation capacity. Its training can help students develop capability of observation, capability of comprehensive thinking, capability of creativity, and capability of reaction.

This heavy emphasis on calculation skills is reflected in the higher requirements for speed and accuracy in oral (mental) and paper-and-pencil calculations. For example, addition and subtraction between 1 and 20 should be completed at 8–10 operations per minute and from 20–100 at 3–4 per minute, whereas multiplication within 1–10 should be conducted as a rate of 3–4 per minute and two-digit multiplication at 1–2 per minute, all with 90% accuracy.

Chinese mathematics evolved in relation to the problems of land measurement, commercial trade, architecture, government records and taxes. The systematic word problems in the current curriculum include simple and complex problems called variation problems. These problems aim to deepen the concept connections and operations and increase flexibility (举一反三) (e.g. Bartolini Bussi et al. 2013; Sun 2011, 2016a, b). Further discussion of the variation problem can be found in Chap. 11.

15.5.3 Concluding Remarks

This brief presentation has highlighted the significant differences between the Chinese and Western curricula (in the USA and Europe) inherited from tradition. Further details on this topic can be found in this volume (Chap. 3). The aim of this contribution is to start a dialogue between cultures. Bartolini Bussi, Sun and Ramploud (2013) have argued that the goal of a true dialogue between scholars with different cultural backgrounds is not to determine the best ‘universal’ choice but to understand the development of one’s own mathematics curriculum, which is helpful for questioning the unthought characteristics of the educational context.

15.6 Discussion

Man Keung Siu

15.6.1 Introduction

Most of the speakers on this panel have talked about the linguistic and cultural characteristics of the topic. As a mathematician, I will try to supplement the discussion by focusing more on the mathematical context. First, let me sketch a general framework of the teaching and learning of mathematics.

We begin with a world ‘without mathematics’. This statement is to be taken with a grain of salt because mathematics is everywhere in our world and comes up frequently and unavoidably in our daily lives, perhaps even without our noticing it. You would know what I mean by that if you put yourself in the shoes of an infant who

knows no ‘formal mathematics’. Later, we come to see the world after learning some elementary mathematics and forming the ideas of mathematical objects, notions, theories and techniques. Then we come to understand more ‘formal’ mathematical concepts as we refine our ideas of these mathematical objects, notions, theories and techniques. This is what Bill Barton labels NUC (near-universal conventional) mathematics (see also Sect. 15.1.1.1). Finally, we try to apply the mathematics we have acquired to solve different kinds of problems. In some senses, NUC is culturally independent. However, when teaching mathematics, cultural transposition (as discussed in Sect. 15.3.2) is also a helpful concept.

Relatively few basic concepts are learnt in primary and secondary school, and these basic concepts come up time and again throughout a child’s primary, secondary and even undergraduate education. Thus, I would like to extend the scope of whole number arithmetic and talk about other number systems. Here, my intervention is connected to the discussion of the Davydov approach in this volume (Chap. 19).

15.6.2 Numbers

Let us begin with the notion of the number tree that often appears in school textbooks. Recalling our own learning experience, we can see that the concept of the number system is not presented in such a neatly packaged way in one stroke but is acquired in a vague and spiral fashion. Personally, I had been using the real numbers without much effort for many years in my secondary school days, but I did not know (and was not even aware that I did not know!) what real numbers were until I studied the subject as an undergraduate, and only gained a sufficient understanding when I came to teach mathematics as a young PhD student. The same process occurred in history as mankind went through the process of acquiring knowledge. Thus, it is likely that the number tree reveals itself in stages from kindergarten to primary school to secondary school to university as depicted below (Fig. 15.6).

The French mathematician Joseph-Louis Lagrange (1736–1813) referred to arithmetic and geometry as ‘the wings of mathematics’. Another French mathematician, Henri Poincaré (1854–1912), commented on the construction of the real number system:

If arithmetic had remained free from all intermixture with geometry, it would never have known anything but the whole number. It was in order to adapt itself to the requirements of geometry that it discovered something else. (Poincaré 2003, p. 135)

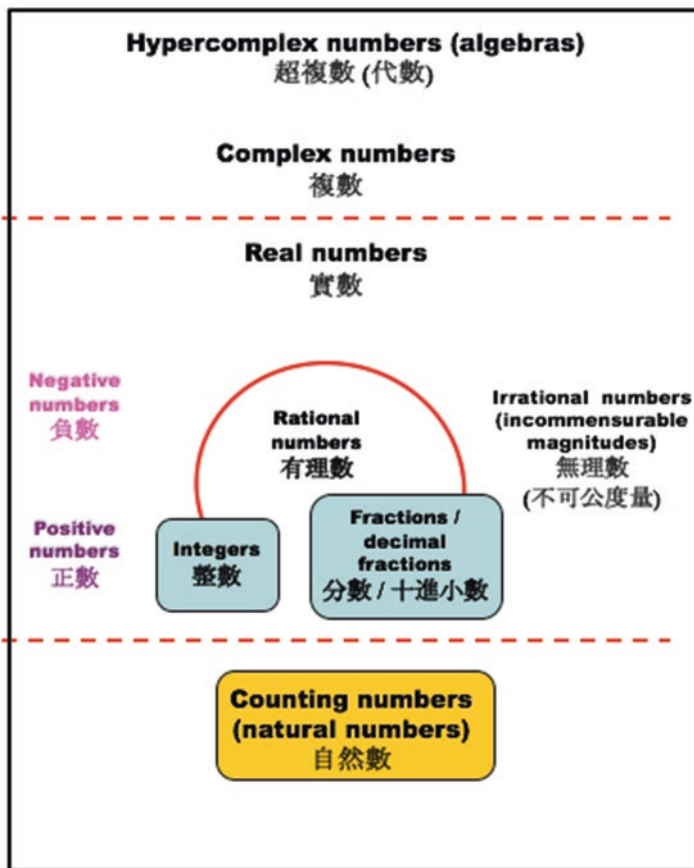

Fig. 15.6 Different number systems

15.6.3 The Chinese Translation of Euclid’s Elements

Here, I will try to address the issues raised by the other panellists about arithmetic and geometry. The panellists mentioned the discrete/continuous and algebraic/geometric characteristics of the number system and asked why the number line does not feature as prominently in the Chinese classroom as in the Western classroom. What M. Bartolini Bussi (Sect. 15.3) has in mind is the discrete number line, but allow me to extend the discussion to the real number line.

When the Ming official scholar Xu Guang-qi (徐光啟 1562–1633) collaborated with the Italian Jesuit Matteo Ricci (利瑪竇 1552–1610) in translating Euclid’s *Elements* into Chinese at the beginning of the seventeenth century, the title of the book was set as *Jihe Yuanben* (幾何原本 literally ‘source of quantities’). ‘*Jihe*’ is now the modern translation in Chinese of the term ‘geometry’. Some people assume that this translation arose as a transliteration of the Greek word ‘*geometria*’. There

are ample reasons to refute this assumption. Indeed, the Chinese translation of Book V of *Elements* makes it clear that ‘*jihe*’ is used as a translation of a technical term for magnitude, while its connotation for Xu Guang-qi is the term ‘how much or how many’ that appears frequently in ancient Chinese mathematical classics (Siu 2011). Thus, from the beginning, Xu Guang-qi noticed the significance of magnitude in Western mathematics and the metric nature of Euclidean geometry, so much so that he selected this term and incorporated it as part of the title of the translated text.

15.6.4 Jiuzhang Suanshu (九章算術 *Nine Chapters on the Mathematical Art*)

In the ancient Chinese tradition, geometry and algebra, or shapes and numbers, were integrated. Let us look at Problem 12 in Chap. 4 of the Chinese mathematical classic *Jiuzhang Suanshu* (九章算術 *Nine Chapters on the Mathematical Art*) compiled between the first century BCE and first century CE (Chemla & Guo, 2004). The problem states, ‘Now given an area 55,225 [square] *bu*. Tell: what is the side of the square?’ The text offers and explains an algorithm for extracting the square root. The following picture may explain the method more clearly (Fig. 15.7).

The text goes on to explain: ‘If there is a remainder, [the number] is called unextractable, it should be defined as the side on which the square has the area of the *shi*’. It would be too much to claim that this indicates the awareness of an irrational number in this ancient epoch, but apparently it is the name of what is now called a surd. Thus, Chinese mathematicians in this ancient epoch knew about the estimate of the square root of an irrational number.

Let me cite another example in *Jiuzhang Suanshu* to show how algebra and geometry were integrated in the ancient Chinese mathematical tradition. Problem 20 in Chap. 9 states, ‘Now given a square city of unknown side, with gates opening in the middle. 20 *bu*. from the north gate there is a tree, which is visible when one goes 14 *bu*. from the south gate and then 1775 *bu*. westward. Tell: what is the length of each side?’ (Fig. 15.8). In modern-day mathematical language, we can solve this as a quadratic equation, $x^2 + 34x = 71,000$.

The method outlined in *Jiuzhang Suanshu* is an extension of the extraction of the square root, known as the extraction of the square root with an accompanying number (帶從開方法). Again, the following picture may explain the method more clearly (Fig. 15.9).

Even more interesting is the way the equation is set up in a geometric context (Fig. 15.10).

In offering these examples, my aim has been to let you see how algebra and geometry, shapes and numbers, come together in the ancient Chinese tradition. However, the number line does not seem to be a familiar representation in this tradition, perhaps as a result of its algorithmic nature.

Fig. 15.7 Extraction of the square root

$a = 200 \quad a^2 = 40000$
 $55225 - 40000 = 15225$

$b = 30 \quad a^2 + 2ab = 12900$
 $15225 - 12900 = 2325$

$c = 5 \quad c^2 + 2c(a + b) = 2325$
 $2325 - 2325 = 0$

$x = 200 + 30 + 5 = 235$

a^2	ab	$c(a + b)$
ab	b^2	
$c(a + b)$		c^2

	ab	$c(a + b)$
ab	b^2	
$c(a + b)$		c^2

	<u>2</u>	<u>3</u>	<u>5</u>
	5	52	25
2			
43	1	52	
465	1	29	
		23	25
			23
			25

Fig. 15.8 Problem of the square city and tree

$$x^2 + 34x = 71000$$

$$x(x + 34) = 2 \times 20 \times 1775 = 71000$$

15.6.5 Tongwen Suanzhi (同文算指)

Primary mathematics education is important and difficult. It is difficult because no academic subject is easy; in particular, no one subject is easier than another. However, there is an additional reason, in my humble opinion, why it is difficult. Most people are affected by this difficulty, not just the primary school teachers and their pupils but most people, particularly those who are parents of primary school pupils. However, most people think that they know what primary mathematics

Fig. 15.9 Extraction of the square root with accompanying number

$34a$	a^2	ab	$c(a+b)$
$34b$	ab	b^2	
$34c$	$c(a+b)$		c^2

$$(a + b + c)^2 + 34(a + b + c) = 71000$$

$$a \in \{0, 100, 200, \dots, 900\}$$

$$b \in \{0, 10, 20, \dots, 90\}$$

$$c \in \{0, 1, 2, \dots, 9\}$$

$$a = 200 \quad a^2 + 34a = 46800$$

$$71000 - 46800 = 24200$$

$$b = 50 \quad b^2 + 2ab + 34b = 24200$$

$$24200 - 24200 = 0$$

$$c = 0$$

$$x = 200 + 50 + 0 = 250$$

education is and how it should be dealt with, because they were once primary school pupils. In other words, everybody considers themselves experts in this field! They do not think that they can learn from each other! As a semi-layman in this field, I am glad I have attended the ICMI Study 23. I have come to learn and, as the ancient Chinese classical text *Xueji* (學記) states, ‘Teaching and learning help each other [...] Teaching is the half of learning’. I am particularly glad to have joined the WG1 (Chap. 5) with culture as an emphasised component, and of course tradition, the subject of this panel.

My presentation in WG1 (Siu 2015a, b) concerns the book *Tongwen Suanzhi* (同文算指), compiled under the collaboration of the Italian Jesuit missionary Matteo Ricci and the Ming scholar official Li Zhi-zao (李之藻 1565–1630). This book first transmitted into China the art of *bisuan* (筆算 written calculation) (Siu 2015a, b). The term *tongwen*, meaning literally ‘common cultures’, indicates a deep appreciation of the common cultural roots of mathematics despite the different mathematical traditions.

In the preface of *Tongwen Suanzhi*, Xu Guang-qi wrote that:

The origin of numbers, could it not be at the beginning of human history? Starting with one, ending with ten, the ten fingers symbolise them and are bent to calculate them, [numbers] are of unsurpassed utility! Across the five directions and myriad countries, changes in cus-

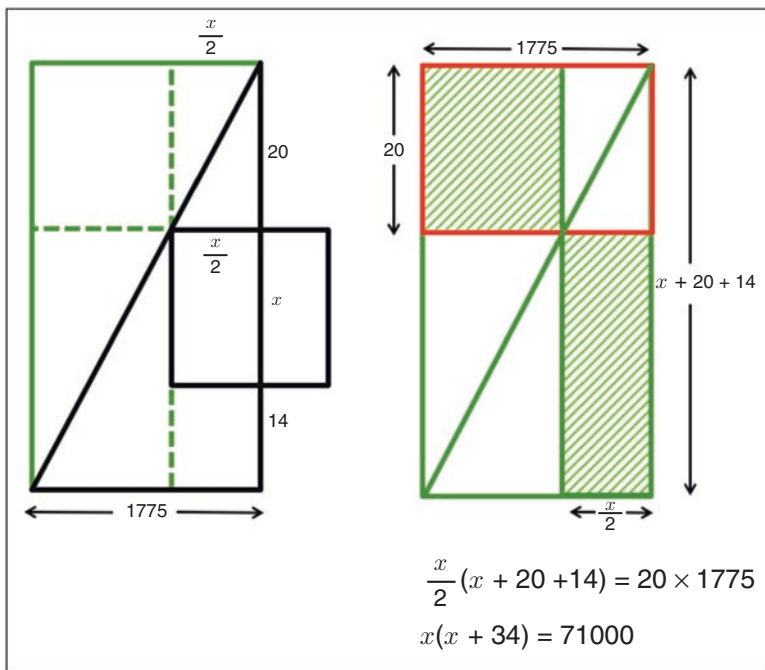

Fig. 15.10 Setting up a quadratic equation in a geometric context

toms are multitudinous. When it comes to calculating numbers, there are none that are not the same; that all possess ten fingers, there are none that are not the same.

In the preface to a reprinting of Matteo Ricci’s *Tianzhu Shiyi* (天主實義 *The True Meaning of the Lord of Heaven*), Li Zhi-zao wrote: ‘Across the seas of the East and the West the mind and reasoning are the same [*tong*]. The difference lies only in the language and the writing’.

15.7 Conclusion

The quotation from Li Zhi-zao that concludes the previous section deeply illustrates the rationale and problems of teaching/learning whole numbers in primary school. In fact, language and writing incorporate different cultural meanings according to which numbers are processed and conceived in different cultures. This is further reflected in the ways in which representations are used and interpreted in different cultural environments.

Many basic concepts of mathematics and whole numbers show the dramatic duality between mathematics as a universal language and its specific features of enculturation. The contributions from this panel widely illustrate this point.

This situation poses a great didactic challenge, which has the flavour of a paradox. On the one hand, the abstract universal concepts of mathematics are the goals of teaching and learning, but on the other hand, this goal can only be achieved by dealing with the concrete ways in which the concepts have been shaped by specific cultural tools, from oral and written words, to a variety of forms of representation (drawings, bodily expressions, etc.). This challenge constitutes the fascinating main feature of our work as mathematics educators and makes conducting research on this problem worthwhile.

Acquiring new knowledge on this issue is crucial because of the great social and economic changes the world is now facing. In recent years, economic globalisation, universal technological development and the related needs for manpower skills have provided strong historical motivations for introducing unified standards for mathematics in school. However, only a multicultural perspective allows us to consider the existence of different epistemological and cultural positions concerning mathematics and its cultural relevance and to realise the distance of the proposed curricular reforms from the mathematical cultures of different countries. It is important to base any teaching programme on its relationships with the cultures of the students and the personal contributions that they bring to the classroom. This will help avoid alienating the students from their cultural environment and allow them to engage in learning in a productive way.

The contributions of this panel pinpoint the crucial issues that need to be addressed to avoid the dangers of both the cultural refusal of innovation and of cultural alienation and of losing the cultural richness that exists in the different regions of the world.

References

- Adler, J. (1997). A participatory-inquiry approach and the mediation of mathematical knowledge in a multilingual classroom. *Educational Studies in Mathematics*, 33(3), 235–258.
- Arzarello, F., Robutti, O., & Bazzini, L. (2005). Acting is learning: Focus on the construction of mathematical concepts. *Cambridge Journal of Education*, 35(1), 55–67.
- Ascher, M. (1991). *Ethnomathematics: A multicultural view of mathematical ideas*. Pacific Grove: Brooks/Cole Publishing.
- Bartolini Bussi, M. G., Sun, X., & Ramploud, A. (2013). A dialogue between cultures about task design for primary school. In C. Margolinas (Ed.), *Proceedings of the International Commission on Mathematical Instruction Study 22: Task design in mathematics education* (pp. 549–558). Oxford. <https://hal.archives-ouvertes.fr/hal-00834054>. Accessed 20 Jan 2016.
- Barton, B. (2008). *The language of mathematics: Telling mathematical tales*. New York: Springer.
- Barwell, R., Clarkson, P., Halai, A., Kazima, M., Moschkovich, J., Planas, N., Setati Phakeng, M., Valero, P., & Villavicencio Ubillús, M. (Eds.). (2015). *Mathematics education and language diversity: The 21st ICMI study*. New York: Springer.
- Bazzanella, C. (2011). *Numeri per parlare*. Bari: Laterza.
- Bishop, A. J. (1991). *Mathematical enculturation: A cultural perspective on mathematics education*. Dordrecht: Kluwer Academic Publishers.

- Boero, P., & Guala, E. (2008). Development of mathematical knowledge and beliefs of teachers: The role of cultural analysis of the content to be taught. In P. Sullivan & T. Wood (Eds.), *International handbook of mathematics teacher education* (vol. 1, pp. 223–244). Rotterdam: Sense Publishers.
- Brissiaud, R., Clerc, P., & Ouzoulias, A. (2002). *J'apprends les maths – CP avec Tchou*. Paris: Retz.
- Butterworth, B., Reeve, R., & Reynolds, F. (2011). Using mental representations of space when words are unavailable: Studies of enumeration and arithmetic in indigenous Australia. *Journal of Cross-Cultural Psychology*, 42(4), 630–638.
- Chemla, K., & Guo, S.C.(郭書春). (2004). *Les Neuf Chapitres: Le Classique Mathématique de la Chine Ancienne et Ses Commentaires*. Paris: Dunod.
- D'Ambrosio, U. (2001). What is ethnomathematics, and how can it help children in schools? *Teaching Children Mathematics*, 7(6), 308–310.
- Dehaene, S., & Brannon, E. M. (Eds.). (2011). *Space, time, number in the brain: Searching for the foundations of mathematical thought*. London: Elsevier.
- Elementary Mathematics Department. (2005). Mathematics teacher manual: Grade 1 (Vol. 1). Beijing: People Education Press. [in Chinese].
- Gallistel, C. R., & Gelman, R. (2000). Non-verbal numerical cognition: From reals to integers. *Trends in Cognitive Sciences*, 4(2), 59–65.
- González, S., Valverde, G., Roncagliolo, R., & Luna, E. (2015). *Reporte final del Programa de Escuelas Efectivas PUCMM – MINERD- USAID*. Santiago de los Caballeros: Pontificia Universidad Católica Madre y Maestra.
- Gorgorió, N., & Planas, N. (2001). Teaching mathematics in multilingual classrooms. *Educational Studies in Mathematics*, 47(1), 7–33.
- Halliday, M. A. K., & Hasan, R. (1985). *Language, context, and text: Aspects of language in a social-semiotic perspective*. Oxford: Oxford University Press.
- Ifrah, G. (1985). *From one to zero. A universal history of numbers* (L. Bair, Trans.). New York: Viking Penguin Inc. (Original work published 1981.)
- Ifrah, G. (2001). *The universal history of computing: From the abacus to the quantum computer*. New York: Wiley.
- INVALSI. (2012). *Quadri di Riferimento. Primo ciclo di istruzione. Prova di Matematica*. http://www.invalsi.it/snv2012/documenti/QDR/QdR_Mat_I_ciclo.pdf. Accessed 20 Jan 2016.
- Joseph, G.G. (2011). *The crest of the peacock: Non-European roots of mathematics* (3rd ed.). Princeton: Princeton University Press.
- Jullien, F. (1996). *Si parler va sans dire: Du logos et d'autres ressources*. Paris: Seuil.
- Lam, L., & Ang, T. (2004). *Fleeting footsteps*. Singapore: World Scientific Publishing.
- Mathematics textbook developer group for elementary school. (2005). *Mathematics*. Beijing: People's Education Press. [In Chinese].
- Menninger, K. (1969). *Number words and number symbols: A cultural history of numbers*. Cambridge, MA: The MIT Press. (Translated from the German edition of 1958).
- MIUR. (1985). *Programmi della Scuola Elementare, D.P.R. 12 febbraio 1985, n 104*. <http://www.edscuola.it/archivio/norme/programmi/elementare.html#MATEMATICA>. Accessed 20 Jan 2016.
- MIUR. (2012). *Indicazioni nazionali per il curricolo per la scuola dell'infanzia e il primo ciclo dell'istruzione*. http://www.indicazioninazionali.it/documenti_Indicazioni_nazionali/indicazioni_nazionali_infanzia_primo_ciclo.pdf. Accessed 20 Jan 2016.
- MIUR-UMI. (2001). *Matematica 2001*. <http://www.umi-ciim.it/wp-content/uploads/2013/10/mat2001.zip>. Accessed 20 Jan 2016.
- Miura, I. T., Okamoto, Y., Kim, C. C., Chang, C.-M., Steere, M., & Fayol, M. (1994). Comparisons of children's cognitive representation of number: China, France, Japan, Korea, Sweden, and the United States. *International Journal of Behavioral Development*, 17(4), 401–411.
- Monti, M. M., Parsons, L. M., & Osherson, D. N. (2012). *Thought beyond language: Neural dissociation of algebra and natural language*. London: Psychological Science.

- Poincaré, H. (2003). *Science and method*. (F. Maitland, Trans.). New York: Dover. (Original work published 1908.)
- Radford, L. (2014). On the role of representations and artefacts in knowing and learning. *Educational Studies in Mathematics*, 85(3), 405–422.
- Rojas-Gamarra, M., & Stepanova, M. (2015). Sistema de numeración Inka en la Yupana y el Khipu. *Revista Latinoamericana de Etnomatemática*, 8(3), 46–68.
- Saxe, G. (2014). *Cultural development of mathematical ideas: Papua New Guinea studies*. Cambridge: Cambridge University Press.
- Schlepppegrell, M. J. (2007). The linguistic challenges of mathematics teaching and learning: A research review. *Reading & Writing Quarterly: Overcoming Learning Difficulties*, 23(2), 139–159.
- Selin, H., & D'Ambrosio, U. (2000). *Mathematics across cultures: The history of non-western mathematics*. Dordrecht: Springer.
- Sinclair, N., & Metzuyanin, E. (2014). Learning number with TouchCounts: The role of emotions and the body in mathematical communication. *Technology, Knowledge and Learning*, 19(1), 81–99.
- Siu, M. K. (蕭文強). (2011). 1607, a year of (some) significance: Translation of the first European text in mathematics — Elements — Into Chinese. In Barbin, E., Kronfeller, M., & Tzanakis, C. (Eds.). *History and epistemology in mathematics education* (pp. 573–589). Vienna: Verlag Holzhausen.
- Siu, M. K. (蕭文強). (2015a). Tongwen Suanzhi (同文算指) and transmission of bisuan (筆算 written calculation) in China: From an HPM (History and Pedagogy of Mathematics) viewpoint. *Journal for History of Mathematics*, 28(6), 311–320.
- Sun, X. (2011). Variation problems and their roles in the topic of fraction division in Chinese mathematics textbook examples. *Educational Studies in Mathematics*, 76(1), 65–85.
- Sun, X. (2013). The structures, goals and pedagogies of “variation problems” in the topic of addition and subtraction of 0–9 in Chinese textbooks and reference books. *Proceedings of the Eighth Congress of European Research in Mathematics Education (CERME 8, WG 16)*, 2208–2218.
- Sun, X. (2016a). 《螺旋變式—中國內地數學課程與教學之邏輯》 新加坡八方文化創作室. *Spiral variation: A hidden theory to interpret the logic to design Chinese mathematics curriculum and instruction in mainland China*. Singapore: World Scientific Publishing.
- Sun, X. (2016b). Uncovering Chinese Pedagogy: Spiral variation—the unspoken principle for algebra thinking to develop curriculum and instruction of “TWO BASICS”. *Invited paper in 13th International Congress on Mathematical Education (ICME-13)*.
- Usiskin, Z. (1992). Thoughts of an ICME regular. *For the Learning of Mathematics*, 12(3), 19–20.
- Varley, R. A., Klessinger, N. J. C., Romanowsky, C. A. J., & Siegal, M. (2002). Agrammatic but numerate. *Nature Reviews. Neuroscience*, 3, 462–471.
- Vergnaud, G. (1991). Langage et pensée dans l'apprentissage des mathématiques. *Revue Française de Pédagogie*, 96, 79–86.
- Vergnaud, G. (1997). The nature of mathematical concepts. In T. Nunes & P. Bryant (Eds.), *Learning and teaching mathematics: An international perspective* (pp. 5–28). Hove: Psychology Press.
- Villa, B. (2006). *Numeri cinesi e oltre*. <http://gold.indire.it/nuovo/gen/cerca-s.php?parola=Numeri+cinesi+%26+oltre&submit=Cerca>
- Villavicencio Ubillús, M. (1990). *La matemática en la educación bilingüe: el caso de Puno*. Lima: Programa de Educación Bilingüe-Puno.
- Zaslavsky, C. (1973). *Africa counts: Number and pattern in African culture*. Chicago: Lawrence Hill Books.
- Zhang, D. (2006). *The “two basics”: Mathematics teaching in mainland China*. [in Chinese]. Shanghai: Shanghai Education Press.

Cited papers from Sun, X., Kaur, B., & Novotna, J. (Eds.). (2015). Conference proceedings of the ICMI study 23: Primary mathematics study on whole numbers. Retrieved February 10, 2016, from www.umac.mo/fed/ICMI23/doc/Proceedings_ICMI_STUDY_23_final.pdf

Bartolini Bussi, M. G. (2015). The number line: A ‘Western’ teaching aid (pp. 298–306).

Mellone, M., & Ramploud, A. (2015). Additive structure: An educational experience of cultural transposition (pp. 567–574).

Siu, M. K. (2015b). Pedagogical lessons from *Tongwen Suanzhi* (同文算指): Transmission of *bisuan* (笔算 written calculation) in China (pp. 132–9).

Soury-Lavergne, S., & Maschietto, M. (2015). Number system and computation with a duo of artifacts: The pascaline and the e-pascaline (pp. 371–378).

Sun, X. (2015). Chinese core tradition to whole number arithmetic (pp. 140–148).

Open Access This chapter is licensed under the terms of the Creative Commons Attribution 4.0 International License (<http://creativecommons.org/licenses/by/4.0/>), which permits use, sharing, adaptation, distribution and reproduction in any medium or format, as long as you give appropriate credit to the original author(s) and the source, provide a link to the Creative Commons license and indicate if changes were made.

The images or other third party material in this chapter are included in the chapter’s Creative Commons license, unless indicated otherwise in a credit line to the material. If material is not included in the chapter’s Creative Commons license and your intended use is not permitted by statutory regulation or exceeds the permitted use, you will need to obtain permission directly from the copyright holder.



Chapter 16

Special Needs in Research and Instruction in Whole Number Arithmetic



Lieven Verschaffel 
Anna Baccaglioni-Frank , Joanne Mulligan ,
Marja van den Heuvel-Panhuizen , Yan Ping Xin , and Brian Butterworth 

16.1 General Introduction

Lieven Verschaffel

Many children have difficulties or problems with learning mathematics. While these difficulties or problems may occur at any stage in learners' mathematical development, by far the most attention of researchers and practitioners goes to the domain of early and elementary mathematics and, more specifically, to the domain of whole number arithmetic (WNA). Even though the issues of diagnosis of and instruction

Electronic Supplementary Material The online version of this chapter (doi:[10.1007/978-3-319-63555-2_16](https://doi.org/10.1007/978-3-319-63555-2_16)) contains supplementary material.

L. Verschaffel (✉)
Katholieke Universiteit Leuven, Leuven, Belgium
e-mail: lieven.verschaffel@kuleuven.be

A. Baccaglioni-Frank
Università di Pisa, Pisa, Italy

J. Mulligan
Macquarie University, Sydney, NSW, Australia

M. van den Heuvel-Panhuizen
Utrecht University, Utrecht, the Netherlands

Y.P. Xin
Purdue University, West Lafayette, IN, USA

B. Butterworth (discussant)
University College London, London, UK

for children with special mathematical learning needs are getting increasing research attention, research in this area is still lagging behind compared with other academic subjects such as reading. Hereafter, we list some major open questions for research and practice.

First, there is the terminological issue. Defining mathematical learning difficulties, problems or disabilities (hereafter abbreviated as MLD) is not an easy task (Berch and Mazzocco 2007). Despite the solid knowledge base that has been achieved in this field, more substantial progress in understanding and addressing MLD would be facilitated by establishing agreement on consistently used terminology and use of standardised criteria concerning the nature and seriousness of the disability. While certain definitions explicitly refer to a biologically based disorder, others emphasise the discrepancy between the child's mathematical achievement and his/her general intelligence as the main criterion, and others still focus on the response to intervention. But the field of MLD also lacks coherence and consensus about what constitutes 'mathematics' in MLD. Within MLD research, there is a history of predominance to focus on memorisation of arithmetic facts and automatisa-tion of arithmetic procedures. A less (neuro)psychologically dominated and more interdisciplinary approach might bring a broader, more coherent and balanced perspective that takes into account both the views about mathematics learning as arithmetic and other equally important perspectives such as spatial and geometrical reasoning, mathematical relations and patterns and other forms of mathematical thinking with more potential towards abstraction and generalisation (Hord and Xin 2015; Mulligan 2011). Evidently, besides children with MLD, there are also other children requiring special mathematics educational support, but they are not diagnosed as MLD, such as children with intellectual disabilities; children with auditory, visual or motoric impairments; children with serious emotional and/or behavioural problems; or, finally, children with long-standing inappropriate instruction or environmental deprivation (De Smedt et al. 2013).

A second major concern of researchers in the field is to characterise the various cognitive mechanisms that are implicated in the development of MLD. Several cognitive explanations for the presence of MLD have been put forward. Most of the available research on MLD has dealt with domain-general cognitive factors, such as poor working memory and difficulties with the retrieval of phonological information of long-term memory. More recently (and against the background of findings from neuroimaging research), it has been proposed that MLD arises as a consequence of domain-specific impairments in number sense or the ability to represent and manipulate numerical magnitudes (Butterworth 2005; Landerl et al. 2004). For example, children with MLD have particular difficulties in comparing two numerical magnitudes and in putting numbers on a number line, both of which are thought to measure one's understanding of numerical magnitude. Although various cognitive candidates have been put forward to explain MLD, the existing body of data is still in its infancy. According to Karagiannakis et al. (2014), although the field has witnessed the development of many classifications, no single framework or model can be used for a comprehensive and fine interpretation of students' mathematical difficulties, not only for research purposes but also for informing mathematics educators. Starting from a multi-deficit neurocognitive approach and building on the

available literature, these authors have recently proposed a classification model for MLD describing four cognitive domains within which specific deficits may reside.

Third, initial accounts of MLD in the 1970s suggested that MLD was due to brain abnormalities. With the advent of modern neuroimaging techniques, researchers have begun to address this issue. There is converging evidence for the existence of a frontoparietal network that is active during number processing and arithmetic (Ansari 2008). Studies that examine this network in children with MLD are currently slowly but steadily emerging. These few studies consistently indicate that children with MLD have both structural and functional alterations in the above-mentioned frontoparietal network, particularly in the intraparietal sulcus, which is the brain circuitry that supports the processing of numerical magnitudes, and (pre)frontal cortex, which is assumed to have an auxiliary role in the maintenance of intermediate mental operations in working memory. Furthermore, it has been suggested that these brain abnormalities in children with MLD are probably of a genetic origin, yet the genetic basis of MLD remains largely unknown and no genes responsible for mathematics (dis)abilities have been identified. Studies in the field of medical genetics have revealed that some disorders of a known genetic origin, such as Turner syndrome and 22q11 deletion syndrome, show a consistent pattern of MLD. Furthermore, there is some early evidence of links to autism spectrum disorders and Asperger's.

The fourth and final issue relates to the question: what are appropriate educational interventions for children with MLD? Originally, general perceptuo-motor training was the dominant way of remediating learning disorders, but the effects of this type of training have been discounted. Interventions that target those specific components of mathematics with which a child with MLD has difficulty appear to be the most effective (Dowker 2008). Such intervention involves the assessment of a child's strengths and weaknesses in mathematics, and this profile is taken as an input to remediate specific components of mathematical skill. However, several major questions remain: what is the appropriate moment to diagnose MLD and to start specific interventions? Do MLD children profit more from individualised interventions organised out of the regular mathematics class or do they profit more from being integral part of the regular mathematics class? Do these children need a special kind of intervention or do they profit most from the same kind of instruction as children without MLD? More specifically, is conceptually based and constructivist-oriented mathematics instruction also suitable for children with learning disabilities (Xin and Hord 2013; Xin et al. 2016)? Another issue is whether we do not have a blind spot when making assumptions about what children with MLD can do, rather than what they cannot do (Peltenburg et al. 2013). Finally, does the remedial instruction of children with MLD pay enough attention to other aspects of mathematics than whole number sense, such as to conceptual relationships that may develop from spatial reasoning? Clearly, it may not be productive to try to answer these major educational questions for all categories of children who have serious trouble with learning mathematics.

So, although the last decades have witnessed a serious growth in research into the diagnosis, remediation and prevention of MLD, much work remains to be done. Longitudinal research is needed to identify developmental precursors and to delin-

erate developmental trajectories of MLD. The neural basis of these difficulties and their association with classroom performance certainly need to be further explored. Understanding the different characteristics of MLD at different levels – the behavioural, the cognitive and the neurobiological – will inform appropriate educational interventions. The design and evaluation of these remedial interventions needs to be a priority on the agenda for future research. These interventions may not only treat the difficulties but also prevent them. And, finally, there is a great need to look beyond diagnoses and interventions that are merely focused on counting and arithmetic to those also involve other aspects of mathematical thinking which hold more promise for abstraction and generalisation.

The goal of the ICMI Study 23 panel on special needs was to explore and discuss the above issues and challenges, with a strong emphasis on the last issue, namely, instructional goals and interventions for children with MLD. The panel consisted of four scholars with complementary specialisations in the domain of children with MLD and other special needs in the curricular domain of whole number arithmetic, namely, Anna Baccaglioni-Frank ('La Sapienza' University, Rome, Italy), Joanne Mulligan (Macquarie University, Sydney, NSW, Australia), Marja van den Heuvel-Panhuizen (Utrecht University, Utrecht, The Netherlands) and Yan Ping Xin (Purdue University, West Lafayette, IN, USA), complemented by one of the keynote speakers of the ICMI Study 23 Conference, Prof. Brian Butterworth (University College, London, UK), a world-leading scholar in the domain of the (neuro)cognitive roots of dyscalculia and its treatment, who acted as discussant.

16.2 Does 'Dyscalculia' Depend on Initial Primary School Instruction?¹

Anna Baccaglioni-Frank

In this contribution, I address the questions of whether (1) MLD children profit more from individualised interventions organised out of the regular mathematics class or from being an integral part of the regular mathematics class; (2) these children need a special kind of intervention or whether they profit most from the same kind of instruction as children without MLD; (3) the answers to the above questions are the same for all categories of children with MLD.

Let me start with the last question. Assuming that 'categories of children with MLD' is a well-defined construct (though I do not believe it yet is), in my opinion the answer is 'no'.

First of all, for the same child, the answers may vary at different stages of his/her life. For example, before any diagnosis is made (and some would argue, even after), many would probably claim that, at least initially (and perhaps always), the child should be in the 'regular' classroom and experience conceptually based,

¹The study was possible thanks to the PerContare Project, coordinated by Fondazione ASPHI onlus, with the support of Compagnia di San Paolo and the operative support of Fondazione per la Scuola of Compagnia di San Paolo of Torino.

constructivist-oriented instruction (to use the same terms as in questions 2 and 3). But what if during a whole year, or even worse a whole school cycle (5–6 years), the child – for a variety of reasons – does not participate in the classroom discourse during the mathematics hours? This can be the case, for example, if the classroom culture is heavily based on written language and the child has not overcome difficulties related to the use of this medium, a frequent condition in cases of dyslexia. The child will have wasted years of his/her life, or even worse, he/she will have developed aversion for the discourse he/she failed to become a part of. Perhaps the child's environment would have been more aware of his/her difficulties with written language, if the child had spent time in a special education classroom, offering a context in which participation was fostered in a more appropriate way, leading to experiences of participation and success in mathematics.

However, after many years of (induced or voluntary) exclusion from mathematical discourse, throughout which the child – now adolescent – has never actually done mathematics, is it still appropriate to place him/her in a 'regular' classroom involving constructivist-oriented instruction that heavily builds on notions our student has never constructed? He/she will almost definitely fail mathematics for good.

On the other hand, it is possible that with an individualised remedial intervention that takes into account the student's (well-known) difficulties, he/she will rapidly regain confidence and start participating in a mathematical discourse that uses different means for acquiring and producing information and that can be appreciated by the teacher and by all the other participants in the mathematical discourse, even those within the 'regular' classroom. Throughout my experience in helping students learn mathematics in different settings, I have witnessed a number of cases similar to the prototypical one just described.

In the example, I mentioned difficulties in using written language; however, there can be many other cognitive conditions, such as a difficulty to remember procedures or facts, difficulties in encapsulating processes, difficulties in logical reasoning and many others that lead to experiencing failure and eventually to exclusion from the mathematical discourse produced in 'regular' classrooms. I believe it is fundamental (for the teacher, clinician or other educator) to identify these difficulties and 'work around' them, helping the student become aware of them while addressing and overcoming whichever ones are possible. Of course this is no trivial task and each student is quite different!

Returning to the last question, it also seems to be the case that, at a given point in time, different students can have different characteristics. For example, taking a cognitive perspective, it seems possible to regroup existing hypotheses on MLD into a fourfold model that can be used for describing students' mathematical (cognitive) learning profiles (Karagiannakis et al. 2014). Studies based on this assumption are showing that the profiles of students with similar (or identical) low scores on mathematical achievement tests (also those used for diagnosing MLD) are in fact different (Karagiannakis and Baccaglioni-Frank 2014; Karagiannakis et al. 2018). In other words, the studies are suggesting that failure to overcome difficulties in mathematical learning, at a cognitive level, cannot always be associated with a single deficit

in a particular domain of the model, nor can it be considered the consequence of *one* particular finalised combination (that is the same for all students) of deficits. This supports the claim that looking for a cognitive characterisation of all students with low achievement specifically in mathematics is not necessarily a fruitful direction of research.

What we can (and should) ask is, ‘why do some children fail to overcome difficulties in mathematical learning that others do overcome?’ Reasons may include students’ cognitive characteristics, as a result of ‘innate’ inclinations that are shaped by immersion in society (as mentioned above), students’ mathematical learning history, affective components of both the students and their teachers, teachers’ choices about what mathematical content to present and the means they choose (or do not choose) to introduce it, the way MLD is viewed within school policies and teachers’ perspectives, implicit or explicit assumptions on ‘what’ or ‘how much’ MLD students can learn, etc.

I believe that research conducted by mathematics educators should address how to minimise failure in mathematics due to children’s individual specific learning characteristics, as early as possible – starting at least at the beginning of formal instruction (kindergarten or first grade in most countries). This is what we attempted to do in a 3-year project recently carried out in Italy (2011–2014). For this project, a team of mathematics educators and psychologists designed curricular material for mathematics, framed within the theories of semiotic mediation (Bartolini Bussi and Mariotti 2008) and embodied cognition (Gallese and Lakoff 2005), with the aim of providing all students (in first and second grade) with ‘hands-on’ (kinaesthetic-tactile) experiences that involve manipulation of physical artefacts to develop mathematical meanings (including procedures) from these and from consequent mathematical discussions.

For example, to help children learn what are known in English as the ‘multiplication tables’, children were introduced to the manipulation of rectangles cut out of squared paper (see Sect. 7.4.2 of Chap. 7). Children learned to cut and paste these rectangles together to figure out unknown products. The physical procedures were then carried out simply by drawing (in notebooks or on the blackboard), and eventually children started to use them with no further external support, as strategies of mental calculation (see the example in Sect. 7.4.2 of Chap. 7). A fundamental aspect of the mathematical activity stemming from activities such as the ones described is the sharing and discussing of strategies, during which all students were invited to (and did!) contribute.

In the episodes shown in part 4 of the video (Electronic Supplementary Material: Baccaglioni-Frank 2017b), the teacher has asked the children to share strategies they used to figure out 8×6 , showing their procedure on the blackboard. One student has decided to break the segment 8 into three parts (5, 2 and 1), which for him ‘make it easy’ because they are numbers he knows how to count by. He then counts up by 5s to obtain the first piece, mentally rotates the second piece and remembers that $6 + 6 = 12$ and recognises the last piece as 1×6 . So he finally adds $30 + 12 + 6$. The student in general performs at an average-low level, but he was able to keep up with the class using the proposed activities and occasional extra practice at home.

Another student had decided to decompose 8 into $10 - 2$ and describes her reasoning through ‘ghost rectangles’,² a terminology that very quickly catches on in the classroom. These are rectangles that appear to make the calculation easier, but then they need to be taken away. She uses ghost rectangles to think of 8 as a part of 10, to reach the product $10 \times 6 (= 60)$, and then subtract off $2 \times 6 (= 12)$. In the final mental calculation ($60 - 12$), she makes a mistake: at first, she forgets to take a second 10 from 60 and ends up with 58 instead of 48. Then, prompted by the teacher, she quickly corrects the mistake. Both students seem to be very much at ease when implicitly using the distributive property (it was not presented formally).

An important finding of the project was that working with the experimental materials through first and second grade significantly reduced the number of children who could be classified as MLD by third grade (Baccaglini-Frank and Scorza 2013; Baccaglini-Frank and Bartolini Bussi 2015; Baccaglini-Frank 2015). Moreover, the children exposed to the PerContare teaching-learning experience developed a variety of strategies for addressing different mathematical situations. In particular, with respect to calculation, for these children, the acquisition of numerical facts occurred with greater accuracy, variety of strategies and eventually speed. The ‘cost’ was a 3-month lag in fact and automatisation compared with the higher performing children in the control classes.

Insisting on the finding that persistent use of particular curricular materials can significantly reduce the number of children who tested positively for dyscalculia in third grade, we find an apparent contradiction with the literature claiming that dyscalculia is an innate deficit. Indeed, our sample of students seems to show that testing positively for dyscalculia can depend on initial primary school instruction, an extremely ‘cultural’ experience. Of course, one can solve the dilemma in a number of ways, for example by attacking the effectiveness of diagnostic test batteries (at least those used in Italy) or the diagnostic criteria more in general, or by speaking more loosely of MLD without giving a clear definition, which indeed, unsurprisingly, has not yet been agreed upon across groups of research (e.g. Mazzocco and Räsänen 2013).

This brings me back to my earlier plea: as educators, we should continue studying why fewer students fail in mathematics when they participate in particular types of early mathematical experiences. Let us call these good practices. I believe that particular effort should be put in developing good practices and studying their effect with different samples of children. At this point, when a set of good practices has been identified, we can ask whether there are students who still fail in mathematics and set up studies to explore why this is the case, then possibly use such knowledge to further ameliorate the practices or, in parallel, develop ad hoc remedial interventions. My personal belief is that it is unlikely that many students now classified as MLD will benefit more from individualised interventions than from whole-class learning situations where they make use of good practices which afford multiple

²This may also be seen as a *pivot sign* according to the Theory of Semiotic Mediation (Bartolini Bussi and Mariotti 2008) and was exploited as such by the teacher.

means of participation in the mathematical discourse and which are considerate of the learning inclinations of all students. But of course this is yet an open question.

16.3 Are MLD Linked to a Lack of Underlying Awareness of Mathematical Patterns and Relationships that Are More Linked to Spatial Ability than Development of Number?

Joanne Mulligan

To address some of the issues articulated in the introduction of this chapter, I will adopt an integrated perspective, in order to provide a more coherent view of the underlying cognitive bases of mathematical development and MLD based on an awareness of mathematical ‘pattern and structure’. Rather than focusing on the domain of WNA, my research has focused on supporting the development of mathematical generalisation – through early identification of patterns and relationships and the development of interrelated spatial processes.

In recent years, mathematics education research has turned increasing attention to other research domains and interdisciplinary studies to explain and describe the wide variation in mathematical competence in the early years.

Studies of early mathematical competencies have largely emphasised children’s numerical competencies, e.g. counting, subitising, representing number, numerical magnitudes and positioning on an empty number line (De Smedt et al. 2013; Fias and Fischer 2005). Another approach has focused on children’s spontaneous focusing on number and quantitative relations (Hannula and Lehtinen 2005) found to be predictive of later achievement. Related studies highlight the critical role of perceptual subitising (McDonald 2015) and the spatial structuring of groups in arrays (Starkey and McCandliss 2014). Neurocognitive studies (Butterworth et al. 2011) also provide complementary evidence of the connection between the development of number and arithmetic and spatial processes. Number concepts depend on processes such as subitising (the rapid and accurate perception of small numerosities), comparison of numerical magnitudes, location on a number line, axis differentiation and symmetry (e.g. Dehaene 2009). Some interventions have incorporated some of these aspects for students with MLD and those performing below specified benchmarks, but with a focus on counting and arithmetic rather than underlying mathematical attributes.

The relative influence of the various components and how they interrelate in mathematical development, especially for students with MLD, remains unclear. Moreover the influence of one or more of these components on the individual’s mathematical development may vary widely.

Recent developmental studies have indicated the positive impact of the early development of spatial skills on mathematical development (Verdine et al. 2014). Other studies in mathematics education highlight the sustained development of spatial reasoning skills from an early age – these are malleable and can be augmented

over time but can weaken if not supported (Davis 2015). Spatial ability has also been linked to development of patterning and early algebraic skills (Clements and Sarama 2011; Papic et al. 2011) and the relationship with other concepts such as number and measurement (Mulligan et al. 2013; Mulligan et al. 2015). This raises critical questions about the need for differentiated teaching, assessment and intervention programmes for learners with poor spatial skills, not exclusive to those identified with MLD.

The Australian Pattern and Structure Mathematics Awareness Project (see also Sect. 7.3.3 of Chap. 7) is a suite of related studies with 4–8-year-olds focused on the assessment of mathematical structures for children representing a wide range of abilities including children with MLD (Mulligan et al. 2013). These studies have taken into account the complexity of various components of mathematical competency by adopting a more integrated view: what are common salient features of early mathematical development? Does the ability to recognise patterns and structures reflect innate ability or can it be developed? Why do some children with MLD lack this ability? What is the role of spatial reasoning?

The project, spanning over a decade, involved the development and validation of an interview-based assessment instrument the *Pattern and Structure Assessment – Early Mathematics (PASA)* (Mulligan et al. 2015) and the evaluation of the *Pattern and Structure Mathematics Awareness Program (PASMMap)* (Xin et al. in press). On the basis of students' PASA responses drawn from a range of studies, five levels of structural development were identified and described: prestructural, emergent, partial, structural and advanced structural (see Mulligan et al. 2013). Students with low AMPS operated generally at the prestructural or emergent level: for example, they had difficulty subitising larger sets, recognising a unit of repeat in simple patterns or utilising the structural features of arrays. They were most likely to represent idiosyncratic or superficial features in their models, drawings and explanations.

Based on early studies on patterning, counting, the numeration system and multiplicative thinking, the research focused on identifying and describing common characteristics, later coined as the construct *Awareness of Mathematical Pattern and Structure (AMPS)*. AMPS has two interdependent components: one cognitive (knowledge of structure) and one meta-cognitive (a tendency to seek and analyse patterns). The AMPS construct involves the following structural components:

- *Sequences*: recognising a (linear) series of objects or symbols arranged in a definite order or using repetitions, i.e. repeating and growing patterns and number sequences.
- *Structured counting and grouping*: subitising, counting in groups, such as counting by 2s or 5s or on a numeral track with the equal grouping structure recognised as multiplicative.
- *Shape and alignment*: recognising structural features of two- and three-dimensional (2D and 3D) shapes and graphical representations, constructing units of measure, such as colinearity (horizontal and vertical coordination), similarity and congruence and such properties as equal sides, opposite and adjacent sides, right angles, horizontal and vertical parallel and perpendicular lines.

- *Equal spacing*: partitioning of lengths, other 2D or 3D spaces and objects into equal parts, such as constructing units of measure. It is fundamental to representing fractions, scales and intervals.
- *Partitioning*: division of lengths, other 2D or 3D spaces, objects and quantities, into unequal or equal parts, including fractions and units of measure.

Remedial or intervention initiatives in early numeracy for students with MLD typically focus on number and arithmetic without paying attention to patterning and spatial processes. Yet increasing evidence from a number of disciplines points to other components contributing to numerical competence. Our studies have traced the early development of number and other mathematical concepts to the development of AMPS. The PASMMap intervention studies, which examine the development of spatial aspects of patterns and spatial structures across mathematics concepts, indicated that such features as differentiation of foreground/background, alignment (collinear or axis), unitising and equal grouping, transformation and recognition of shape and equal areas are critical to mathematical development. It was found that these aspects can be improved through intervention for some children with MLD (Mulligan et al. 2013).

The design of the PASMMap intervention takes account of the assessment (PASA) which measures the child's level of AMPS; however, the programme can be utilised in conjunction with other assessments and intervention strategies. The PASMMap intervention programme was designed and trialled with students with wide-ranging abilities including those with MLD. PASMMap focused on five structures described above and is flexible in its implementation because the teacher can target specific mathematical structures with which a child with MLD has most difficulty. The pedagogy is designed to move students towards identifying similarities and differences, with a view to representing and abstracting core structural elements. The use of visual memory to record spatial representations is emphasised.

I propose that development of the various components of mathematical competence described in the literature earlier must have interrelated influences on mathematical development, but there is a common underlying thread. I am not suggesting that components are simply amalgamated into the construct that we call AMPS. Our empirical evidence supports the promotion of structural features rather than emphasis on counting and arithmetic. Fine-grained analysis of children's development over time suggests a complex network of these PASMMap components: the common denominator is the ability to see patterns and structural features that are essentially or initially spatial in nature. Hence the importance of focusing on children's development of structures such as grouping and partitioning, unitising, subunitising, collinearity and benchmarking numerical magnitudes.

Conceptual relationships in mathematics depend on AMPS: spatial structuring and recognising patterns may provide the inextricable link between spatial and number development. Our recent studies have linked a measure of AMPS to standardised measures of early numeracy (Mulligan et al. 2015). Further analysis utilising network analysis (Woolcott et al. 2015) provides visual links between AMPS structures as a map of connectivity. However, the role of spatial reasoning in the

development and use of AMPS is not fully understood; what our studies have described are domain-specific aspects of AMPS such as spatial structuring, partitioning and structuring linear, two-dimensional and three-dimensional space and relations between pattern and number.

Our future studies focus on evaluating the impact of various structures within the PASMMap intervention with children with MLD, moreover identifying critical differences for individuals in terms of AMPS over time. This may require a considered review of what constitutes critical components in early mathematical development and improved cross-disciplinary collaboration to inform research agendas and more effective pedagogical innovations.

16.4 It Is Time to Reveal What MLD Students Know, Rather than What They Do Not Know

Marja van den Heuvel-Panhuizen

Good teaching starts with getting to know what students know. Although this applies to all students, it is particularly true for students who have mathematical learning difficulties (MLD). Unfortunately, the problem with these students is that they usually have low scores on mathematics tests, which may automatically lead to the conclusion that they are ignorant, that they are unable to solve demanding mathematical problems and that it cannot be expected that they can come up with their own solution methods. Unmasking these and other prejudiced ideas is of vital importance for MLD students, because it may open new opportunities for teaching them mathematics. However, the burning question is how we can reveal what MLD students *do* know. In this contribution, I will discuss some research findings that give rise to reconsidering the presumed limitations of MLD students.

My research activities in this field started at the beginning of the 1980s when I got acquainted with an approach to mathematics education that proposes to start from students' informal and context-related mathematical knowledge, to offer students models to eventually reach more general and formal levels of understanding, to go beyond the sole focus on whole number operations, but also includes other mathematical domains, to give students an active role in the learning process, to elicit reflection, to stimulate classroom interaction about different solution strategies and to aim not only at learning facts and skills, but also at gaining insight.

As a former special education teacher, I was surprised that special educationalists rejected this kind of teaching for students in special education. According to these educationalists, it would be better to teach MLD students only a fixed solution strategy; otherwise, they would get confused. Also, it would be better to teach MLD students bare number problems, because problems situated in contexts would make problems too complex for them. Furthermore, building on students' own informal solution methods would be an illusion, because MLD students can hardly come up with solutions by themselves (see more about these assumptions of special educationalists in van den Heuvel-Panhuizen 1986, 1996).

To challenge these, in my view, incorrect assumptions, in 1990, I set up a study (van den Heuvel-Panhuizen 1996) in two special education schools for mildly mentally retarded students. The age of the students was between 10.5 and 13 years. The students' mathematical levels were far behind their peers and lay between grades 2 and 4 of regular primary school. The topic I chose for this study was ratio, which is generally considered beyond the reach of students in schools for mildly mentally retarded students and which accordingly was not taught to the students who participated in the study. In order to provide evidence that this was an underestimation of their mathematical ability, I administered a test on ratio including 16 ratio problems all referring to contextual situations familiar to the students and not including formal notations of ratio. Instead, as Freudenthal suggested to me when I designed the test, I made use of the visual roots of ratio. The results revealed that the MLD students, without having had instruction on ratio, were quite able to solve the problems. The percentage of correct answers for the problems ranged from 13% to 64%. Both the teachers of these students and the experts (two special education school inspectors and two special educationists) who were asked to predict the students' scores in many cases underestimated them. Moreover, the scrap papers added to the test sheets showed clear traces of self-invented strategies and notations.

The often-heard claim that students who are weak at mathematics can be better taught only one fixed standard strategy for every operation (e.g. see Gelderblom 2008, p. 36: 'Letting students who are weak in mathematics discover strategies by themselves is fatal. Lead them by the hand, tell them which strategies they have to use'; translation into English by author) induced me and my PhD student Marjolijn Peltenburg in 2010 to set up a study in which we investigated how special education students solve subtraction problems up to 100. The standard strategy that MLD students are taught for this type of problems is the take-away strategy. On purpose, we also included in the subtraction test for this study problems that might elicit an adding-on strategy (e.g. bare number problems such as $62 - 58$ and context problems with an adding-on context). What we found was that the MLD students, without being taught, made spontaneous use of the adding-on strategy. Moreover, they were rather flexible in what strategy they applied, and they were quite successful when applying the adding-on strategy (Peltenburg et al. 2012).

Besides offering MLD students assessment problems in which they could show their competence on topics that belong to the regular mathematics curriculum, we also did further research on a topic that is far beyond what is taught in special primary school education and even is lacking in regular primary school. In this research we investigated what happened when MLD students were asked to solve a number of combinatorics problems. Here we found that the MLD students in our study were equally successful in solving the combinatorics problems as their comparable peers in regular education, who were younger but at the same level of understanding number and operations. Moreover, on average the MLD students equally often applied a systematic strategy to find all possible combinations as the students in regular education, and in both school types, a significant increase in the use of systematic strategies could be observed (Peltenburg et al. 2013; Peltenburg 2012, Chap. 6).

Problem 1

When a battery is full, it will work 120 hours.
It is still charged for 40%.
For how many hours will this battery still work?
Answer: hours









		scrap paper empty
		scrap paper with grid
		bar
		table

Fig. 16.1 Percentage problem in the DAE with optional auxiliary tools

Another avenue in our search for possibilities to make the hidden mathematical potential of MLD students visible is the use of a technology-enhanced assessment. For this we put a series of subtraction problems from a standardised test into an ICT environment and extended them with optional auxiliary tools. In one study, we used a digital interactive 100-board on which the students could represent the problems to be solved by dragging counters. In the other study, the optional auxiliary tool consisted of a digital interactive number line. Both studies showed that the proportions of correct answers were higher in the ICT-based test than on the standardised test (Peltenburg et al. 2010). This result appears rather obvious, but for teachers a test that not only tells them which students got which problems correct, but also which students made use of the auxiliary tools and how they used them, contains very valuable indications for further instruction. In fact, in this way the zone of proximal development of the students is opened. Moreover, we found that the MLD students were quite aware of whether they needed the help of the auxiliary tools. Students who made the most mistakes in the later administered standardised test more often chose to use an auxiliary tool in the earlier administered ICT-based test.

As a result of these positive experiences with optional auxiliary tools, this approach to assessment is now being further explored in the EU-funded FaSMED project, which aims to research the use of technology in formative assessment classroom practices in ways that allow teachers to respond to the emerging needs of low-achieving students. The Dutch team of this project developed the Digital Assessment Environment (DAE) for mathematics education in the upper grades of primary school. Figure 16.1 shows an item on percentages with the optional auxiliary tools that can be chosen to solve this problem.

16.5 Conceptual Model-Based Problem-Solving: An Integration of Constructivist Mathematics Pedagogy and Explicit Strategy Instruction

Yan Ping Xin

The question whether students with learning disabilities should be educated in the inclusive classroom or in a segregated instructional environment has always been a hot topic. Here, I use the term ‘students with learning disabilities or difficulties in mathematics’ (LDM) to include all students whose mathematics performance is ranked below the 35th percentile (Bryant et al. 2011), so not necessarily only students with a biologically based disorder. With this broad definition in mind, a more pertinent question would be: ‘Do these children need a special kind of intervention or do they profit most from the same kind of instruction as children without LDM?’ In particular, ‘is conceptually-based and constructivist-oriented mathematics instruction also suitable for children with learning disabilities?’ For the most part, it depends on (a) how we support these students with instructional strategies that address their needs and (b) how much support or scaffolding we provide for these students so that they are able to make sense of the mathematical concept or relations or, from the instructional point of view, whether we can make the mathematical discourse or reasoning process explicit to the students so they can grasp the concept or knowledge. To this end, regardless of the placement, it is more important to consider whether the instructional strategies we employ will provide the needed support or scaffolding that will allow these students to have meaningful access to mathematics.

As the outcome of a collaborative piece of work that integrates research-based practices from math education and special education, Xin, Tzur and Si (2008), with the project team, have developed an intelligent tutor, PGBM-COMPS © (Xin, Tzur and Si 2017), to support the learning of multiplicative problem solving for students with LDM. The intelligent tutor draws on three research-based frameworks: a constructivist view of learning from mathematics education, data (or statistical) learning from computer science, and conceptual model-based problem solving (COMPS) (Xin 2012), from special education, that generalises word problem underlying structures. Rooted in a constructivist perspective on learning, we focused on how a student-adaptive teaching approach (Steffe 1990), which tailors goals and activities for students’ learning to their available conceptions, can foster advances in multiplicative reasoning. This approach is not based on a deficit view of students with learning disabilities; rather, it focuses on and begins from what they do know and uses task-based activities to foster transformation into advanced, more powerful ways of knowing.

The PGBM-COMPS tutor is made of two parts: (a) ‘Please Go Bring Me...’ (PGBM) turn-taking games designed to nurture a learner’s *construction* of fundamental ideas in multiplicative reasoning (Tzur et al. 2013) and (b) COMPS (Xin 2012) that emphasises understanding and representation of word problem structures in mathematical model equations. In particular, the PGBM turn-taking games were designed to nurture a learner’s *construction* of fundamental ideas such as ‘number as a composite unit’. A basic version of the PGBM platform game involves sending

a student to a box with Unifix Cubes to produce and bring back a tower made of a few cubes. After taking two-to-nine ‘trips’ for bringing same-sized towers, students are asked how many towers (i.e. composite units, CU) they brought, how many cubes each tower has (i.e. unit rate, UR) and how many cubes (1s) there are in all. The PGBM game was devised to promote learners’ anticipated creation of and differentiation among 1s and CUs (Tzur et al. 2013). These two anticipations are crucial if the learner is to construct the mental operation of multiplicative double counting, which is fundamental to multiplicative reasoning. Multiplicative double counting integrates two counting sequences in a multiplicative problem situation (e.g. ‘Please bring me a tower with 6 cubes in each.... If you brought me 5 such towers; how many cubes in all?’): one sequence that quantifies how many CUs (i.e. towers) were produced and one sequence that monitors the corresponding accumulation of 1s (i.e. total # of cubes) contained within those CUs (i.e. towers). Double counting is considered to be ‘an advance over the more basic direct representation because it requires more abstract processing’ (Kouba 1989, p. 152).

A variety of activities following a PGBM format were designed to promote students’ construction of basic multiplicative concepts on the basis of continuous assessment of their existing knowledge and experiences. The learner will progress from a low to high level of tasks along the dimensions of (a) numerical numbers (e.g. 2, 5 or 10 - level I; 3 or 4 - level II and 6, 7, 8 or 9 - level III) involved in the problem and (b) cognitive demands of the task (i.e. operating with visible objects or invisible/covered objects with mental system).

On the other hand, COMPS generalises the understanding of multiplicative reasoning to the level of mathematical models. At this stage, students no longer rely on concrete models (such as cubes and towers) or drawing pictures or tally marks; the mathematical models directly drive the solution plan. The COMPS programme emphasises (a) the connection between the PGBM games (in the contexts of cubes and towers for instance) and the symbolic mathematical model equations, (b) students’ representation of various multiplicative problem situations in the mathematical model equations and (c) development of the solution plan that is directly driven by the model equations. Figure 16.2 presents two sample screenshots from the PGBM-COMPS programme. The upper panel shows how the programme engages students in making the connection between the concrete modelling (cubes and towers) and the mathematical expression; the lower panel shows how the problem should be represented in the COMPS model to find a solution.

To evaluate the effect of the PGBM-COMPS © intelligent tutor, Xin et al. (2017) compared the effectiveness of the PGBM-COMPS programme with school teacher-delivered instruction (TDI) on enhancing the multiplicative reasoning and problem-solving skills of students with LDM. Results indicated that the improvement rate of the PGBM-COMPS group was much greater than that of the TDI group (effect size [ES] = 1.99 on researcher-developed multiplicative reasoning tasks; ES = 2.26 on a range of multiplication and division word problem-solving tasks involving large numbers). In addition, the group difference was shown on a commercial/published standardised test, the Stanford Achievement Test (SAT,

Please insert proper numbers and symbols for a multiplication equation:

6

×

3

=

18

of items in each unit
of units
of items in all units

Students in Mr. Green's class are organizing a total of 112 books onto shelves. If they put 28 books in each shelf, how many shelves will they need to put all the books?

28

×

a

=

112

Unit Rate
of Units
Product

Equation Box

28 × a = 112

Answer:

a =

Calculator

+ - × ÷

a = 112 ÷ 28 =

?

Help

Fig. 16.2 Sample screenshots of the PGBM-COMPS intelligent tutor system (Xin, Tzur and Si 2017)

Harcourt Assessment Inc. 2004): *Mathematics Problem Solving* subtest, favouring the COMPS group (ES = 1.23).

Given that the Common Core State Standards for Mathematics (National Council of Teachers of Mathematics 2012) demand much deeper content knowledge from teachers of mathematics, the preliminary findings of the above study are encouraging. The PGBM-COMPS intelligent tutor, which integrates the best practices from general mathematics education and special education, seems to yield better outcomes in enhancing participating students' multiplicative problem solving. Through the integration of heuristic instruction (that facilitates concept construction) and the explicit

model-based problem-solving instruction, it seems that the PGBM-COMPS programmes have promoted generalised problem-solving skills of students with LDM.

From the foregoing, here comes my answer to the question “whether conceptually based and constructivist-oriented mathematics instruction also suitable for children with learning disabilities? With appropriate scaffolding and support, students with LDM are able to engage in conceptually based and constructivist-oriented mathematics instruction. The promising outcome of the PGBM-COMPS intervention programme (Xin, Tzur and Si 2017) is just one example.

16.6 Discussion

Brian Butterworth

If you want to get ahead, get a theory.

Verschaffel raised two fundamental issues in his introductory remarks to the panel. First, he asks what constitutes the ‘mathematics’ that MLD should address. Here I would like to start with a very simple approach. What constitutes ‘a billable ICD-10-CM code that can be used to indicate a diagnosis for reimbursement purposes’? That is, what diagnosis will ensure that a child is entitled to special help for his or her mathematical difficulties? I take ICD 10 (The World Health Authorities list of diseases) because it is the clearest and most specific of the widely used classifications. In Sect. F81.2, the term used is a ‘specific disorder of arithmetical skills’. This ‘involves a specific impairment in arithmetical skills that is not solely explicable on the basis of general mental retardation or of inadequate schooling. The deficit concerns mastery of basic computational skills of addition, subtraction, multiplication, and division rather than of the more abstract mathematical skills involved in algebra, trigonometry, geometry, or calculus’. So, in this context, the answer to Verschaffel’s question is simple: *arithmetic*. However, there are problems.

Notice that the ICD definition excludes an impairment in arithmetical skills that is solely explicable on the basis of general mental retardation. That is, the child cannot be both stupid and have MLD. Moreover, it excludes, in a later paragraph, ‘arithmetical difficulties associated with a reading or spelling disorder’. Thus, the child cannot be both dyscalculic and dyslexic.

Spatial Abilities

ICD 10 does not mention spatial abilities, though it is known that, especially in the early years, there is a close link between them and arithmetical development (Rourke 1989). However, how this link operates is far from clear. Mulligan focuses on a specific set of spatial competences. In particular, she argues that a set of these underpins makes the conceptual relationships critical to arithmetical understanding. Specially designed interventions for weaknesses in this set of competences can make a big difference to the development of arithmetic.

‘Mental Retardation’

Mental retardation does not prevent high levels of mathematical skill. We know from the study of savants, with very low measured IQ or with other indicators of limited cognitive ability, that they can be superb calculators (Butterworth 2006). We also know that IQ measures are poor predictors of mathematical competence, such that even individuals with very high measured IQ can be dyscalculic (Butterworth et al. 2011). In an original approach to this issue, van den Heuvel-Panhuizen reported studies she had carried out on the mathematical abilities in schools for children with special educational needs. Now these children will have low scores on standard tests and would be classified as MLD but would be excluded from a ‘billable code’ because of their measured IQ. Now it may well be that these children can be drilled to perform moderately well on arithmetical problems, but the question addressed is much more interesting: do they have the conceptual basis and cognitive ability to develop their own valid strategies for calculation?

van den Heuvel-Panhuizen has a clear answer to this question. ‘What we found was that the MLD students, without being taught, made spontaneous use of the adding-on strategy. Moreover, they were rather flexible in what strategy they applied, and they were quite successful when applying the adding-on strategy.’ They were also ‘equally successful in solving the combinatorics problems’.

Verschaffel’s second issue is what is the appropriate intervention for children with special needs, and this raises the ICD 10 exclusion criterion – ‘inadequate schooling’. Now ICD 10 does not define this term, so it is not possible to determine whether the child is classified as MLD because of poor teaching. Baccaglini-Frank notes that this raises an important problem for the definition of MLD. She writes, ‘Insisting on the finding that persistent use of particular curricular materials can significantly reduce the number of children who are positive to diagnostic tests for *dyscalculia* in third grade, we find an apparent contradiction with literature claiming that *dyscalculia* is an *innate deficit*’. I will return to this point below.

She also notes, quite properly, that ‘if the classroom culture is heavily based on written language and the child has not overcome difficulties related to the use of this medium’, then this could cause the child to fall behind in maths. The child, she says, would be better served in a ‘special education classroom’. This would be another example of inadequate schooling.

Xin has developed an intelligent tutoring system designed to help all students with ‘learning disabilities or difficulties in mathematics’, by which she means students below the 35th percentile. For her, the nature of those difficulties, or their causes, appears not to be relevant. She argues that a conceptually based and constructivist-oriented mathematics instruction, developed for more typical students, is also suitable for children with learning disabilities. Her findings suggest that the intelligent tutoring system is more effective than teacher-delivered instruction.

A Theory-based Approach

At the root of the confusions about the criteria for MLD and about the appropriate intervention is the lack of theoretical perspective, and this is critical for understanding why a child fails to reach an expected level in maths.

Of course, what the expected level is will depend on social, economic and, importantly, political factors. One example is whether the educational authority – usually a government agency – recognises MLD as a ‘billable’ category. It may fail to do so out of ignorance, since mathematical competence is a proxy for intelligence or out of indolence, for example, if there is no parent pressure group to prod it into action. In the UK, and in many other countries, dyslexia is recognised precisely because there exist organisations that insist on its recognition. The authorities may not recognise MLD because it could entail a commitment to provide support for those assessed as MLD.

Without a theory, one is left with a criterion that could be set for economic or political reasons or could simply be arbitrary: 35th percentile, for example, or 1, 1.5, 2, 2.5 or 3 SDs below the population mean on a standardised test of arithmetic. None of these criteria tells you what the learner needs. The problem is compounded when one considers different populations. Consider an international comparison, for example, the PISA 2012 study. The proportion of children below level 2 in top ten countries was around 10%, but in the worst performing countries, it was between 60% and 75%. So what would count as MLD in Macao will be very different from what would count in Indonesia in terms of what the learner can and cannot do.

Here is the question that should be addressed: *why* is this child failing to understand what his or her classmates can understand? This is a theoretical question. For perhaps 5% of learners, the answer is that there is a deficit in very basic numerical concepts. That is, they will do poorly on tests that depend very little on the appropriateness of schooling or on social and economic status and even home background. These learners do poorly on tests of the enumeration of small sets of objects, typically displays of dots. They will be slower and less accurate than their peers, and this is a stable measure of individual difference and is a reliable predictor of the ease or difficulty of acquiring arithmetical competence (Reeve et al. 2012). Other very simple tests that rely little on education arrive at similar conclusions (Piazza et al. 2010). These are tests of a crucial component in the learner’s ‘starter kit’ for acquiring basic numerical competence that I have called ‘numerosity processing’ and means the ability to estimate the number of objects in a set. Poor performance on tests of this ability points to a congenital *core deficit* in numerosity processing. Not only is performance on these tests independent of schooling, it is independent of intelligence, of working memory and of literacy (Landerl et al. 2004). We call this special need ‘dyscalculia’.

The identification of a deficit in this core capacity has implications for intervention: more of the same, more slowly and with more repetition, does not work. As with dyslexia, specially designed interventions are needed, preferably using concrete materials, and adaptive digital games with virtual concrete materials, for much longer than would be needed with typically developing learners (Butterworth et al. 2011).

This approach also sheds light on the relationship between dyscalculia and other neurodevelopmental disorders. Dyslexia on this account cannot be a cause of dyscalculia, because it is due to a quite distinct core deficit, in most cases a phonological deficit (Butterworth and Kovas 2013; Landerl et al. 2009). This means that we must reject the ICD 10 exclusion criterion of reading disability and test for both core deficits.

Our approach also means that it is possible to have a core numerical deficit despite being highly intelligent, or indeed having low cognitive abilities. This is not to say that MLD may not have other causes, including inadequate schooling (an international problem), prematurity, poor diet and a difficult home environment (Benavides-Varela et al. 2016). In these cases, a different approach to intervention will be needed. In mathematical education, as in so many other things, one size does not fit all. Measure the customer first and then find the garment that fits best.

References

- Ansari, D. (2008). Effects of development and enculturation on number representation in the brain. *Nature reviews. Neuroscience*, 9, 278–291.
- Baccaglioni-Frank, A., & Scorza, M. (2013). Preventing learning difficulties in early arithmetic: The PerContare project. In T. Ramiro-Sánchez & M. P. Bermúdez (Eds.), *Libro de Actas I Congreso Internacional de Ciencias de la Educación y des Desarrollo* (p. 341). Granada: Universidad de Granada.
- Baccaglioni-Frank, A. E., & Bartolini Bussi, M. G. (2015). Buone pratiche didattiche per prevenire falsi positivi nelle diagnosi di discalculia: il progetto “PerContare”. *Form@re – Open Journal per la formazione in rete*, [S.l.], 15(3), 170–184.
- Bartolini Bussi, M. G., & Mariotti, M. A. (2008). Semiotic mediation in the mathematics classroom: Artifacts and signs after a Vygotskian perspective. In L. English, M. Bartolini Bussi, G. Jones, R. Lesh, & D. Tirosh (Eds.), *Handbook of international research in mathematics education* (2nd revised edn) (pp. 746–805). Mahwah: Lawrence Erlbaum Associates.
- Benavides-Varela, S., Butterworth, B., Burgio, F., Arcara, G., Lucangeli, D., & Semenza, C. (2016). Numerical activities and information learned at home link to the exact numeracy skills in 5–6 years-old children. *Frontiers in Psychology*, 7(94).
- Berch, D. B., & Mazzocco, M. M. M. (2007). *Why is math so hard for some children? The nature and origins of mathematical learning difficulties and disabilities*. Baltimore: Paul H. Brookes Publishing.
- Bryant, D. P., Bryant, B. R., Roberts, G., Vaughn, S., Pfannenstiel, K. H., Porterfield, J., & Gersten, R. (2011). Early numeracy intervention program for first-grade students with mathematics difficulties. *Exceptional Children*, 78, 7–23.
- Butterworth, B. (2005). Developmental dyscalculia. In J. I. D. Campbell (Ed.), *Handbook of mathematical cognition* (pp. 455–467). Hove: Psychology Press.
- Butterworth, B. (2006). Mathematical expertise. In K. A. Ericsson, N. Charness, P. J. Feltovich, & R. R. Hoffmann (Eds.), *Cambridge handbook of expertise and expert performance* (pp. 553–568). Cambridge: Cambridge University Press.
- Butterworth, B., & Kovas, Y. (2013). Understanding neurocognitive developmental disorders can improve education for all. *Science*, 340, 300–305.

- Butterworth, B., Varma, S., & Laurillard, D. (2011). Dyscalculia: From brain to education. *Science*, 332, 1049–1053.
- Clements, D. H., & Sarama, J. (2011). Early childhood teacher education: The case of geometry. *Journal of Mathematics Teacher Education*, 14(2), 133–148.
- Davis, B. (Ed.). (2015). *Spatial reasoning in the early years: Principles, assertions, and speculations*. New York: Routledge.
- De Smedt, B., Noël, M. P., Gilmore, C., & Ansari, D. (2013). The relationship between symbolic and non-symbolic numerical magnitude processing and the typical and atypical development of mathematics: A review of evidence from brain and behavior. *Trends in Neuroscience and Education*, 2, 48–55.
- Dehaene, S. (2009). *Reading in the brain: The science and evolution of a human invention*. New York: Penguin Viking.
- Dowker, A. (2008). *Mathematical difficulties: Psychology and intervention*. Amsterdam: Elsevier/Academic.
- Fias, W., & Fischer, M. H. (2005). Spatial representation of numbers. In J. I. D. Campbell (Ed.), *Handbook of mathematical cognition* (pp. 43–54). Hove: Psychology Press.
- Gallese, V., & Lakoff, G. (2005). The brain's concepts: The role of the sensory-motor system in conceptual knowledge. *Cognitive Neuropsychology*, 22, 455–479.
- Gelderblom, G. (2008). *Effectief omgaan met zwakke rekenaars* [Effectively working with students who are weak in mathematics]. Amersfoort: CPS.
- Hannula, M. M., & Lehtinen, E. (2005). Spontaneous focusing on numerosity and mathematical skills of young children. *Learning and Instruction*, 15, 237–256.
- Harcourt Assessment Inc. (2004). *Stanford Achievement Test series: Tenth edition technical data report*. San Antonio: Author.
- Hord, C., & Xin, Y. P. (2015). Teaching area and volume to students with mild intellectual disability. *The Journal of Special Education*, 49(2), 118–128.
- Karagiannakis, G., & Baccaglioni-Frank, A. (2014). The DeDiMa battery: A tool for identifying students' mathematical learning profiles. *Health Psychology Review*, 2(4), 291–297.
- Karagiannakis, G., Baccaglioni-Frank, A., & Papadatos, Y. (2014). Mathematical learning difficulties subtypes classification. *Frontiers in Human Neuroscience*, 8(57).
- Karagiannakis, G., Baccaglioni-Frank, A., & Roussos, P. (2018). Detecting difficulties in learning mathematics through a model-driven experimental battery. *The Australian Journal of Learning Difficulties*, 23(1), 115–141.
- Kouba, V. L. (1989). Children's solution strategies for equivalent set multiplication and division word problems. *Journal for Research in Mathematics Education*, 20(2), 147–158.
- Landerl, K., Bevan, A., & Butterworth, B. (2004). Developmental dyscalculia and basic numerical capacities: A study of 8–9-year-old students. *Cognition*, 93, 99–125.
- Landerl, K., Fussenegger, B., Moll, K., & Willburger, E. (2009). Dyslexia and dyscalculia: Two learning disorders with different cognitive profiles. *Journal of Experimental Child Psychology*, 103, 309–324.
- Mazzocco, M. M. M., & Räsänen, P. (2013). Contributions of longitudinal studies to evolving definitions and knowledge of developmental dyscalculia. *Trends in Neuroscience and Education*, 2(2), 65–73.
- McDonald, B. (2015). Ben's perception of space and subitizing activity: A constructivist teaching experiment. *Mathematics Education Research Journal*, 27(4), 563–584.
- Mulligan, J. T. (2011). Towards understanding the origins of children's difficulties in mathematics learning. *Australian Journal of Learning Difficulties*, 16(1), 19–39.
- Mulligan, J. T., English, L. D., Mitchelmore, M. C., & Crevensten, N. (2013). Reconceptualising early mathematics learning: The fundamental role of pattern and structure. In L. D. English & J. T. Mulligan (Eds.), *Reconceptualizing early mathematics learning* (pp. 47–66). New York: Springer.

- Mulligan, J. T., Mitchelmore, M. C., & Stephanou, A. (2015). *Pattern and Structure Assessment (PASA): An assessment program for early mathematics (years F-2) teacher guide*. Melbourne: ACER Press.
- National Council of Teachers of Mathematics. (2012). *Common core state standards for mathematics*. Reston: National Council of Teachers of Mathematics.
- Papic, M. M., Mulligan, J. T., & Mitchelmore, M. C. (2011). Assessing the development of preschoolers' mathematical patterning. *Journal for Research in Mathematics Education*, 42(3), 237–268.
- Peltenburg, M. (2012). *Mathematical potential of special education students*. PhD thesis, Utrecht University.
- Peltenburg, M., van den Heuvel-Panhuizen, M., & Robitzsch, A. (2010). ICT-based dynamic assessment to reveal special education students' potential in mathematics. *Research Papers in Education*, 25, 319–334.
- Peltenburg, M., van den Heuvel-Panhuizen, M., & Robitzsch, A. (2012). Special education students' use of indirect addition in solving subtraction problems up to 100: A proof of the didactical potential of an ignored procedure. *Educational Studies in Mathematics*, 79(3), 351–369.
- Peltenburg, M., van den Heuvel-Panhuizen, M., & Robitzsch, A. (2013). Special education students' strategies in solving elementary combinatorics problems. In A. M. Lindmeier & A. Heinze (Eds.), *Proceedings of the 37th PME conference* (Vol. 4, pp. 17–24). Kiel: PME.
- Piazza, M., Facoetti, A., Trussardi, A. N., Berteletti, I., Conte, S., Lucangeli, D., et al. (2010). Developmental trajectory of number acuity reveals a severe impairment in developmental dyscalculia. *Cognition*, 116, 33–41.
- Reeve, R., Reynolds, F., Humberstone, J., & Butterworth, B. (2012). Stability and change in markers of core numerical competencies. *Journal of Experimental Psychology: General*, 141, 649–666.
- Rourke, B. P. (1989). *Nonverbal learning disabilities: The syndrome and the model*. New York: Guilford.
- Starkey, G. S., & McCandliss, B. D. (2014). The emergence of “groupitizing” in children's numerical cognition. *Journal of Experimental Child Psychology*, 126, 120–137.
- Steffe, L. P. (1990). Adaptive mathematics teaching. In T. J. Cooney & C. R. Hirsch (Eds.), *Teaching and learning mathematics in the 1990s* (pp. 41–51). Reston: National Council of Teachers of Mathematics.
- Tzur, R., Johnson, H. L., McClintock, E., Kenney, R. H., Xin, Y. P., Si, L., Woodward, J., Hord, C. T., & Jin, X. (2013). Distinguishing schemes and tasks in children's development of multiplicative reasoning. *PNA: Revista de Investigación en Didáctica de la Matemática*, 7(3), 85–101.
- van den Heuvel-Panhuizen, M. (1986). Het rekenonderwijs op de lom-school opnieuw ter discussie [Mathematics education in special education again up for debate]. *Tijdschrift voor Orthopedagogiek*, 25, 137–145.
- van den Heuvel-Panhuizen, M. (1996). A test on ratio: What a paper-and-pencil test can tell about the mathematical abilities of special education students. In M. van den Heuvel-Panhuizen (Ed.), *Assessment and realistic mathematics education* (pp. 233–255). Utrecht: CD-B Press, Utrecht University.
- Verdine, B., Chang, A., Filipowicz, A. T., Golinkoff, R. M., Hirsh-Pasek, K., & Newcombe, N. S. (2014). Deconstructing building blocks: Preschoolers' spatial assembly performance relates to early mathematics skills. *Child Development*, 85, 1062–1076.
- Woolcott, G., Chamberlain, D., & Mulligan, J. (2015). Using network analysis to connect structural relationships in early mathematics assessment. In K. Beswick, T. Muir, & J. Wells (Eds.), *Proceedings of the 39th conference of the International Group for the Psychology of Mathematics Education* (Vol. 4, pp. 321–328). Hobart: PME.
- Xin, Y. P. (2012). *Conceptual model-based problem solving: Teach students with learning difficulties to solve math problems*. Rotterdam: Sense Publishers.
- Xin, Y. P., & Hord, C. (2013). Conceptual model based teaching to facilitate geometry learning of students who struggle in mathematics. *Journal of Scholastic Inquiry: Education*, 1, 147–160.

- Xin, Y. P., Liu, J., Jones, S., Tzur, R., & Luo, S. I. (2016). A preliminary discourse analysis of constructivist-oriented math instruction for a student with learning disabilities. *The Journal of Educational Research*, 109(4), 436–447.
- Xin, Y. P., Tzur, R., & Si, L. (2017). *Nurturing multiplicative reasoning in students with learning disabilities in a computerized conceptual-modeling environment*. West Lafayette: Purdue University.
- Xin, Y. P., Tzur, R., & Sin, L. (2017a). *PGMB-COMPS© Math World Problem Solving Intelligent Tutor*. West Lafayette: Purdue Research Foundation, Purdue University.
- Xin, Y. P., Tzur, R., Sin L., Hord C., Liu J., & Park, J. V. (2017b). An intelligent tutor-assisted math problem solving intervention program for students with *learning difficulties*. *Learning Disabilities Quarterly*, 40(1), 4–16

Cited papers from Sun, X., Kaur, B., & Novotna, J. (Eds.). (2015). Conference proceedings of the ICMI study 23: Primary mathematics study on whole numbers. Retrieved February 10, 2016, from www.umac.mo/fed/ICMI23/doc/Proceedings_ICMI_STUDY_23_final.pdf

- Baccaglioni-Frank, A. (2015). Preventing low achievement in arithmetic through the didactical materials of the PerContare project (pp. 169–176).

Open Access This chapter is licensed under the terms of the Creative Commons Attribution 4.0 International License (<http://creativecommons.org/licenses/by/4.0/>), which permits use, sharing, adaptation, distribution and reproduction in any medium or format, as long as you give appropriate credit to the original author(s) and the source, provide a link to the Creative Commons license and indicate if changes were made.









The images or other third party material in this chapter are included in the chapter's Creative Commons license, unless indicated otherwise in a credit line to the material. If material is not included in the chapter's Creative Commons license and your intended use is not permitted by statutory regulation or exceeds the permitted use, you will need to obtain permission directly from the copyright holder.



Chapter 17

Professional Development Models for Whole Number Arithmetic in Primary Mathematics Teacher Education: A Cross-Cultural Overview



Jarmila Novotná ,
Maria G. Bartolini Bussi , Sybilla Beckmann , Maitree Inprasitha ,
Berinderjeet Kaur , Xu Hua Sun , Hamsa Venkat , and Mike Askew 

17.1 General Introduction¹

Jarmila Novotná

This chapter proceeds from the plenary panel on teacher education presented at the ICMI Study 23 conference in Macao (Novotná 2015). The main goal of the panel, as well as of this chapter, was to explore approaches to, and within, primary mathematics teacher education in different parts of the world and to discuss commonalities and differences in relation to broader cultural and curricular traditions.

¹The paper was supported by the project Progres Q17 Příprava učitele a učitelská profese v kontextu vědy a výzkumu (Teacher preparation and teaching profession in the context of science and research).

J. Novotná (✉)

Charles University, Prague, Czech Republic, and Laboratoire “Culture et Diffusion des Savoirs”, Université de Bordeaux, Bordeaux, France
e-mail: jarmila.novotna@pedf.cuni.cz

M.G. Bartolini Bussi

Department of Education and Humanities, University of Modena and Reggio Emilia, Modena, Italy

S. Beckmann

University of Georgia, Athens, GA, USA

M. Inprasitha

Khon Kaen University, Khon Kaen, Thailand

The ICMI Study 23 was focused on the mathematical domain of WNA. There is broad agreement that deep understanding of school mathematics in general, and WNA in particular (for primary teachers), is critical. It follows from this that WNA provides a critical context for developing understandings and constructing arguments that adhere to the practices and norms of more advanced mathematics. One thrust of this chapter is to present and discuss examples from several parts of the world that approach this theme through a focus on primary mathematics teacher education on developing, discussing and applying mathematical models. But this thrust is set within the broader terms of different curricular approaches to WNA in different countries and regions and different cultures and structures regulating the ways in which primary mathematics teacher education (and primary teacher education more generally) is organised. In this broader curricular and cultural terrain, we take up two issues specifically. In the curricular approaches to WNA, we take up the issue of two ways of thinking about early number – in terms of length or location on a number line (where ordinality can be more emphasised, alongside cardinality) versus in terms of base ten structure (where place value structure and relationships can be more emphasised, alongside cardinality) – and use specific examples to point to number being presented in different ways in different countries. Secondly, we take up an issue that emerged from looking at the foci of different presentations at the ICMI Study 23 conference with antecedents in prior writing: of more individualist, decentralised and autonomous cultures and views of teacher learning versus more collective and centralised views of teacher learning. These latter differences have consequences for the models of teacher education that are possible in different contexts and for the ways in which teacher education is structured within the timetables of schooling.

In this chapter, we begin our discussion in the terrain of cultures associated with teacher education, before moving into curricular approaches to WNA. Key models for teacher education are then introduced and discussed to exemplify key contrasts. We then move into the detail of mathematical models that have been used within primary mathematics teacher education and use these examples to highlight attention to differences relating to length (i.e. models focusing on the ordinal aspects of number) and base ten structure (focusing on the cardinal aspects), as well as the

B. Kaur

National Institute of Education, Nanyang Technological University, Singapore, Singapore

X.H. Sun

Faculty of Education, University of Macau, Macao, China

H. Venkat

University of the Witwatersrand, Johannesburg, South Africa

M. Askew (discussant)

University of the Witwatersrand, Johannesburg, South Africa, and Monash University, Melbourne, Victoria, Australia

broader organisation of teacher education across these contexts. The key questions that we address in this chapter can therefore be summarised thus:

- What broad similarities and differences can be seen in relation to cultural views of primary teacher learning in different parts of the world? How do these differences play out in models of primary teacher development?
- What are the key differences between curricular approaches that foreground more ordinal versus place value structural relations views of early number?
- What key mathematical models are promoted in primary mathematics teacher development in different parts of the world? How do cultural and curricular differences play out within these mathematical models and the professional development models of primary mathematics development that these mathematical models are couched within?

The panel consisted of six scholars representing different parts of the world, complemented by two discussants. All of them have rich experience with mathematics teacher education in their countries/regions. The panellists were (in alphabetical order) Maria G. Bartolini Bussi (University of Modena and Reggio Emilia, Italy), Sybilla Beckmann (University of Georgia, USA), Maitree Inprasitha (Khon Kaen University, Thailand), Berinderjeet Kaur (National Institute for Education, Singapore), Xu Hua Sun (University of Macau, China) and Hamsa Venkat (University of the Witwatersrand, South Africa). The discussants were Deborah Loewenberg Ball (University of Michigan, USA) and Mike Askew (University of the Witwatersrand, South Africa).

17.2 Cultural Views of Primary Teacher Learning and WNA

Jarmila Novotná and Hamsa Venkat

Alexander (2009) proposes a view of pedagogy as profoundly cultural, while at the same time, exhibiting some continuities that appear to transcend place and time:

pedagogy does not begin and end in the classroom. It is comprehended only once one locates practice within the concentric circles of local and national, and of classroom, school, system and state, and only if one steers constantly back and forth between these, exploring the way that what teachers and students do in classrooms reflects the values of the wider society. (p. 924)

It follows from this that examining teacher development in the context of WNA also entails attention to broader curricular and cultural ideologies, in order to more completely understand their contents and approaches to supporting primary mathematics teaching.

Some broad differences in the emphasis of mathematics education research between the East and West have been noted in the papers presented in this ICMI study and in prior work. For example, Ma (1999) has noted the central role, and

study by teachers, of carefully developed, standardised textbooks in Chinese primary mathematics education. This contrasts with a much more critical view of the standardisations inherent in textbook sequences, sometimes set within a broader culture that celebrates and emphasises the varied individualism of children's interests, understandings and learning pathways (Triandis and Trafimow 2001) and which was prevalent in much of the literature on the need for learner-centred education.

Moving into the terrain of WNA, Sun et al. (2013), comparing the ways in which addition and subtraction are presented in Chinese and Portuguese textbooks, noted the central role of textbooks in the Chinese professional education of teachers. They point to carefully varied sets of problems in which structural similarities of part-whole relations are at the fore and combinations of and with ten are collectively viewed as the key conceptual idea to be foregrounded in order for these ideas to become problem-solving tools for working with subsequent mathematical content. In base ten-oriented models of number, stick bundles or Dienes block-type manipulatives, triad diagrams representing a whole with its constituent parts and symbolic number sentences are commonly juxtaposed. Length- and location-based models using the number line predominate in early number tasks in the Portuguese textbooks in focus in this study, emphasising the direction and extent of motion associated with operations and quantities. There is less overt connection between addition and subtraction in the early examples shown in the Portuguese textbooks, with later work pointing to these as operations connected through the idea of inverse operations. Of interest is that while multiple methods are expected and promoted in the Chinese textbooks, all of these depend on ideas of decomposition, with specific selections often based around decimal structure. Beishuizen's (1993) emphasis on using number line models with compensatory steps as important higher-level efficiency moves, e.g. solving $65 - 38$ with a jump backwards of 40 and a compensatory forward jump of 2, tends not to feature in the Chinese approach. The forward trajectories in the Chinese approach are seen as preparation for the focus on structure and relations needed for algebraic working, as well as for the decimal number structure. In contrast, the Realistic Mathematics Education approach emphasises the number line model as having strong associations backwards into counting and forwards into models and methods in the real number terrain (Anghileri 2006). These differences in goals and trajectories within the WNA context can be seen more broadly in the contrasts drawn between counting-based and structure-based approaches to early number (see for example Schmittau 2003).

Bartolini Bussi and Martignone (2013) have also pointed out the ways in which both mathematical models and structures had to be adapted in schooling in order to explore the 'transposition' of models beyond the ground of their cultural origins. The broader point we can make based on the ICMI study contributions is that some national traditions, more than others, foreground studies in which there is a broad focus on teaching and particular pedagogic tools and how such tools have both been developed and refined over the years. In these traditions, there are indications of greater homogeneity and 'taken as shared' views of both trajectories of mathematical content and approaches to support its learning. Backgrounded in these papers

from the ICMI Study 23 Proceedings was how teachers subsequently work with and make sense of such tools, with this occurrence perhaps reflecting the expectation of buy-in to the theories and models being promulgated, rendering a study of differences in take up less culturally normal.

The foci in these papers stand in stark contrast to those written by authors with a more typically 'Western' sensibility. For example, Askew (2015) presented a case study of a teacher in South Africa, focusing on how, in a lesson on place value, the teacher's actions, representations and discourse achieved coherence and connections. Similarly, Tempier (2013), cited in Chambris (2015), explores overlaps and contrasts in three teachers' handling of place values ideas in France, and Venenciano et al. (2015) present detailed excerpts of a teaching approach designed to support children's appropriation of ideas of unit and structural relations between units. While cardinality and place-value relations are at the fore of these studies, we draw attention to these studies here because of their common focus on to the ways in which mathematical ideas are taken up within teaching and learning.

This brief overview of culture and WNA models and approaches feeds into the range of cases that we present below dealing both with models of teacher education and mathematical models of WNA in teacher education. In some of these contexts, the professional development and mathematical models have broad cultural and historical support and are often accompanied by systemic sanction in the form of structural support for their take up in teacher development. In other countries, the cases reflect take up of approaches and models in more local initiatives, often accompanied by the need to build structural affordances for supporting take up. In each of the cases that follow, we provide an overview of the national/provincial context in relation to the extent of standardisation of curricula/textbooks and the structure of teacher education, with this data gathered from contributing authors, prior studies and the context forms that were collected with submissions for the ICMI 23 Study conference.

All themes dealt with during the ICMI Study 23 conference and in the volume are deeply linked with teacher education and development. This was both intentional and a natural property of the whole WNA domain. In the discussion document for the study conference, one of the basic questions was: how can each of the themes be effectively addressed in teacher education and professional development? In order to teach elementary mathematics effectively, there is a need for sound professional knowledge, both in mathematics and in pedagogy. In Theme 1 ('The why and what of whole number arithmetic'), the topic was explored from the perspective of teachers' mathematical content knowledge. Theme 2 ('Whole number thinking, learning and development') addressed cognitive aspects of WNA with attention paid to, among other aspects, integrating different perspectives into a more coherent view with consequences for teacher education and development. In Theme 3 ('Aspects that affect whole number learning'), teacher education played a central role and included examples of impact of the topic in teacher education and development (Canada and Thailand). In Theme 4 ('How to teach and assess whole number arithmetic'), teacher education and development were present explicitly or implicitly in all contributions, including examples of various pedagogic approaches, text-

book organisation and used artefacts and a broader study explicitly acknowledging teachers' didactical or pedagogical knowledge and noting that neither teachers' extent of teaching experience nor their teacher education accounted for observed differences. Theme 5 ('Whole numbers and connections with other parts of mathematics') included the study of avenues through which whole number arithmetic learning might be supported in teacher education.

17.3 Primary Teacher Education Across the World

17.3.1 US Experience²

Sybilla Beckmann

17.3.1.1 Organisation of Primary Teacher Education in the USA

General or local organisation: Primary teacher education is developed locally. Each state has its own guidelines or regulations for the preparation, certification and licensing of teachers. However, there are influential non-governmental accrediting bodies that operate nationally and issue standards for teacher education.

Teacher qualification: Primary teachers are usually generalists although there is growing interest in building specialist development.

Curriculum for primary mathematics: There is no national curriculum. Since 2010, the Common Core State Standards for Mathematics have been adopted by most states.

17.3.1.2 Key Questions About Teacher Knowledge in the USA

A key concern in the mathematical education of primary and middle-grade teachers in the USA is how teachers can further their own disciplinary knowledge of mathematics while also studying deeply the mathematics that they will teach. According to a report issued jointly by national mathematical societies in the USA (Conference Board of the Mathematical Sciences 2012), teachers should know the mathematical topics they will teach and how these topics connect to others in earlier and later grades. Teachers should also know the ways of reasoning and constructing arguments in mathematics, how these ways of reasoning and argumentation apply at the elementary level and how to teach these ways reasoning and argumentation to students.

²Research was supported by the National Science Foundation under Grant No. DRL-1420307. The opinions expressed are those of the author and do not necessarily reflect the views of the NSF.

In the USA, the *Common Core State Standards for Mathematics* document (Common Core State Standards Initiative 2010), which has been adopted by most states, describes standards for mathematical practice for students in kindergarten through Grade 12. In particular, according to these standards, mathematically proficient students should be able to understand and use stated assumptions, definitions and previously established results in constructing arguments, and they should try to use clear definitions in discussion with others and in their own reasoning. Therefore even students in elementary school are expected to understand suitable definitions and use them in explaining and arguing for the validity of mathematical statements.

Several aspects of definition have been studied in mathematics education research including the distinction for students and teachers between concept image and concept definition (Edwards and Ward 2004; Tall and Vinner 1981; Tsamir et al. 2015; Vinner 1991), students' and teachers' conceptions of definition and their understanding of definitions and alternate definitions for a given concept (Zaslavsky and Shir 2005; Zazkis and Leikin 2008), students' difficulties in using definitions the way mathematicians do (Edwards and Ward 2004) and how to lay a foundation for understanding definitions (Bartolini Bussi and Baccaglioni-Frank 2015). Throughout, there is special concern about teachers' knowledge of definitions and the role of definitions in mathematics.

Research in mathematics education has considered definitions mainly within geometry (e.g. definitions of shapes, such as squares and rectangles) and topics related to functions (e.g. limits). However, there is a clear need to use definitions within other mathematical domains. For example, how could a student construct a mathematical argument demonstrating that $1/2 \cdot 1/3$ is equal to $1/6$ without definitions for multiplication and fractions? Careful mathematical arguments should appeal to definitions of multiplication and fractions rather than leaving those definitions implicit.

Beckmann and Izsák (2015) defined multiplication, $M \cdot N = P$, for non-negative quantities M , N and P by interpreting the multiplier, M , as a number of equal groups; the multiplicand, N , as a number of units in 1 (or each) group; and the product, P , as the number of units in M groups. They argued that this quantitative definition of multiplication organises not only multiplication and division, but also proportional and inversely proportional relationships between covarying quantities. Thus, the multiplicative conceptual field (e.g. Vergnaud 1988), which encompasses multiplication, division, fraction, ratio and proportion, and is a foundation for such critical topics as linear functions, rates of change and slope, should be an excellent domain in which to hone the skill of arguing from a definition.

Preliminary results of Beckmann et al. (2015) indicate that future middle-grade teachers can construct viable arguments to devise solutions to missing-value proportion problems using the quantitative definition of multiplication. In their study, future teachers were also asked to generate equations in two variables to relate quantities covarying in a proportional relationship. On a written test, the teachers were given a scenario in which a type of fertiliser was made by mixing nitrogen and

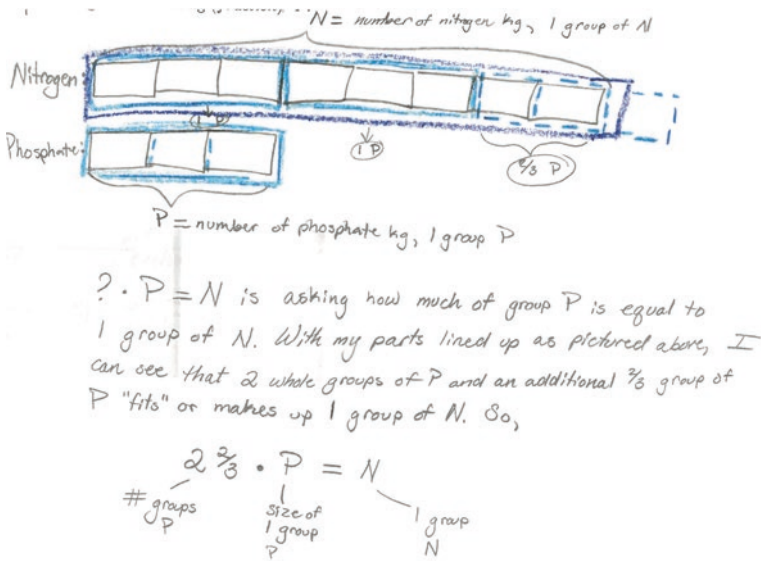

Fig. 17.1 Using a definition of multiplication and a strip diagram to explain an equation

phosphate in an 8 to 3 ratio and asked to use math drawings and the definition of multiplication to generate and explain an equation of the form:

$$(\text{fraction}) \cdot P = N$$

given that N and P are unspecified numbers of kilogrammes of nitrogen and phosphate, which could vary. Figure 17.1 shows part of one teacher’s explanation. The drawing indicates that the teacher views the nitrogen as consisting of eight parts, which encompass a total of N kilogrammes or one group of N , and views the phosphate as consisting of three parts, which encompass a total of P kilogrammes or one group of P . The teacher formulates the equation:

$$? \cdot P = N$$

and interprets it as ‘asking how much of group P is in 1 group of N ’. From the drawing, the teacher deduces that the answer is $2 \frac{2}{3}$ because ‘2 whole groups of P and an additional $\frac{2}{3}$ group of P “fits” or makes up 1 group of N ’, thus concluding with the equation $2 \frac{2}{3} \cdot P = N$.

Notice how the teacher uses the definition as an organisational framework for a coherent mathematical argument. In the given problem, the goal is to explain a linear equation in two variables. Because the coefficient (the multiplier) in that equation is not given, it must be found. The teacher uses the definition of multiplication as a vehicle for finding the coefficient. To do so requires that the teacher think about one quantity flexibly in multiple ways: she views the phosphate simultaneously as P

kilogrammes, as one group of P and as three parts. Thus, the definition of multiplication may function not only as an organising framework, but also as a vehicle for thinking more deeply about coordinating the fixed and varying aspects of quantities.

The teacher's argument relies critically on her drawing in Fig. 17.1. This drawing is an example of a strip diagram, also known as a tape diagram, which is one kind of diagram or 'math drawing' that Beckmann and Izsák (2015) presented in explaining how a quantitative definition of multiplication applies to interpreting and reasoning about proportional relationships between covarying quantities. These math drawings represent quantities with lengths and show relationships between quantities. For example, a longer length implies a greater quantity; a length that is three times as long as another implies one quantity is three times the other. Strip diagrams are also the representation used in the model method, which has been used effectively in Singapore with primary students studying whole number arithmetic (Kaur 2015).

In mathematics, definitions have a scientific function rather than an everyday one. Definitions provide technical power – they 'have the potential of saving you from many traps which are set by the concept image' (Vinner 1991, p. 69). But to use definitions, they must be understandable to students while also being mathematically accurate. Representations may be a key tool that helps students and teachers use definitions in constructing mathematical arguments. Representations may be even more important in teacher education. As argued by Venkat (2015, p. 587), 'attention to representational competence can provide a bridge that allows for concurrent attention to teachers' learning of mathematics and their teaching of mathematics'.

17.3.2 Singapore: The Model Method

Berinderjeet Kaur

17.3.2.1 Organisation of Primary Teacher Education in Singapore

General or local organisation: There are common teacher education standards as all the teachers are trained in the sole teacher education institute in Singapore.

Teacher qualification: Generalists.

Curriculum for primary mathematics: There is a common national curriculum developed by mathematics curriculum specialists at the Ministry of Education and revised periodically so that it remains relevant.

2-Part Word Problems

See and Learn 

1 Ramli has 265 strawberries and 184 mangoes.

(a) How many fruits does he have altogether?
 (b) How many fewer mangoes than strawberries does he have?



(a)

265	184
strawberries	mangoes
?	

$265 + 184 = 449$

He has 449 fruits altogether.

	H	T	O
	12	6	5
+	1	8	4
	4	4	9

(b)

	265
strawberries	mangoes
184	?

$265 - 184 = 81$

He has 81 fewer mangoes than strawberries.

	H	T	O
	12	6	5
-	1	8	4
		8	1

Fig. 17.2 Use of models to solve a two-part word problem (Chan and Cole 2013a, p. 4)

17.3.2.2 Examples

The primary school mathematics curriculum in Singapore places emphasis on quantitative relationships when students learn the concepts of number and the four operations. The model method (Kho 1987), an innovation in the teaching and learning of primary school mathematics, was developed by the primary school mathematics project team at the Curriculum Development Institute of Singapore in the 1980s. The method, a tool for representing and visualising relationships, is a key heuristic students' use for solving whole number arithmetic (WNA) word problems.

The concrete-pictorial-abstract (CPA) approach of the primary school mathematics curriculum in Singapore is congruent with the concepts of the part-whole and comparison models. In the CPA approach, students make use of concrete objects, while in the model approach they draw rectangular bars to represent the concrete

Fig. 17.3 Implicit introduction of the part-part-whole concept in Grade 1 (Chan and Cole 2013b, p. 27)

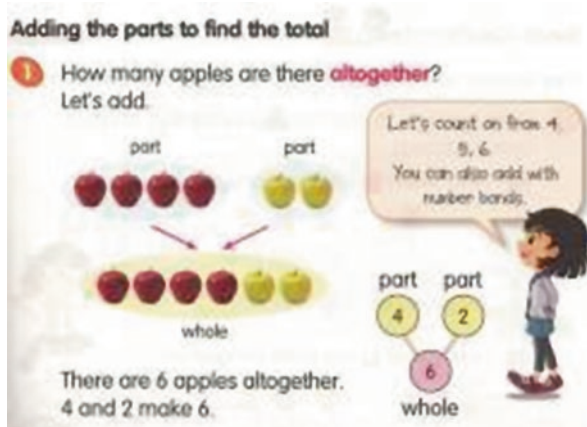

objects. The rationale for the choice of rectangular bars is that they are relatively easy to partition into smaller units when necessary compared with other shapes.

The part-whole model illustrates a situation where the whole is composed of two or more parts. When the parts are given, the students can determine the whole. Sometimes the whole and some parts are given and other parts are unknown. The comparison model demonstrates the relationship between two or more quantities when they are compared, contrasted or described in terms of differences.

When students make representations using the part-whole (shown in Fig. 17.2 – part a) and comparison models (shown in Fig. 17.2 – part b), the problem structure emerges and students are able to visualise the relationship between the known and unknown and determine what operation to use and solve the problem.

17.3.2.3 Primary School Mathematics Textbooks Used in Singapore Schools

Textbooks used in Singapore schools must be approved by the Ministry of Education. In addition, textbook writers work very closely with the Ministry of Education Mathematics specialists when writing the books. Therefore it may be said that textbooks are vehicles for the intended curriculum prescribed by the Ministry of Education. Teacher guides accompanying the textbooks make explicit the pedagogy the textbooks support. A significant pedagogical strategy is the model method (Ministry of Education 2009). It is introduced in the textbooks from Grade 1 onwards. Figures 17.3 and 17.4 illustrate how the idea of models is implicitly and explicitly introduced in Grades 1 and 2 respectively.

Word Problems

See and Learn

1-step word problems

1 Suresh has 14 coins.
Jason has 9 coins.
How many coins do they have altogether?

We can use cubes or draw a model to show the number of coins.

$14 + 9 = 23$

They have 23 coins altogether.

What does the yellow bar show?
What does the green bar show?

Fig. 17.4 Explicit introduction of part-part-whole models in Grade 2 (Chan and Cole 2013c, p. 52)

17.3.2.4 Preparation of Primary School Mathematics Teachers to Teach the Model Method

Prospective primary school mathematics teachers are introduced to the model method as part of their curriculum studies (mathematics) during their pre-service teacher education at the National Institute of Education in Singapore. As part of their pre-service course work, they use textbooks that are approved by the Ministry of Education which adopt the method of models as a pedagogical strategy for the learning of mathematics. Since the method has been used widely in Singapore schools from the 1980s, many of the prospective teachers since the late 1990s are very familiar with the strategy as they themselves used it to solve problems in their primary school days.

17.3.2.5 What Does Research Say About the Effectiveness of the Model Method?

The model method has proved to be effective for building number sense and solving arithmetic word problems in Singapore schools. A rigorous study by Ng and Lee (2009) of the model method clarified that the method engages students in capturing the inputs, the relationships between the inputs and the output of the problem. Once students have constructed a model, they use it ‘to plan and develop a sequence of logical statements, which allows for the solution of the problem’ (p. 291). Their study also noted that ‘average ability children’s solution of word problems involving whole numbers could be improved if they learn to exercise more care in the construction of related models’ (p. 311).

However, when very challenging questions are posed, in Grades 5 and 6 such as the following:

Mr Lim had a total of 540 long and short rulers. After selling an equal number of both types, he had $\frac{1}{3}$ of the long rulers and $\frac{1}{6}$ of the short ones left. What was the total number of rulers left? (Singapore Examinations and Assessment Board 2014)

students often have difficulties drawing models to work through the solution process. They have difficulty constructing the before-after models and also determining the basic unit (Goh 2009). This certainly has implications for teacher education.

17.3.3 South Africa: Models of Situations

Hamsa Venkat

17.3.3.1 Organisation of Primary Teacher Education in South Africa

General or local organisation: There are national standards for teacher education, but these are at the generic, rather than subject-specific, level.

Teacher qualification: Primary teachers are usually trained as generalists, although some higher education institutions include optional ‘elective’ courses for training to be a mathematics specialist.

Curriculum for primary mathematics: There is a national curriculum for the primary mathematics years and, indeed, for all years of school mathematics. In recent iterations, mathematics curricula have seen an increase in the extent of specification of content and prescription of sequencing and pacing.

17.3.3.2 Recent Studies

The post-apartheid context in South Africa is one that is marked by a range of concerns: some focused within education and others focused on the broader socio-cultural terrain. Within education, there are ongoing concerns about mathematical performance and teachers' mathematical knowledge. In the broader society, praise for the extent of social mobility into the emerging and broadening 'middle class' has been tempered by alarm at the increasing extent of socio-economic inequality, which plays through into significant differences between the mathematical performance of students in elite schools and the rest of the population. In the early years of schooling, the predominance of unwieldy concrete counting-based methods has been widely reported (Schollar 2008; Ensor et al. 2009), with standardised curricula seeking increasingly to prescribe pacing and sequencing as one way of pushing progression to more sophisticated methods.

A recent study located in Intermediate Phase (Grades 4–6) pre-service teacher education has noted broad differences in the nature and extent of the mathematical content and pedagogic knowledge emphases within different courses, in spite of a broad national framework of standards for teacher education (Taylor 2011). In-service options for primary mathematics teaching development remain limited and piecemeal. In this context, the Wits Maths Connect-Primary project, a 5-year linked research and development project, established a 20-day in-service primary mathematics for teaching course. Responding to the need to encourage teachers to attend to structural relations between quantities rather than quantities solely as counted entities, the course focused particularly on key models of structural relations for additive and multiplicative situations. In other work, we have noted the ways in which teachers' representational and communicative repertoires have broadened through an approach in which recognition of the nature of relations between quantities and familiarity with key models that represent these relations can be used to simultaneously develop both mathematical and pedagogical competence (Venkat 2015; Venkat et al. 2016). Here, we note in relation to the WNA focus that we have discussed and used part-whole models similar to those promoted in the Singapore approach to represent a range of additive relations situations and used number lines as 'models for' calculating the relevant missing values. Similarly, double number lines, T-tables and area models have been discussed as models of a range of multiplicative situations. In relation to the earlier discussion of base ten (structural relation-oriented) and number line (ordinal) models, our use of both structural part-whole models and more operational number line models is directed at balancing the emphasis on counting and ordinal approaches that tend to be in the foreground of the early grades' curriculum (DBE 2011), by promoting attention to the relationships between quantities. This combination is purposively driven by evidence also of frequently algorithmic and error-prone 'columnwise' approaches seen in the Intermediate Phase years, showing limited carrying through of a quantified sense of number in increasing number ranges (Graven et al. 2013).

17.3.4 Thailand: Traditional vs Open Approach³

Maitree Inprasitha

17.3.4.1 Organisation of Primary Teacher Education in Thailand

General or local organisation: Following the Education Act in 1999, Thailand implemented national curricula for basic education in 2001 and national standards for teacher education in 2005. However, these standards focus primarily on knowledge with less emphasis on practical or professional competency.

Teacher qualification: Since 2004, K–12 teachers have been trained as specialists categorised into eight subjects such as mathematics and sciences, but there are also some optional programmes for those majoring in elementary education in a few institutions.

Curriculum for primary mathematics: There is a national curriculum for the primary mathematics years and for all years of school mathematics. These curricula focus on six domains: number and operation, measurement, geometry, algebra, data analysis and skills for mathematical processes.

17.3.4.2 Reforms in the New Century

While a new national agenda of ‘Reforming Learning Process’ of the 1999 Education Act was declared more than a decade ago, pre- and in-service mathematics teacher education programmes at most universities in Thailand have struggled to respond to this demand. Most teacher education programmes still emphasise subject matter (i.e. mathematics content at the university level in programmes for mathematics teachers) with little or no emphasis on courses associated with pedagogical content knowledge (Inprasitha 2015). This subject emphasis is viewed as exerting strong influence on the traditional teaching approach of school teachers, involving transmission of content-based approaches to the students.

Moreover, within these traditional teaching approaches, most Thai teachers heavily rely on using textbooks as key instructional media for classroom teaching practices. IEA results during the 1980s showed that more than 90% of Thai mathematics teachers used textbooks as a tool for teaching: they taught the content that appeared in the textbook and set student exercises from those textbooks. Currently, the exercises and the instruction guidelines in these textbooks still emphasise computation skills and techniques focused on rapid completion (Anderson et al. 1989). Mathematics teachers commonly use either the national textbook provided by the

³The study was supported by the Centre of Excellence in Mathematics, the Commission on Higher Education, Thailand; the Students’ Mathematical Higher Thinking Development Project in Northeastern Thailand; Centre for Research in Mathematics Education, Faculty of Education, Khon Kaen University.

Institute for the Promotion of Teaching Science and Technology (IPST) or private publishing company textbooks.

The traditional approach to teaching mathematics typically starts with teachers explaining new content through some examples related to rules or formula and then giving students a worksheet on some related examples and exercises (Kaewdang 2000; Khemmani 2005; Inprasitha 2011). As noted already, this teaching approach is teacher centred with the emphasis on teachers transmitting or transferring the contents to students (Inprasitha 2011).

Since 2004, the Faculty of Education at Khon Kaen University has run a new mathematics teacher education programme that has 57% of credits focused on PCK courses and 43% of credits for collegiate mathematics courses across the total 170 credits. The ‘open approach’, as a new mathematics teaching approach focused on teaching through problems, has been implemented both in the programme and also in the project schools collaborating with the Faculty of Education, Khon Kaen University, since 2006. This approach is described next.

17.3.4.3 An Exemplar of How Teachers Use the Approach

Teachers’ understandings of school mathematics from the textbook have influenced the way they teach mathematics in their classrooms. As Dossey (1992) has mentioned, comprehension for mathematical conceptual understanding is extremely important in development and success in mathematics teaching and learning in school and research understanding in school mathematics. An understanding of mathematical knowledge as ‘outside’ the teachers and students (Plato 1952 cited in Dossey 1992) can be linked to Thai mathematics teachers’ transmission orientation to knowledge to the students (Office of the Education Council 2013).

By contrast, in the Lesson Study project introduced by the Centre for Research in Mathematics Education (CRME) since 2006, the open approach (Inprasitha et al. 2003) has been introduced for developing rich mathematical activity based on open-ended problems (Nohda 1991; Inprasitha 1997). A group of student teachers did their practicum teaching in the 2002 academic year in seven secondary schools in Khon Kaen and found that these kinds of mathematical activities could change the way teachers interact with students and interacting among students themselves. Being engaged in the activity provides a chance for students to produce and generate various ways of thinking. This phenomenon was influential for teachers to become aware of their pedagogical beliefs about teaching mathematics (e.g. students cannot think by themselves unless the teachers provide the way for them to think first).

During 2003–2005, the open approach has been widely used by some 800 school teachers in Khon Kaen province through training by CRME. Between 2006 and 2009, four lesson study project schools implemented innovative mathematics teaching by incorporating three steps of lesson study into four steps of open approach (Fig. 17.5). In this project, the Japanese textbook of Gakko Toshō (Inprasitha and Isoda 2010, 2014) has been mainly used by the teachers in the project schools (Fig. 17.6).

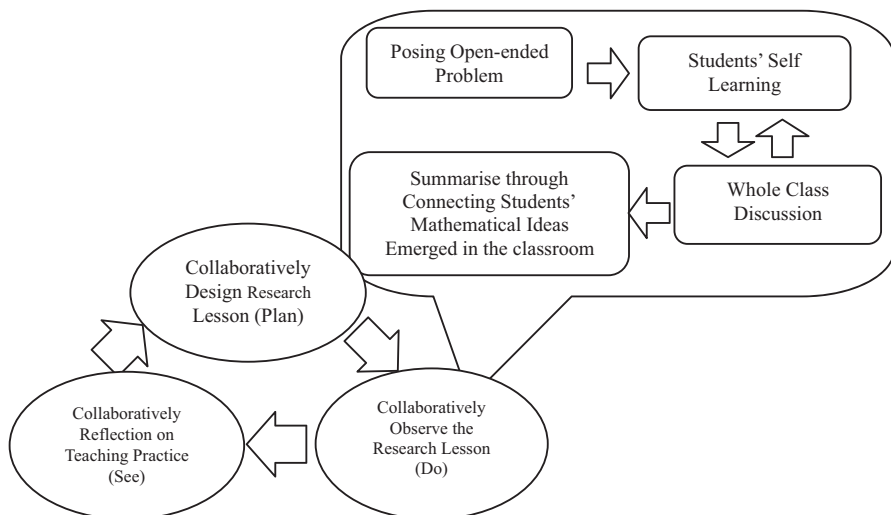

Fig. 17.5 Lesson study incorporating open approach (Inprasitha 2011)

17.3.4.4 An Exemplar of How Teachers Learn Through the Four Steps of Open Approach

Topic: Teaching $9 + 4$.

The objective of this learning unit (12 periods): The students can understand addition in terms of ‘together’ and ‘add up’ and use ‘base ten’ for addition.

Content in textbook – see Fig. 17.6.

Typically, in traditional teaching approaches, most Thai teachers teach $9 + 4$ using ‘count all’ or ‘count on’ techniques and focus on producing 13 as the answer to this situation. They tend to ignore the development of meaningful number sense through using students’ real-world experiences to teach addition. From previous classes, students know how to write $9 + 4$ as a number sentence for this situation. However, they might not know the meaning or number sense of $9 + 4$. Since this is the first time students will consider ‘addition in which the result is greater than 10’, then encouraging them to discover whether ‘ $9 + 4$ ’ is greater or less than 10 is as important as simply getting the answer of 13.

In the project schools use the tasks and steps shown in the textbook in Fig. 17.6. According to step ①, after interpreting the real-world situation as $9 + 4$, typically most school teachers focus on getting the answer, while in this textbook, the yellow cartoon provides a hint to the teacher to ask the question ‘Is the answer greater than 10?’ In order to answer this question, the students need to decompose 9 or 4 to making 10 according to step ②.

The textbook also provides models of students’ ideas to help beginner teachers anticipate students’ responses to the given questions as in Fig. 17.7.

Some beginner teachers raise questions about why we need to ask the question in step ① because they think students know earlier that 9 students together with 4 stu-



1 มีเด็ก 9 คน เล่นในกระบะทราย และมีเด็ก 4 คน กำลังเล่นกระดานเลื่อน มีเด็กทั้งหมดกี่คน



There are 9 children playing in a sandbox and 4 children playing on a slide. How many children are there altogether?

1 Write a number sentences

Is the answer greater than 10?



2 Let's think about how to find the answer.



What should we do to make 10?

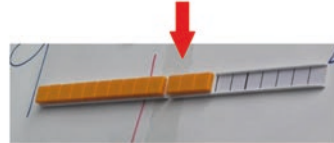

นักเรียนมีวิธีคิดอย่างไรได้บ้างเกี่ยวกับสถานการณ์นี้พอช่วย
 กลุ่ม 1 ป.1

$$\begin{array}{r} 9 + 4 = 13 \\ \underline{1} \\ 10 \\ \underline{3} \\ 13 \end{array}$$

เอาออก 1 จาก 9 เหลือ 8 แล้วเอา 2 จาก 4 มาบวกกับ 8 ได้ 10 แล้วเอา 3 จาก 4 มาบวกกับ 10 ได้ 13

9-4-13
 1-3
 10
 3
 13

ถ้าไปขอยืมจากเพื่อนจะได้เพิ่ม 10 ส่วน 4 จากเพื่อนจะได้ 3 รวมกับ 9 ได้ 13

9-4-13 10-4-13 10-4-13

$$\begin{array}{r} 9 + 4 = 13 \\ \underline{2} \\ 11 \\ \underline{2} \\ 13 \end{array}$$

เอาออก 2 จาก 9 เหลือ 7 แล้วเอา 3 จาก 4 มาบวกกับ 7 ได้ 10 แล้วเอา 3 จาก 4 มาบวกกับ 10 ได้ 13

9-4-13 9-4-13 9-4-13

3-6 3-6 3-6

10 10 10

13 13 13

ต่อม คู่ ขยับ เลข

Fig. 17.6 Contents and steps for teaching 9 + 4 (Extracted from Study with Your Friends: Mathematics for Elementary School 1st grade (in Thai))

Fig. 17.7 Students' responses for $9 + 4$
 (Extracted from Study with Your Friends: Mathematics for Elementary School 1st grade (in Thai))

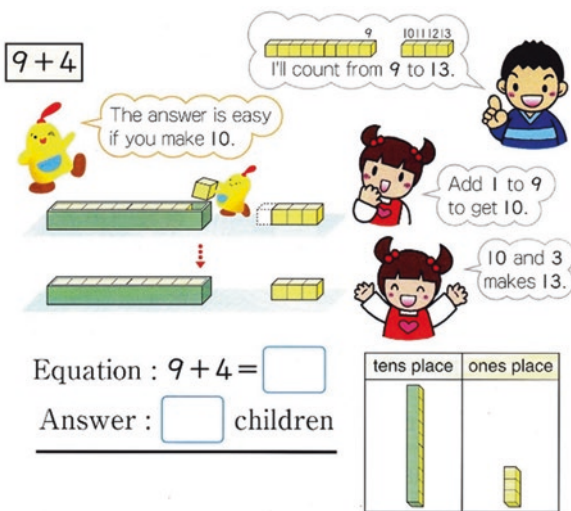

dents becomes 13 students. But this knowing is completely different from knowing ‘how to know’ what the $9 + 4$ number sentence means. Once students have obtained insight into making a 10, they can see that 4 can be decomposed into 1 and 3 and that this 1 can be associated with the 9 to make a 10. Students then notice they still have 3 left (using blocks or other materials). This discovery of ‘using decompose/compose and making ten strategy’ as a tool to do further addition is meaningful and has broader mathematical value.

Thus, for teachers, teaching using open approach helps them to extend their understanding of students’ ideas as useful for bridging the students’ real-world understandings into the mathematical world. For students, learning to solve given real-world situations by themselves accumulates their ‘how to learn’, which is more important for engaging in new problem situations.

17.3.5 Chinese Open-Class Approach⁴

Xu Hua Sun

17.3.5.1 Organisation of Primary Teacher Education in Macao

General or local organisation: Common teacher education standards are locally developed, but there is broad overlap in standards as all the teachers are mainly trained in University of Macau and a small part by Great China area.

⁴This study was supported by Research Committee, University of Macau, Macao, China (MYRG2015-00203-FED). The opinions expressed in the article are those of the author.

Teacher qualification: This depends on school tradition. Some schools inheriting the mainland tradition require specialists, but the schools inheriting the Portuguese or British tradition require generalists.

Curriculum for primary mathematics: There are common Macao curriculum standards developed by the Ministry of Education of Macao, but schools have the freedom to develop school-based curricula based on their educational visions and students' abilities.

17.3.5.2 Some Findings

The international literature base continues to both emphasise and discuss the mathematics content knowledge, pedagogical content knowledge and curriculum knowledge needed for effective primary mathematics teaching (Shulman 1986). The unity of these knowledge bases in action tends to receive less attention, appearing – particularly in Western traditions – to be largely assumed as automatically realised. The need for unification is the missing gap addressed by lesson study (or learning study or open class) in the East and is represented in Chinese and Japanese traditions as the main concern and question to be solved in the field of teacher education. Open class is a typical Chinese approach for teacher professional development which uses a single teaching circle, in which teachers are required to teach for 40 mins with half an hour for discussion; the open-class approach is more flexible than Japanese lesson study in terms of organisation, budgeting and timetabling (Sun et al. 2015). Learning study is a collaborative action research approach which aims to improve the effectiveness of student learning by enhancing the professional competence of teachers through joint construction of pedagogical content knowledge to help students to learn specific objects of learning based on variation theory, which originated in Hong Kong, and is now also a significant mode of practice in countries such as Sweden and Brunei (Cheng and Lo 2013). Lesson study is a Japanese model of teacher-led research in which a triad of teachers work together to target an identified area for development in their students' learning: using existing evidence, participants collaboratively research, plan, teach and observe a series of lessons, using ongoing discussion, reflection and expert input to track and refine their interventions. This section focuses on the open-class approach, a key strength of the Chinese system of teacher education. Key principles underlying the open-class approach in China are described below:

- For primary teacher education, a typical belief in Asia is that mathematics teachers should possess specific subject knowledge, which might be not known by lay people.
- Professional knowledge must be public and communicated among colleagues through collaboration.
- Professional knowledge must be storable and shareable.
- Professional knowledge requires a mechanism for verification and improvement.

This is one of the reasons why primary mathematics teachers in Mainland China are required, commonly, to be specialists, not generalists. A key antecedent for this belief may be Confucius' establishment of a tradition of deep respect for teachers in China – similar to lawyers and doctors in the West – but that is not common in the West with respect to teachers. However, this belief could also relate to an exam-driven teaching and learning culture, in which teacher professional knowledge, like student's knowledge, is expected to be examined through given lessons. The exam-driven culture in China can be linked to its great population and more limited resources. Similar to student examinations, there is a strict professional assessment system for practising teachers as part of career ladders in China. There are four formal hierarchical grades for teachers that indicate professional status in China, and promotion is based on school-based evaluation of the open class. In this way, teacher professional ranks (three ranks) are clearly defined. Compared with other systems, Chinese teachers' working time (about ten classes in each week) is low, but their research time is strictly stipulated/controlled. Open class is one of the windows to reflect their research results. This professional development tool is currently underrepresented in international research (lesson study is more well-known in the global context than open class; so far, open class is well-known within China only). It plays critical and different roles in teacher recruitment, professional assessment and professional research and development in primary teacher education to meet the goals of specialists (not generalists). How this tool has been transposed and applied in Macao and Italy are presented next.

17.3.5.3 The Goal of Open Class

The open-class approach was established in the early 1950s by the Chinese Ministry of Education with the primary purpose of organising teacher study groups in schools. There are two general categories of open classes, those for outside audiences and those for internal audiences. The classes for outside audiences are divided into three categories: open classes to publicly demonstrate new education ideas (e.g. new curriculum/textbook use and expert-level classroom instruction demonstrations), open classes for research (e.g. research lessons for new thought 觀摩課, 'same content-different-approach' 同課異構) and open classes for evaluation purposes (e.g. recruitment, teacher promotion and teaching competitions). These open classes generally involve a single teaching cycle of planning-designing-teaching-reflecting either by the conducting teachers or a school-based research group.

The open classes for internal audiences include single-circle open classes for mentor-mentee training (師徒公開課) and multiple-circle open classes for mentor-mentee training (校本培訓公開課). The multiple-circle open classes, which involve co-planning, co-designing, co-teaching and co-reflecting, are supported by school-based mentor-mentee programmes. This more complex open-class system is similar to the Japanese lesson study approach. Compared to those for outside audiences, the

internal training open classes are more effective for professional development, although they are also organisationally more demanding. These internal training open classes, which involve a series of different goals and are mainly organised by the teaching research group as a routine research activity, have played a role in securing incremental, accumulative and sustainable improvements in China (e.g. Huang et al. 2011). In these group classes, the teachers reflect on their teaching practice, design innovative activities based on class observations and engage in practitioner-driven research. These activities were originally aligned with the promotional criteria for teachers in Mainland China, where teachers are required to conduct research and publish practice-oriented papers in education journals or magazines and undergo regular teaching evaluations. This approach, which is also known as ‘learning study’ in Hong Kong (Sun 2007; Lo 2005) and ‘public class’ in China (Liang 2011; Shen et al. 2007), is a popular method for developing and enhancing the teaching profession in many countries. In practice, in an open class a group of teachers first observe a lesson taught by a colleague and then discuss its merits (Miyakawa and Winsløw 2013).

17.3.5.4 Open-Class Roles in Primary Teacher Professional Life

Open-class model:

- Has exploited the Chinese conception of teaching as a public activity with norms and structures that favour a *collaborative spirit*.
- Has exerted a major influence in the *professional development* of teachers in China for many years.
- Has played a major role in fostering *learning communities* within Chinese schools.
- Has proven to be an effective way to induct *new and inexperienced teachers* into the teaching profession.

This approach is simpler and more economical than the ‘lesson study’ method. When used in teacher education, the open-class approach enables pre-service teachers to observe more experienced teachers as part of their professional training. According to the literature, the open-class approach is used in many teacher preparation programmes to induct pre-service teachers into the practice of teaching (Wang and Paine 2003). The approach is also used for professional development and teacher evaluation in schools (Liang 2011).

In Mainland China, teachers are required to attend public classes (open classes) as part of the professional development activities in their school- or district-based research groups. This approach is largely shaped by Eastern traditions in which teaching is regarded as a public activity with norms and structures that favour collectivism (Liang 2011; Shen et al. 2007).

The open-class approach is an integral part of the educational audit culture in China. Accordingly, the open-class approach has been a major influence in the professional development of teachers in China for many years. Ecologically, the approach has also played a major role in fostering learning communities within Chinese schools. However, compared with Mainland China, the open-class approach is rarely employed in Macao.

17.3.5.5 The Difference: Open Class vs Lesson Study

These open classes generally require:

- Single cycles (planning-designing-teaching-reflecting) vs multiple cycles in lesson study.
- Involves within-school or research group teachers vs outside teacher/researcher in lesson study.
- More frequency daily practice vs non-daily practice in lesson study.
- Simpler/more economical vs complex procedure in daily practice.

17.3.5.6 Difficulties in transposing to Macao

A Portuguese colony for more than 400 years, Macao was returned to China in 1999. As part of the legacy of the decentralised governing style of the Portuguese era, 90% of the schools in present-day Macao are privately run and have their own diverse curricula. Given its colonial past, the culture of teaching in Macao schools has largely been shaped by Western traditions in which teaching is regarded as a private activity with norms and structures that favour individualism and autonomy (Li 2003). In addition, Macao's decentralised and fragmented education system does not have a common curriculum within and across grade levels.

Accordingly, there is no national framework to guide teachers and each school designs its own curriculum, assessment tasks and standards and grade progression criteria. Coupled with a heavy teaching load (more than 20 classes a week), it is almost impossible for teachers to engage in curricular improvement and participate in professional development. Consequently, there is little or no opportunity for experienced teachers to share their experience with beginning and new teachers. For example, in an interview, a teacher stated that without a class visit tradition, teachers regard their own classrooms as a private space and, therefore, tend to work alone: 'They are usually doing their own thing' (各忙各的).

Traditionally, pre-service teacher training in Macao is divided into 'theory' (subject matter, curriculum, educational theory and pedagogy) and 'practice'. The unity of theory and practice is considered unimportant, as it is supposed to be realised automatically in teaching practice. As a result, no pre-service teaching courses focus on the connections between theory and practice. None of the literature on teaching addresses the central questions on how the unity or integrity of theory and

practice is realised. Similarly, no research has examined whether particular theories are appropriate when they are applied in a classroom context (even though this question has become the central issue of teacher education). The lack of research on the role of unity within the teacher education curriculum can be regarded as a ‘missing paradigm’ (Day 1991, 1997; Cuban 1992).

Taking on board the idea that pedagogy is a culturally specific enterprise, we acknowledge that transposition requires adaptation. Here we present and discuss an instance of transposition of the open-class approach to Italy.

17.3.6 Open Class in Italy

Maria G. Bartolini Bussi

17.3.6.1 Organisation of Primary Teacher Education in Italy

General or local organisation: General organisation within governmental regulations. Some limited choices may be made locally.

Teacher qualification: Usually generalists. Some limited experiments of specialist mathematics teacher preparation are carried out in some primary schools.

Curriculum for primary mathematics: Common, with national standards.

17.3.6.2 Some Features of the Italian School System

The Italian mathematics curriculum is national (centralised) with weak control on processes: there is independent school management with governmental control (national assessment) at the end of the 2nd and 5th grades. Teachers are usually generalists (although some limited testing of specialist teachers is ongoing drawing on school independent management) (see the Table 17.1). Primary school teachers usually spend 5 years (the whole period of primary school) with the same group of students. The school system is totally inclusive, as all students (including students with special needs) are in mainstream classrooms.

17.3.6.3 Primary School Teacher Education and Development

A university master’s degree has been compulsory for primary school teachers since 1998. However, most current teachers in primary schools (especially the older ones) have only a secondary school degree, with, in general, little experience of in-service development activity (a law about compulsory in-service development activity was issued only in September 2015). Hence, in many schools, there are still teachers with limited preparation: relevant exceptions are represented by teachers who have been

Table 17.1 International comparison

	China	Macao	Italy
Language	Chinese (Mandarin/Cantonese)		Italian
Standard	National (centralised) standard strong control	Fragmented curriculum	National (centralised) standard weak control
Primary teachers' beliefs	Teaching as public activity	Teaching as private activity	
	Specialist	Generalist	

in touch with a university research group. This happened in Reggio Emilia, thanks to the efforts of the Department of Education and Human Studies and to a generally positive attitude towards education issues, realised by means of a programme of early childhood education that has gained international repute in the last quarter century (the so-called Reggio approach, <http://www.reggiochildren.it/?lang=en>).

17.3.6.4 Some Local Studies

In Italy (University of Modena and Reggio Emilia, Department of Education and Human Studies at Reggio Emilia) we started an experiment 4 years ago with some dozen schools, in order to implement a 'lesson study style' process. The principal investigator is Maria G. Bartolini Bussi, with the collaboration of Alessandro Ramploud and others (doctoral students, post-doc scholars from different universities, teachers, principals, educators coordinated by the branch of the Municipality of Reggio Emilia 'Officina Educativa', i.e. 'Educational Workshop').

17.3.6.5 The 'Open-Class Model' Programme

In this general situation, the principal investigator and collaborators launched a new programme for pre-service teacher education and in-service teacher development in 2012 that was inspired by the 'lesson study' model, as developed in Japan. The principal investigator had the opportunity to visit classrooms in Far East (Japan, China, Thailand). Hence, she came in contact with different implementations of similar (although not identical) models. The most important differences between the Italian schools and the Eastern schools may be summarised as follows:

- The presence of generalist vs specialist teachers.
- The permanence of the same teacher with the same group of students for many years vs for 1 year only.
- The attention to students with special needs in the mainstream classes (according to the totally inclusive model in Italy).
- The conception of the classroom as a private space vs. a public space where also critical observers are welcome.

The research group eventually chose the Chinese model of ‘open classes’, as it seemed more school centred than University centred. The intention, discussed also with teachers, educators and principals, was to disseminate a model that was under the responsibility of the education agencies of the zone, with no special role (except the starter one) for the University research group.

We chose the title (English acronym DOR):

to design – to observe – to redesign
a Mathematics lesson

in order to capture the meaning of the Chinese expression.

Guānmó kè 观摩课

Until now we have completed three summer schools and some dozen DOR pilot examples.

The three summer schools were held in September 2012, 2013, 2014 with primary school teachers and general educators (who support teachers with the organisation of classroom activities and afterschool workshops for students with special needs). A further public event was realised in December 2015, in order to disseminate the last outcomes, with a further event held in November 2016.

At the beginning (2012 and 2013), the summer schools aimed at introducing participants to some activities typical of other cultures, mainly from the Far East, in order to foster discussion about cultural factors that are beyond the choices that are considered ‘universal’. We were inspired by Jullien’s statement:

This is not about comparative philosophy, about paralleling different conceptions, but about a philosophical dialogue in which every thought, when coming towards the other, questions itself about its own unthought. (Jullien 2006, p. iii)

The approach was very successful: from the first to the second summer school, we had an increase of participants from about 80 to more than 200.

We then started a cooperation with some selected schools, discussing with principals the possibility of realising in their schools pilot examples of DOR for mathematics lessons with a structure that may be roughly summarised as follows:

- 3 hours: design (for a group of teachers, educators and student teachers).
- 1 hour: lesson (with observers, including educators in charge of video documentation of the lesson).
- 3 hours: analysis and redesign (for a group of teachers, educators and student teachers).

The trickiest issue from the beginning was to force teachers to focus on the limited time of a lesson (about 45/60 mins). Italian teachers are not accustomed to controlled, careful, short-term processes, tending instead to work as long as needed on a particular issue, without focusing on the time span of a single lesson. With these experiments we wished to introduce attention to the careful design of short-term processes.

Table 17.2 Summary of experiments

Number of DOR experiments	Number of schools involved	Number of teachers	Number of educators
67	41	205	8

Long-term processes, in our approach, are designed and controlled by the semiotic mediation framework (Bartolini Bussi and Mariotti 2008).

The first pilot examples were publicly presented and discussed in the 3rd summer school (September 2014) with the invitation of more teachers.

Proceedings and documentation of all the three summer schools have been published in Italian and partially discussed in the doctoral thesis of Alessandro Ramploud (2015). More experiments are currently ongoing (Table 17.2). A research study concerning one of the teaching experiments has been published (Bartolini Bussi et al. 2017).

Also, some student teachers are involved in the experiments, as part of their practicum (internship) and, in some cases, as part of their master's dissertations, and some new teachers are involved.

The strength of the programme may be summarised as follows:

- Links with international programmes, with attention to the cultural aspects.
- Participation of principals in the definition of aims and goals.
- Extensive spread over the province and beyond.
- Mixed experience group (expert teachers, new teachers, students teachers, educators).

17.3.7 Czech Republic: Critical Places in School Mathematics

Jarmila Novotná

17.3.7.1 Organisation of Primary Teacher Education in the Czech Republic

General or local organisation: Locally developed, each faculty providing teacher education has individual curricula accredited by the Ministry of Education, Youth and Sports.

Teacher qualification: Generalists, possibility to extend the qualification by one subject.

Curriculum for primary mathematics: A general national framework education programme, individual school education programmes.

17.3.7.2 Critical Places: The Case of Word Problems

Future teachers' ideas about school mathematics and its teaching strategies are significantly influenced by their previous experiences from their home, school and society (see, e.g. Pasch et al. 1995). Their previous experience can have a considerable impact on their ability to get insight into the cognitive processes of pupils, who meet new, and for them, often surprising concepts, properties and relations or obstacles. As noted by Even and Ball (2009):

future elementary teachers in general use only weak mathematical conceptions, which often do not help them to realise their educational ambitions. On a general educational level, many of these students advocate discovery learning and collective problem solving, but when it comes down to the mathematical activities that have to be prepared, their experience of 'traditional' school mathematics is of little help. [...] For both future teachers, elementary as well as secondary, building conceptions of mathematically rich and cognitively and socially stimulating school mathematical activities is at the heart of the process of their professional formation. (p. 35)

Teacher education in the Czech Republic is based on the idea that changes in mathematical education are substantially dependent on changes in teacher education. These changes must take into account the needs of practice. Resources from practice are collected in different ways, from official educational documents for schools through data collection organised by educational management to research organised at universities and research institutions such as the Czech Academy of Science. In this text we present information gathered from the research project *Kritická místa matematiky základní školy, analýza didaktických praktik učitelů* (*Critical places of basic school mathematics, analysis of teachers' didactical practices*). The project ran from 2011 to 2014 in the Czech Republic, and its results are being transferred into teacher education. The aim of the project was to discover which issues in compulsory school mathematics cause the main obstacles for further learning of Czech pupils.

In this text, we will restrict our focus to the primary school (the first 5 years of compulsory school attendance). The results from the project were published among others in two monographs: Rendl et al. (2013) and Vondrová (2015). While in Rendl et al. (2013), teachers' views and experiences are collected and analysed, in Vondrová (2015) these results are further elaborated and verified with pupils.

For data collection, in-depth interviews with individual respondents were used. The interviewer posed open questions and had the opportunity to add further specific questions in case of necessity.

The aim of the research with teachers (Rendl et al. 2013) was to find out which domains of school mathematics teachers evaluated as critical, how they dealt with them and what they saw as the reasons for pupils' difficulties. Textbooks that respondents used in his/her teaching were used as supporting material. From the domains related to WNA teachers evaluated rounding and estimating, arithmetical operations and word problems as the most difficult for primary pupils (Jirotková and Kloboučková 2013). The in-depth interviews were followed up with a questionnaire-based survey aimed at enriching some of the information gained in

the interviews. In the research with pupils, during the in-depth interviews, pupils solved selected problems and described their mental processes (Vondrová 2015).

We present here only the results dealing with word problems as a part of the results linked directly with WNA (for more detailed information, see Havlíčková et al. 2015). The research showed that in the domain of word problems at the primary level, the most difficult aspects for pupils were:

- Understanding of text and grasping the problem.
- Recording the problem structure, pictures, schemes and models.
- Words in the function of an ‘antesignal’, i.e. that cues an operation different to the one required.
- States and their transformation in problems of comparison.
- Sets and their parts.
- Mathematical ‘craft’ – numerical errors and errors in algorithms.
- ‘Chaining’ numerical operations and pieces of information in the assignment.
- Fractions in a word problem.
- Conversion of units.

According to teachers, reading comprehension was a key issue. They pointed out pupils’ inability to choose essential pieces of information in a text, to formulate the answer to the question in the assignment and several other problems they had encountered during their teaching practice.

In the questionnaire survey (Havlíčková et al. 2015), it was found that the textbook was the most important support for teachers in their teaching although they sometimes also used additional materials (other textbooks, collections of problems, own materials, etc.). The survey also provided other information directly linked with word problems in primary mathematics, concerning issues that teachers consider as important for their successful solving. For example, most participating teachers put emphasis on the need to automate pupils’ calculations. For successful problem solving of a word problem, they considered working with ‘problem types’ and creating records of their differing structures to be very important. Nearly all teachers guided their pupils to choose words in the assignment that signalled the arithmetical operation. They believed that success in solving word problems was associated with pupils with higher cognitive dispositions, with weaker pupils facing difficulties when solving word problems. When discussing differences between successful and less successful solvers of word problems, teachers mostly mentioned differences in transforming a word problem text into a mathematical structure (i.e. with mathematisation) and differences in the ability to work systematically and to firstly determine a suitable solving procedure. Small differences were reported in the speed of performing arithmetical operations.

Although the findings from the survey do not speak directly about teacher education, they do provide useful pointers. Teachers need to be well prepared to work in an environment of diversity of pupils in all aspects. Preparing them for working for inclusion is one of the important tasks for teacher education, with teacher responses to word problems as demarcating between strong and weak students providing evidence of current beliefs standing against this view (Brousseau and Novotná 2008).

It is broadly accepted that during their pre-service, as well as in-service, education teachers' attention should be directed to structural relations; focus on keywords and operations is not sufficient (Hejný 2012).

In order to help their pupils to develop their knowledge of mathematics as well as positive attitudes towards mathematics, teachers will need a good command of mathematical and pedagogical knowledge. When entering the practice after graduating as primary teachers, they will not only work with their pupils but will also, importantly, cooperate and learn from (experienced) colleagues. Teacher education should prepare future teachers for all aspects of their teacher professional life; knowing the subject is not the only necessity. The results from the project are important for primary mathematics teacher education. Future teachers must undergo a suitable education for opening for them the possibility of helping their pupils to overcome critical obstacles. Lastly, teachers' approaches to overcoming their pupils' difficulties when learning mathematics are influenced not only by their mathematical and pedagogical content knowledge (which is a common part of all primary teacher education), but also by their personal characteristics.

17.4 Discussion

Mike Askew

In the presentations given at the conference, several common themes emerged that included, first, the recognition of the need for teaching WNA to have increased emphasis on problem solving (as opposed to simply focusing on teaching arithmetical fluency) and, second, the importance of the working with concrete and pictorial representations. Interested readers are likely not to be surprised to learn of these themes. Such issues have been on the mathematics education agenda for many years. Yet the evidence, both within the conference (see, e.g., the contribution by Mulligan and Woolcott 2015) and in the mathematics education literature, more generally (see, e.g., Cai 2003) suggests that we, the teacher education community, have had mixed success in achieving such changes.

For example, with regard to the role of representations, a discussion that emerged during a panel session at the conference illustrates how work still needs to be done on the balance and relationship between using ordinal (number line) and cardinal (base ten blocks) models as representation for WNA. A number of European participants argued strongly for the number line as a core model for WNA, but the more local speakers, while not dismissing using the number line altogether, clearly were less enamoured of it, being keener on cardinal images of number. Why might there be differences of opinion on this?

One argument put forward emphasising the use of number lines is that they provide learners with reinforcement of core whole number fluencies, such as making numbers up to the next multiple of ten or partitioning single digits. For instance, in adding 9 onto 24 on an empty number line, making a jump of 6 from 24 to 30 rein-

forces making 24 up to the next multiple of ten and simultaneously reinforces the bond of $9 = 6 + 3$. There is also the argument that working with the number line encourages strategic thinking, through it being amenable to different approaches. Taking $25 + 9$, jumping 10 on the number line to 35 can encourage thinking in terms of a compensation strategy by then subtracting 1 from 35.

Yet observing a demonstration lesson in Macao (see Chap. 11, this volume), the approach taken in the lesson was based on a cardinal model of $24 + 9$ and yet still reinforced similar fluencies. In one method put forward by the learners, 9 was partitioned into 6 and 3 in anticipation of making 24 up to 30. And again, strategic thinking was encouraged – the learners produced at least three different solution methods. In contrast to the methods that emerge using the number line, all these methods were based on partitioning – in addition to partitioning 9 into 6 + 3, 24 was partitioned into $23 + 1$ to create $23 + (1 + 9)$ or into $20 + 4$ to create $20 + (4 + 9)$. This latter method, although recorded horizontally in this lesson, lends itself to being linked to the standard vertical algorithm, so it may be that the preference for a cardinal model is rooted in an eye to the mathematical horizon.

Thus, it could be argued that the Western preference of the number line model is based on a preference for encouraging flexible efficiency, developing and using methods that are related to the numbers in the calculation, thus using compensation to add, say, 9 or 19. This flexibility is often linked back to individual differences that the number line explicitly promotes as a model that allows for emergent approaches at a range of levels of sophistication. In contrast, while multiple methods are encouraged within cardinal models, there is much more reference in this work to strategies that relate to the underlying mathematical structure of the task situation than to individual differences.

The conference presentations thus point to the need for further research into how the two models of whole number – ordinal (number line) and cardinal (base ten blocks) – complement each other, rather than teacher educators across the globe ‘agreeing to disagree’ on which is the more favourable representation. But these bodies of research also suggest that it may be necessary to look ‘through’ such research to the basic aims and philosophy of education that guide the choice and use of models. And, importantly, could the mathematics teacher education community then come to some agreement on how best to work with pre-service teachers on both models, rather than privileging one over the other, or, as seems to be the case in many teacher education programmes, leaving it up to prospective teachers to choose for themselves which model they prefer to work with.

Such distinctions go to the heart of different perspectives of what it means to be a professional. For example, in many teacher education programmes in English-speaking nations, the approach is to introduce pre-service teachers to a range of pedagogical approaches and representations in the expectation that they, as professionals, can decide for themselves which they think may be most effective. In contrast, in places like Singapore and Shanghai, it is clear that there is more consensus on which approaches to use. In part, such consensus may be the result of structural and historical circumstances. Being a small nation, Singapore has only one teacher education institution and a small community of educators working with both pre-

and in-service teachers. China has a long history of careful curriculum development and long-standing use of textbooks linked to the curriculum.

At the time of writing, there are initiatives in England to encourage teachers to adopt pedagogies based on those from Singapore and Shanghai, together with more use of textbooks. While teachers are welcoming these initiatives, there is less enthusiasm in some parts of the mathematics education community. Objections range from the argument that these initiatives are downplaying the good practices that already exist in England through to arguing that ‘training’ teachers to teach in particular ways is a threat to their professionalism.

Thus it would seem that difficulties in promoting, say, more problem solving and better use of representations may lie as much in the beliefs and practices of the mathematics education community as it does in the school and teaching community. While there is no shortage of research into teacher change, or the lack of it, are we, as mathematics educators and researchers, sufficiently self-reflective on whether or not our beliefs and practices need to change? Much of the research into teacher education addresses the question ‘What do teachers need to do differently?’, but do we pay sufficient attention to the parallel question ‘What could we (the teacher educators) do differently?’ We might begin to address this question by looking at some of our beliefs and, in particular, at our theory of knowledge.

Since Shulman’s seminal work on the distinction between content knowledge and pedagogic content knowledge, there has been a plethora of studies into knowledge for teaching, most of which theorise different models and try to tease apart exactly what the difference between content knowledge and pedagogic content knowledge might look like. In many higher education institutions, there is contestation over where the mathematics for teaching should be taught – should it be taught in education departments or in faculties of mathematics? And we know from research that the relationship between studying higher mathematics in contexts divorced from addressing issues of pedagogy is only weakly associated with later success as a teacher (see, e.g., Wilson et al. 2001) (which, of course, is not to say that knowledge of mathematics is not important, but that it is a particular sort of mathematical knowledge that matters). So there is a political dimension to the research in knowledge for teaching, but has that research now established a sound body of findings as to exactly what mathematics pre- and in-service teachers need to be taught? Does the culture of research in teacher education encourage the cumulative building of knowledge into effective teacher education, with each other’s work being built on and developed? Or is our culture one of individual reputations needing to be established? As Michael Billig argues, much writing in social sciences generally now has overtones of the culture of advertising, with different theories ‘positioning themselves’ in the field rather than complementing each other (Billig 2013).

Thus, a theory of knowledge that underpins much of the research in places like the USA and UK has at its heart the development of the individual (teacher and researcher). Knowledge is in the mind of the individual; it is the personal, individual knowledge and skills of the teacher that needs to be ‘developed’. Other traditions of development, for example lesson study in Japan (Lewis 2002), focus more, how-

ever, on teaching than on teachers. And, as the papers in Topic Group 4 suggest, within such cultures there may be less of a tradition of teachers choosing pedagogic approaches for themselves – the ‘technology’ of teaching is more in the hands of textbook and curriculum developers. The knowledge is not only in the heads of teachers, but also in the resources made available to them.

References

- Alexander, R. J. (2009). Towards a comparative pedagogy. In R. Cowen & A. M. Kazamias (Eds.), *International handbook of comparative education* (pp. 923–942). Dordrecht: Springer.
- Anderson, L. W., Ryan, D. W., & Shapiro, B. J. (1989). *The IEA classroom environment study*. Oxford: Pergamon Press.
- Anghileri, J. (2006). *Teaching number sense*. London: Continuum Press.
- Bartolini Bussi, M. G., & Mariotti, M. A. (2008). Semiotic mediation in the mathematics classroom: Artefacts and signs after a Vygotskian perspective. In L. English, M. Bartolini, G. Jones, R. Lesh, B. Sriraman, & D. Tiros (Eds.), *Handbook of international research in mathematics education* (2nd ed., pp. 746–783). New York: Routledge Taylor & Francis Group.
- Bartolini Bussi, M. G., & Martignone, F. (2013). Cultural issues in the communication of research on mathematics education. *For the Learning of Mathematics*, 33(1), 2–8.
- Bartolini Bussi, M. G., & Baccaglioni-Frank, A. (2015). Geometry in early years: Sowing seeds for a mathematical definition of squares and rectangles. *ZDM Mathematics Education*, 47(3), 391–405.
- Bartolini-Bussi, M. G., Bertolini, C., Rampous, A., & Sun, X. (2017). Cultural transposition of Chinese lesson study to Italy: An exploratory study on fractions in a fourth-grade classroom. *International Journal for Lesson and Learning Studies*, 6(4), 380–395.
- Beckmann, S., & Izsák, A. (2015). Two perspectives on proportional relationships: Extending complementary origins of multiplication in terms of quantities. *Journal for Research in Mathematics Education*, 46(1), 17–38.
- Beishuizen, M. (1993). Mental strategies and materials or models for addition and subtraction up to 100 in Dutch second grades. *Journal for Research in Mathematics Education*, 24(4), 294–323.
- Billig, M. (2013). *Learn to write badly: How to succeed in the social sciences*. Cambridge: Cambridge University Press.
- Brousseau, G., & Novotná, J. (2008). La culture scolaire des problèmes de mathématiques. In Sarrazy, B. (Ed.), *Les didactiques et leurs rapports à l'enseignement et à la formation. Quel statut épistémologique de leurs modèles et de leurs résultats ?* Bordeaux : AFIRSE, IUFM d'Aquitaine – Université Montesquieu Bordeaux IV, LACES – Université Victor Segalen Bordeaux 2. [CD ROM].
- Cai, J. (2003). What research tells us about teaching mathematics through problem solving. In F. Lester (Ed.), *Research and issues in teaching mathematics through problem solving* (pp. 241–254). Reston: National Council of Teachers of Mathematics.
- Chan, C. M. E., & Cole, D. (2013a). *Targeting mathematics 2B*. Singapore: Star Publishing Pte Ltd.
- Chan, C. M. E., & Cole, D. (2013b). *Targeting mathematics 1A*. Singapore: Star Publishing Pte Ltd.
- Chan, C. M. E., & Cole, D. (2013c). *Targeting mathematics 2A*. Singapore: Star Publishing Pte Ltd.
- Cheng, E. C. K., & Lo, M. L. (2013). *The approach of learning study: Its origin and implications*. OECD CERI Innovative Learning Environments project. Retrieved from: <http://www.oecd.org/edu/ceri/Eric%20Cheng.Learning%20Study.pdf>.

- Common Core State Standards Initiative. (2010). *The common core state standards for mathematics*. Washington, DC: Author.
- Conference Board of the Mathematical Sciences. (2012). *The mathematical education of teachers II*. Washington, DC: Author.
- Cuban, L. (1992). Managing dilemmas while building professional communities. *Educational Researcher*, 21(1), 4–11.
- Day, C. (1991). Roles and relationships in qualitative research on teachers' thinking: A reconsideration. *Teaching and Teacher Education*, 7(5–6), 537–547.
- Day, C. (1997). Being a professional in schools and universities: Limits, purposes and possibilities for development. *British Educational Research Journal*, 23(2), 193–208.
- Department for Basic Education (DBE). (2011). *Curriculum and Assessment Policy Statement (CAPS): Foundation phase mathematics, grade R-3*. Pretoria: Department for Basic Education.
- Dossey, J. A. (1992). The nature of mathematics: Its role and its influence. In D. A. Grouws (Ed.), *Handbook of research on mathematics teaching and learning* (pp. 39–48). New York: MacMillan.
- Edwards, B. S., & Ward, M. B. (2004). Surprises from mathematics education research: Student (mis)use of mathematical definitions. *The American Mathematical Monthly*, 111(5), 411–424.
- Ensor, P., Hoadley, U., Jacklin, H., Kühne, C., Schmitt, E., Lombard, A., & van den Heuvel-Panhuizen, M. (2009). Specialising pedagogic text and time in foundation phase numeracy classrooms. *Journal of Education*, 47, 5–30.
- Even, R., & Ball, D. L. (Eds.). (2009). *The professional education and development of teachers of mathematics. The 15th ICMI study*. New York: Springer.
- Goh, S. P. (2009). *Primary 5 pupils difficulties in using the model method for solving complex word problems*. MEd dissertation, National Institute of Education, Nanyang Technological University.
- Graven, M., Venkat, H., Westaway, L., & Tshesane, H. (2013). Place value without number sense: Exploring the need for mental mathematical skills assessment within the annual national assessments. *South African Journal of Childhood Education*, 3(2), 131–143.
- Havlíčková, R., Hříbková, L., & Páchová, A. (2015). Slovní úlohy jako kritické místo matematiky I. stupně základní školy. In M. Rendl & N. Vondrová (Eds.), *Kritická místa matematiky na základní škole očima učitelů* (pp. 18–101). Praha: Univerzita Karlova v Praze.
- Hejny, M. (2012). Exploring the cognitive dimension of teaching mathematics through scheme-oriented approach to education. *Orbis Scholae*, 2(6), 41–55.
- Huang, R., Li, Y., Zhang, J., & Li, X. (2011). Improving teachers' expertise in mathematics instruction through exemplary lesson development. *ZDM*, 43(6/7), 805–817.
- Inprasitha, M. (1997). Problem solving: A basis to reform mathematics instruction. *Journal of the National Research Council of Thailand*, 29(2), 221–259.
- Inprasitha, M., Narot, P., Pattanajak, A., Prasertcharoensuk, T., & Trisirirat, J. (2003). *Reforming of the learning processes in school mathematics with emphasizing on mathematical processes*. Research report submitted to the National Research Council of Thailand. Khon Kaen: Khon Kaen Karnphim (In Thai).
- Inprasitha, M., & Isoda, M. (2010). *Study with your friends: Mathematics for elementary school 1st grade*. Khon Kaen: Klungnanawittaya. (In Thai).
- Inprasitha, M. (2011). One feature of adaptive lesson study in Thailand: Designing a learning unit. *Journal of Science and Mathematics Education in Southeast Asia*, 34(1), 47–66.
- Inprasitha, M., & Isoda, M. (2014). *1st grade mathematics textbook glossary*. Khon Kaen: Khon Kaen University Publications.
- Inprasitha, M. (2015, May). New model of teacher education program in mathematics education: Thailand experience. In C. Vistro-Yu (Ed.), *Proceedings of the 7th ICMI-East Asia Regional Conference on Mathematics Education*, vol. 1, pp. 97–104.
- Jirotková, D., & Kloboučková, J. (2013). Kritická místa matematiky na I. stupni základní školy v diskurzu učitelů. In M. Rendl & N. Vondrová (Eds.), *Kritická místa matematiky na základní škole očima učitelů* (pp. 19–61). Praha: Univerzita Karlova v Praze, Pedagogická fakulta.
- Jullien, F. (2006). *Si parler va sans dire. Du logos et d'autres ressources*. Paris: Editions du Seuil.
- Kaewdang, R. (2000). *Thai educational evolution*. Bangkok: Matichon Publishers. (in Thai).

- Khemmani, T. (2005). *Sciences of teaching: Knowledge for efficiency teaching and learning*. Bangkok: Chulalongkorn University.
- Kho, T. H. (1987). Mathematical models for solving arithmetic problems. *Proceedings of the 4th Southeast Asian Conference on Mathematics Education (ICMI-SEAMS)* (pp. 345–351). Singapore.
- Lewis, C. (2002). Does lesson study have a future in the United States? *Nagoya Journal of Education and Human Development*, 1(1), 1–23.
- Li, S. P. T. (2003). The changing face of junior secondary teacher education in Macao. In R. D. Y. Koo, S. W. Wu, & S. P. T. Li (Eds.), *Education development and curriculum innovations: Perspectives and experience from Mainland China, Taiwan, Hong Kong and Macao* (pp. 51–75). Hong Kong/Macao: The Association for Children's Education International.
- Liang, S. (2011). *Open class – An important component of teachers' in-service training in China*. http://www.math.csusb.edu/faculty/sliang/J.EDU_openclass
- Lo, M. L. (2005). *Changing the educational scene in Hong Kong through learning study*. Symposium presentation at international conference on education 'Redesigning pedagogy: Research, policy, practice', Singapore, May 30–June 1.
- Ma, L. (1999). *Knowing and teaching elementary mathematics: Teachers' understanding of fundamental mathematics in China and the United States*. Mahwah: Lawrence Erlbaum Associates.
- Ministry of Education. (2009). *The Singapore model method for learning mathematics*. Singapore: Author.
- Miyakawa, T., & Winsløw, C. (2013). Developing mathematics teacher knowledge: The paradigmatic infrastructure of "open lesson" in Japan. *Journal of Mathematics Teacher Education*, 16(3), 185–209.
- Ng, S. F., & Lee, K. (2009). The model method: Singapore children's tool for representing and solving algebraic word problems. *Journal for Research in Mathematics Education*, 40(3), 282–313.
- Nohda, N. (1991). *A study of open-approach strategy in school mathematics teaching* (in Japanese). Office of the Education Council, Ministry of Education of Thailand. (2013). *Analysis of a status of teachers' development and suggestions for teachers' development to students' development*. Bangkok: Prigwhan graphics. (In Thai.)
- Pasch, M., et al. (1995). *Teaching as decision making*. Addison-Wesley: Longman.
- Plato. (1952). *The dialogues of plato*. Chicago: William Benton.
- Ramploud, A. (2015). 数学 [shùxué] matematica, sguardi (d)alla Cina [...] ogni pensiero, nel farsi incontro all'altro si interroga sul proprio impensato (English translation: 数学 [shùxué] Mathematics, take a look to-and-fro China [...] every thought, when coming towards the other, questions itself about its own unthought. University of Modena and Reggio Emilia: MoReThesis., <https://morethesis.unimore.it/theses/available/etd-03112015-100720/>
- Rendl, M., Vondrová, N. et al. (2013). *Kritická místa matematiky na základní škole očima učitelů*. Praha: Univerzita Karlova v Praze, Pedagogická fakulta.
- Schmittau, J. (2003). Cultural historical theory and mathematics education. In A. Kozulin, B. Gindis, V. S. Ageyev, & S. M. Miller (Eds.), *Vygotsky's educational theory in cultural context* (pp. 225–245). Cambridge: Cambridge University Press.
- Schollar, E. (2008). *Final report: The primary mathematics research project 2004–2007. Towards evidence-based educational development in South Africa*. Johannesburg: Eric Schollar & Associates.
- Shen, J., Zhen, J., & Poppink, S. (2007). Open lessons: A practice to develop a learning community for teachers. *Educational Horizons*, 85(3), 181–191.
- Shulman, L. (1986). Those who understand: Knowledge growth in teaching. *Educational Researcher*, 15(2), 4–14.
- Singapore Examinations and Assessment Board. (2014). *2012–2014 Primary School Leaving Examination (PSLE) mathematics questions*. Singapore: Educational Publishing House Pte Ltd.
- Sun, X. (2007). *Learning study: Multiple chances for teacher learning*. Paper presented at the World Association of Lesson Studies international conference 2007. Abstract Code: 079. <http://www.worldals.org/>.

- Sun, X. H., Neto, T. B., & Ordóñez, L. E. (2013). Different features of task design associated with goals and pedagogies in Chinese and Portuguese textbooks: The case of addition and subtraction. In C. Margolinas (Ed.), *Task design in mathematics education. Proceedings of ICMI Study 22* (pp. 409–418). Oxford, United Kingdom. Retrieved February 10, from <https://hal.archives-ouvertes.fr/hal-00834054v3>
- Sun, X., Teo, T., & Cheung Chan, T. (2015). Application of the open-class approach to pre-service teacher training in Macao: A qualitative assessment. *Research Papers in Education*, 30(5), 567–584.
- Tall, D., & Vinner, S. (1981). Concept image and concept definition in mathematics with particular reference to limits and continuity. *Educational Studies in Mathematics*, 12(2), 151–169.
- Taylor, N. (2011). *The National School Effectiveness Study (NSES): Summary for the synthesis report*. Johannesburg: JET Education Services.
- Tempier, F. (2013). *La numération décimale de position à l'école primaire: une ingénierie didactique pour le développement d'une ressource*. Thèse, Université Paris 7.
- Triandis, H. C., & Trafimow, D. (2001). Cross-national prevalence of collectivism. In C. Sedikides & M. B. Brewer (Eds.), *Individual self, relational self, and collective self* (pp. 259–276). Philadelphia: Psychology Press/Taylor & Francis.
- Tsamir, P., Tirosh, D., Levenson, E., Barkai, R., & Tabach, M. (2015). Early-years teachers' concept images and concept definitions: Triangles, circles, and cylinders. *ZDM Mathematics Education*, 47(3), 497–509.
- Venkat, H., Askew, M., Abdulhamid, L., Morrison, S., & Ramatlapana, K. (2016). *A mediational approach to expanding in-service primary teachers' mathematical discourse in instruction*. ICME 13 (Hamburg) Invited plenary paper, TSG 49.
- Vergnaud, G. (1988). Multiplicative structures. In J. Hiebert & M. Behr (Eds.), *Number concepts and operations in the middle grades* (pp. 141–161). Reston/Hillsdale: National Council of Teachers of Mathematics/ Lawrence Erlbaum.
- Vinner, S. (1991). The role of definitions in the teaching and learning of mathematics. In D. O. Tall (Ed.), *Advanced mathematical thinking* (pp. 65–81). Dordrecht: Kluwer Academic Publishers.
- Vondrová, N., & Rendl, M. a kol. (2015). *Kritická místa matematiky základní školy v řešeních žáků*. Praha: Univerzita Karlova v Praze.
- Wang, J., & Paine, L. (2003). Learning to teach with mandated curriculum and public examination of teaching as contexts. *Teaching and Teacher Education*, 19(1), 75–94.
- Wilson, S. M., Floden, R. E., & Ferrini-Mundy, J. (2001). *Teacher preparation research: Current knowledge, gaps, and recommendations. An executive summary of the research report*. Washington, WA: University of Washington, Center for the Study of Teaching and Policy. Document Number.
- Zaslavsky, O., & Shir, K. (2005). Students' conceptions of a mathematical definition. *Journal for Research in Mathematics Education*, 36(4), 317–346.
- Zazkis, R., & Leikin, R. (2008). Exemplifying definitions: A case of a square. *Educational Studies in Mathematics*, 69(2), 131–148.

Cited papers from Sun, X., Kaur, B., & Novotna, J. (Eds.). (2015). Conference proceedings of the ICMI study 23: Primary mathematics study on whole numbers. Retrieved February 10, 2016, from www.umac.mo/fed/ICMI23/doc/Proceedings_ICMI_STUDY_23_final.pdf

- Askew, M. (2015). Seeing through place value: An example of connectionist teaching (pp. 399–406).

- Beckmann, S., Izsák, A., & Ölmez, I. B. (2015). From multiplication to proportional relationships (pp. 518–525).
- Chambris, C. (2015). Mathematical foundations for place value throughout one century of teaching in France (pp. 52–59).
- Kaur, B. (2015). The model method: A tool for representing and visualizing relationships (pp. 448–455).
- Mulligan, J., & Woolcott, G. (2015). What lies beneath conceptual connectivity underlying whole number arithmetic (pp. 220–228).
- Novotná, J. (2015). Panel on teacher education (pp. 613–618).
- Venenciano, L., Slovin, H., & Zenigami, F. (2015). Learning place value through a measurement context (pp. 575–582).
- Venkat, H. (2015). Representational approaches to primary teacher development in South Africa (pp. 583–588).

Open Access This chapter is licensed under the terms of the Creative Commons Attribution 4.0 International License (<http://creativecommons.org/licenses/by/4.0/>), which permits use, sharing, adaptation, distribution and reproduction in any medium or format, as long as you give appropriate credit to the original author(s) and the source, provide a link to the Creative Commons license and indicate if changes were made.

The images or other third party material in this chapter are included in the chapter's Creative Commons license, unless indicated otherwise in a credit line to the material. If material is not included in the chapter's Creative Commons license and your intended use is not permitted by statutory regulation or exceeds the permitted use, you will need to obtain permission directly from the copyright holder.



Part IV
Plenary Presentations

Chapter 18

The Theory of School Arithmetic: Whole Numbers



Liping Ma  and Cathy Kessel 

18.1 Introduction

There are at least two different perspectives on whole number arithmetic in primary school. In the USA, the tendency is to consider it as only learning to compute the four basic operations with whole numbers (e.g. asking students $1 + 1 = ?$). In China, however, whole number arithmetic involves much more. For example, it is expected that students explore the quantitative relationships among the operations (e.g. given that $1 + 1 = 2$, then $2 - 1 = ?$) and represent these (sometimes quite sophisticated) relationships with (sometimes quite complicated) numerical equations.

As mentioned in the article ‘A critique of the structure of U.S. elementary school mathematics’ (Ma 2013), part of this difference in perspectives is due to a theory that underlies school arithmetic in China and several other countries.¹ Although this theory underlies present-day school arithmetic in China, an important stage of its development occurred in Europe and the USA, initiated by the spread of mass education in the middle of the nineteenth century. This significant social

Author Contributions: LM conducted the textbook and historical analysis. LM and CK wrote the article.

¹Textbook analyses point out specific aspects of this general difference (Ding and Li 2010; Ding et al. 2013).

L. Ma (✉)

Independent Scholar, Shanghai, China, and Palo Alto, CA, USA

e-mail: maliping51@gmail.com

C. Kessel (✉)

Consultant, Berkeley, CA, USA

e-mail: cbkessel@earthlink.net

© The Author(s) 2018

M.G. Bartolini Bussi, X.H. Sun (eds.), *Building the Foundation: Whole Numbers in the Primary Grades*, New ICMI Study Series, https://doi.org/10.1007/978-3-319-63555-2_18

439

change initiated a significant change in arithmetic, which we briefly outline here.² Mid-nineteenth-century primary school textbooks such as *Warren Colburn's First Lessons in Intellectual Arithmetic* included Arabic numerals and notation for whole numbers, fractions and operations on them, inherited from commercial arithmetic textbooks for adults such as *Cocker's Arithmetick* (first published in 1677), which focused on efficient computation.

From this school arithmetic, mathematical scholars began to forge an academic subject more closely connected to the rest of mathematics. They introduced two important new features:

- Horizontal expressions. These allowed significantly more sophisticated quantitative relationships to be expressed than did the vertical columns used for the calculations of commercial arithmetic.³
- A system of definitions and axioms modelled on that of Euclid's *Elements*.⁴ These included the definition of a number as a collection of units. Most included 'rules of likeness' such as the rule that 'only like numbers can be added'. Some included compensation principles or the commutative, associative and distributive properties, but not necessarily both.⁵

The significance of this system in connecting arithmetic with the rest of mathematics is hard to underestimate. In assessing the impact of the *Elements*, the mathematician Bartel van der Waerden (1978/2015) wrote:

Almost from the time of its writing, the *Elements* exerted a continuous and major influence on human affairs. It was the primary source of geometric reasoning, theorems, and methods at least until the advent of non-Euclidean geometry in the 19th century. It is sometimes said that, other than the Bible, the *Elements* is the most translated, published, and studied of all the books produced in the Western world. Euclid may not have been a first-class mathematician, but he set a standard for *deductive reasoning* and geometric instruction that persisted, practically unchanged, for more than 2,000 years. (emphasis added)

At the beginning of the twentieth century, the system of definitions and axioms was almost complete, as can be seen by examining US textbooks. Its development in the USA did not continue, possibly due to decreased emphasis on 'mental discipline' and increased concern about high failure rates (Stanic 1986; Stanic and Kilpatrick 1992). However, as evidenced in textbooks of other countries, development of the system continued outside the USA.⁶

²Ma (in preparation) gives a detailed account.

³The prolific textbook author and translator Charles Davies seems to have initiated this change in US primary mathematics textbooks; see his *Common School Arithmetic* (1834, pp. 17, 33). Use of horizontal expressions was further developed in later textbooks such as *Robinson's Progressive Practical Arithmetic* (1875) and *Sheldons' Complete Arithmetic* (1886).

⁴The first instance in US arithmetic textbooks may be in *School Arithmetic: Analytical and Practical* (Davies 1857). Further developments can be seen in *Sheldons' Complete Arithmetic*.

⁵For example, *The Normal Elementary Arithmetic* (1877) states, 'The sum is the same in whatever order the numbers are added' (p. 208) and 'If the multiplicand be multiplied by all the parts of the multiplier, the sum of all the partial products will be the true product' (p. 223).

⁶Xu notes that, in the first major period of textbook development after 1950, China was 'translating and modifying textbooks from the Soviet Union' (Xu 2013, p. 725). Before 1950, China's school

During the twentieth century, school arithmetic evolved in three ways:

- The system of definitions and rules was augmented by the commutative, associative and distributive properties.
- Prototypical word problems with variants were added, e.g. pursuit, cistern, or work problems (see Ma 2013, Appendix).
- Instructional approaches advanced (see Ma n.d.).

This chapter discusses the first item in this list. In it, we present the central pieces of the theory – the definition system and axioms for whole numbers – distilled from the textbooks of the nineteenth-century USA and twentieth-century China listed in the references. (Details of this development are discussed by Ma [in preparation](#).) The theory built around these central pieces explains all the computational algorithms in whole number arithmetic. Moreover, it can foster primary students' ability to deal with quite sophisticated quantitative relationships.

18.2 Characteristics of the Theory

Like the *Elements*, the theory has definitions, postulates and theorems. It presents a small number of fundamental definitions and shows how other definitions can be derived from those in order to avoid circularity. Its analogue to the postulates of the *Elements* is 'basic rules and basic laws'. Its analogue for theorems is rationales for computational algorithms. The theory differs from the *Elements* in not giving explicit analogues to Euclid's 'common notions' (e.g. 'Things which are equal to the same thing are also equal to each other'). As will be illustrated in this chapter, the common notions were implicitly assumed and used.

The theory differs from modern mathematical theories in several other ways.

First, it follows the *Elements* in style, using only words and diagrams. The advantage of this formulation is its closeness to everyday life. Pedagogical instantiations of this theory, i.e. textbooks, can act as a bridge between lay experiences and the abstractions of formal mathematics.

Second, like the *Elements*, this theory is less precise than modern approaches. Instances of this lack of precision are noted and discussed in this article.

A third difference is that the theory is not intended to be entirely parsimonious. It is parsimonious in giving a small number of fundamental definitions; however, some of the basic laws are redundant. In particular, the laws of compensation can be derived from other basic laws.

mathematics textbooks were influenced by those of other foreign countries. For example, *The Arithmetic Series* by the Japanese mathematician Tsuruichi Hayashi (1926/1933) was translated into Chinese and used in schools during the 1920s and 1930s. There were also Chinese textbooks that were strongly influenced by US 'progressive education', for example, *The New Ideology Arithmetic Series* (Yang and Tang 1931) and *The New Curriculum Standard Arithmetic Series* (Zhao and Qian 1933). In all of these textbooks with various foreign impacts, however, important features of the theory of school arithmetic, such as emphasis on the relationships among the four operations, can be identified.

18.3 Content and Organisation of This Chapter

We present the definitions and basic laws for whole numbers. The definitions are presented in order, that is derived definitions appear after those on which they depend, followed by a list of the basic laws in the Appendix. The general definitions are numbered.

Definitions like those presented here were given in nineteenth-century US textbooks. After the pedagogical advances of the twentieth century, however, explicit (and sometimes complicated) definitions like these were not presented to children. The numbered pedagogical remarks that follow each definition note ways in which it may be presented to children. Historical remarks that discuss sources and variants are given in the footnotes.

18.4 The Arena of Primary School Arithmetic

18.4.1 Units

Definition 1 A single thing, or one, is called a *unit* or *unit one*.

A group of things or a group of units, if considered as a single thing or one, is also called a *unit*, a *unit one* or a *one* (Fig. 18.1).

One or one thing is a primitive conception that we are born with. The definition of unit is abstracted from this conception. This is the starting point of the definition system.

In this definition, we see two types of unit. The first type we call ‘one-as-one unit’ and the second ‘many-as-one unit’.

Although the concept is called ‘unit’, use of the terms ‘unit one’ and ‘one’ in teaching helps to connect ‘unit’ with students’ conception of ‘one’.

Students’ understanding of the concept of unit deepens step by step through arithmetic learning. They shouldn’t be expected to read or know abstract definitions such as the definition above.

As students progress through primary mathematics, their concept of unit becomes more abstract. Although this deepening of the concept of unit occurs throughout primary mathematics, the term ‘unit’ is generally not used until middle and upper

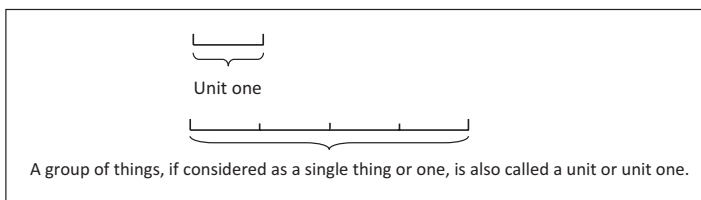

Fig. 18.1 The definition of unit

primary grades. In those grades, students may need to use the terms ‘unit’ and ‘unit one’ when solving certain kinds of word problems, some of them involving multiplication and division of fractions.

18.4.2 Numbers

Definition 2 A *number* is a unit (one) or a collection of units (ones).

This definition of number is given in terms of the definition of unit. It generates one set of numbers, the natural numbers (1, 2, 3, etc.). This chapter does not discuss how the definition of unit will expand to generate a second set of numbers, expanding the number system of primary mathematics. Together, the two sets of numbers, natural numbers and positive rational numbers, form the arena of school arithmetic.

The symbol 0 has two features: as a digit in the notation system and as a number. As a digit, it plays an important role in the notation system. But, as a number, 0 is not part of the arena of school arithmetic.⁷

This definition generates the natural numbers, the set of numbers already familiar to students. Primary students are not expected to learn a separate definition for ‘number’.

Definitions 3 and 4 An *abstract number* is a number whose units are not named.

A *concrete number* is a number whose units are named.

To classify numbers as concrete and abstract is a need specific to school arithmetic. The terms *abstract number* and *concrete number* were created after a long-term effort of primary teachers with the assistance of mathematical scholars.⁸

When they begin school, most primary school students do not have conceptions of abstract numbers such as ‘five’, ‘six’ or ‘seven’. Instead, their conceptions are concrete numbers such as ‘five friends’, ‘six books’ and ‘seven apples’. An important task of primary mathematics is to lead students to complete their transition from concrete number to abstract number and be able to compute with abstract numbers. During this process, students’ original conception of concrete number serves as an

⁷How many aspects of the number zero should be taught in primary school is an issue which needs further discussion. Consider Alfred North Whitehead’s remark: ‘The point about zero is that we do not need to use it in the operations of daily life. No one goes out to buy zero fish. It is in a way the most civilized of all the cardinals, and its use is only forced on us by the needs of cultivated modes of thought’ (1948, p. 43).

⁸Smith wrote: “The distinction between abstract and concrete numbers is modern. The Greek arithmeticians [who studied number theory] were concerned only with the former, while the writers on logistic [arithmetic] naturally paid no attention to such fine distinctions. It was not until the two streams of ancient number joined to form our modern elementary arithmetic that it was thought worth while to make this classification, and then only in the elementary school. [...] The terms ‘abstract’ and ‘concrete’ were slow in establishing themselves. The mathematicians did not need them, and the elementary teachers had not enough authority to standardize them” (1925/1953, pp. 11–12).

important resource for instruction.⁹ The concept of concrete number can also serve as cornerstone in learning to analyse quantitative relationships.

The terms ‘abstract number’ and ‘concrete number’ are not terms that students should be expected to know. However, they denote concepts that are important for teachers, curriculum designers, and textbook authors in describing students’ mathematical development and in designing instruction to help students develop more abstract thinking.

Definition 5 Like numbers

If two concrete numbers have units with the same name, they are called *like numbers*.

The concept of like numbers is a useful support for students as they learn to analyse quantitative relationships.

18.5 Notation: Base-Ten Positional Numeral System

18.5.1 Digits and Numerals

Digits are symbols used to represent numbers. There are nine significant digits and one non-significant digit.

Each of the nine significant digits represents a different number of units:

1	2	3	4	5	6	7	8	9
One	Two	Three	Four	Five	Six	Seven	Eight	Nine

The non-significant digit is 0. It represents no units.

A sequence of digits is called a *numeral*.

A numeral can have one or more digits. A number represented by a numeral with only one digit is called a one-digit number. A number represented by a numeral with two digits is called a two-digit number. A number represented by a numeral with three digits is called a three-digit number, and so on.

Because there are only nine significant digits, one digit cannot represent more than nine units.

⁹For example, the book *First Lessons in Intellectual Arithmetic*, by Warren Colburn (1793–1833), a Harvard mathematics baccalaureate, gave examples of how this resource could be used. It was published in 1821 and was in ‘almost universal use’ for several decades (Monroe 1912, p. 424). By 1890, 3,500,000 copies had been sold in the USA (Cajori 1890). Ninety years after its publication in 1912, it was still being used in the USA (Monroe 1912, p. 424). The impact of *First Lessons* was not confined to the USA. *First Lessons* was translated into several European languages and distributed in Europe (*Scientific American Supplement*, No. 455, September 20, 1884). Missionaries translated it into Asian languages and distributed it in some Asian countries. During the mid-nineteenth century, the book sold 50,000 copies per year in England (Monroe 1912, p. 424).

Although there are only ten different digits, every natural number can be represented as a numeral.

18.5.2 *Place of a Digit, the Unit Value of a Digit, the Name of a Place and Place Value*

The position of a digit in a numeral is called the *place* of a digit. The largest digit in any place represents nine units. Each ten units is written as one unit in one place to the left.

Digits at different positions have different unit values. For numerals with two or more digits, the unit value of a place is ten times the unit value of the place immediately to its right.

The places are named according to the value of the unit they represent. From right to left: ones place, tens place, hundreds place, etc.

The unit value determined by the position of the digit is also called the value of the place or place value. In arithmetic with natural numbers, these values are powers of ten: 1, 10, 100, 1000, etc.

The digits in a numeral are named according to their positions: ones digit, tens digit, hundreds digit, etc.

Positional notation is one of several kinds of notation for numbers.¹⁰ A key feature of positional notation is that the place of a digit determines the unit value represented by the digit. In school arithmetic, only one kind of positional notation is taught, base-ten notation. Concepts of positional notation are introduced in the specific context of this notation rather than in a general way (Fig. 18.2).

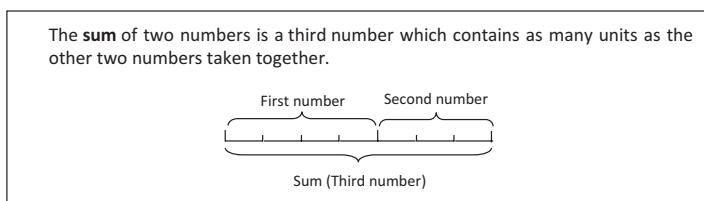

Fig. 18.2 The definition of the sum of two numbers

¹⁰In addition to positional notation, there are other types of notation systems for numbers such as Roman numerals and Chinese notation.

18.6 Addition and Subtraction

18.6.1 Addition

Definition 6 The *sum* of two numbers¹¹ is a third number which contains as many units as the other two numbers taken together.

The operation of finding the sum of two numbers is called *addition*.¹²

The definition of ‘sum’, one of the two basic quantitative relationships in school arithmetic, is given in terms of the definitions of ‘unit’ and ‘number’.

The quantitative relationship formed by three numbers has the following feature. If two of the three numbers are known, the third is determined. Because of this, it is possible to define addition and subtraction in terms of this quantitative relationship.

Although the definition of the sum of two numbers may seem obscure, it reveals the key relationship that underlies addition and subtraction in school arithmetic. The line segment diagram in Fig. 18.2 represents this definition in a form that is suitable for teaching.

After the quantitative relationship of sum is defined, then addition can be defined in terms of this relationship. In a similar way, subtraction can be defined. In this way, the connection of sum, addition and subtraction is given explicitly, using a small collection of fundamental concepts.

It is very likely that the concept of addition is closely related to a primitive conception that we are born with. A contemporary cognitive science researcher Karen Wynn (1992, 1995) has published research to demonstrate that several weeks after birth, infants can recognise the quantities 1, 2 and 3 and do computations such as $1 + 1$ and $2 - 1$ (see also, National Research Council 2009, p. 65). By the time primary children come to school, they may have developed a variety of strategies for addition: counting all, counting on or using known sums (National Research Council 2001, p. 169). Often, they find it easier to convert subtraction computations to addition computations by counting on, e.g. to compute $8 - 5$, count up from 5, ‘6, 7, 8. So 3 left’ (National Research Council 2001, p. 190). The nineteenth-century textbook author Warren Colburn may have been noting this phenomenon when he wrote, ‘It is remarkable that a child, although he is able to perform a variety of examples which involve addition, subtraction, multiplication, and division, recognizes no operation but addition’ (1821/1863, p. 9).

The task of teaching is to make a bridge from the inborn conception to the abstract quantitative relationship sum of two numbers.

¹¹ Natural numbers do not include zero.

¹² Addition and subtraction are binary operations. A binary operation is a calculation involving two input quantities. While the sum of three and more numbers can be computed, it needs to be found step by step, at each step computing the sum of two numbers.

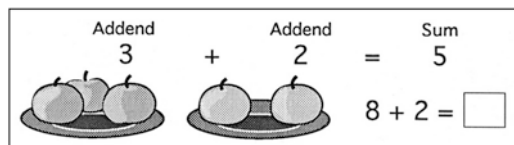

Fig. 18.3 Example of introducing definition and terms of addition to first-grade students (Moro et al. 1992, p. 38) (Reprinted with the permission of the University of Chicago School Mathematics Project)

18.6.1.1 Addends

Definition 7 The two numbers summed are called *addends*.¹³

The two terms ‘addend’ and ‘sum’ are important thinking tools to understand and work with the quantitative relationship ‘sum of two numbers’. Students should be exposed to them at the beginning of their addition and subtraction learning. Figure 18.3 is an example from a Grade 1 Russian mathematics textbook (the addition on the right $8+2$) is a new problem to be solved). It introduces the definition of the sum of two numbers, the definition of addition and the definitions of ‘addend’ and ‘sum’ in a form suitable for young children. (For more details of how this may occur in teaching, see [Ma n.d.](#), pp. 15–16.)

Some early primary teachers tell their students that because the sum is greater than the addends, if we see that the result of a word problem will be greater than the known numbers in the problem, we use addition to solve the problem. This approach, when compared with the approach of looking for keywords such as ‘left’, ‘together’, ‘more’ or ‘less’, is more conceptual. However, it needs to be noted that this approach is only useful for one-step word problems.¹⁴ Therefore, at an appropriate point, we need to lead students to notice the limitations of this statement. By noticing these limitations, students gain the experience of developing new knowledge by understanding limitations of knowledge developed earlier.

18.6.1.2 The Rule of Like Numbers for Addition

When two addends are concrete numbers, they must be like numbers. Their sum and the two addends are like numbers.

¹³Terms of the definition system such as ‘like numbers’ in section I, in this section, ‘sum’ and ‘addends’, and in the next section ‘product’, ‘multiplicand’ and ‘multiplier’ all first appeared in arithmetic textbooks during the past 400 years. Over the years, various definitions have been given for these terms. These definitions were not always given as part of a system in which definitions depend on a few fundamental definitions but instead as definitions that were independent of each other.

¹⁴When we solve multi-step word problems, when the result is larger than the known numbers, we may need to use operations other than addition.

There are two rules of likeness: rule of like number and rule of like unit. Of these two, the rule of like numbers is more closely connected with quantitative relationships.

The rule of like numbers for addition seems very simple. It is easily ignored. Its importance is more noticeable from the perspective of the entire theory.

In teaching, this rule can be said as ‘addends must be like numbers’ or ‘only like numbers can be added’.

18.6.1.3 The Rule of Like Unit Value for Addition

In computing the sum of two numbers, their representations as numerals are used. Only digits of like unit value can be added.

This rule is part of the explanation of the algorithm for multi-digit addition. For example, the digit 5 in the ones place and the digit 3 in the ones place have the same unit value so they can be added. The digit 5 in the ones place and the digit 3 in the tens place do not have the same unit value and cannot be added.

This rule is also an important part of the explanation of the algorithm for multi-digit multiplication.

In teaching, we can say ‘only digits with the same units can be added’ or ‘only the same units can be added’, omitting the word ‘value’ which is not relevant to students and omitting the distinction between number and numeral.

18.6.2 Subtraction

Definition 8 If a sum and one addend are known, the operation of finding the unknown addend is called *subtraction*.

Subtraction is the inverse of addition in the sense that it ‘undoes’ addition.

Defining subtraction and addition in terms of ‘the sum of two numbers’ connects the two operations of subtraction and addition with one quantitative relationship. However, there is a difference between the conceptions of subtraction that students already have developed on their own and this definition of subtraction. Teaching needs to start from these conceptions and gradually lead students to see the quantitative relationship that underlies the operations of addition and subtraction.

It is possible to introduce this definition of subtraction early in arithmetic learning in a form suitable for students (see Ma, n. d., pp. 18–20). Figure 18.4 illustrates two stages of the path between students’ conceptions of subtraction and the quantitative relationship in first grade (Moro et al. 1992/1982, pp. 15, 55).

At early stages of learning subtraction, there are two instructional approaches: learning the operation of subtraction and also leading students to pay attention to the relationship between addition and subtraction. These different approaches will have different impacts on students’ later learning.

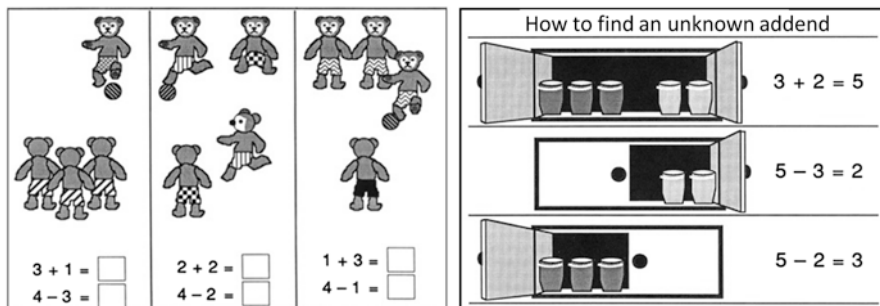
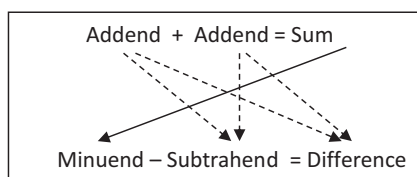

Fig. 18.4 Two stages in first-grade subtraction (Reprinted with the permission of the University of Chicago School Mathematics Project)

Fig. 18.5 The correspondence between terms in addition and subtraction



18.6.2.1 Minuend, Subtrahend, Difference

Definition 9 The known sum in subtraction is called the *minuend*. The known addend is called the *subtrahend*. The unknown addend, which is the result of the operation of subtraction, is called the *difference*.

Like the concepts ‘addend’ and ‘sum’, the concepts ‘minuend’, ‘subtrahend’ and ‘difference’ are important thinking tools for understanding and working with the quantitative relationship ‘sum of two numbers’. Students do not need to memorise the definitions, but they need to have terms to use for the things described in the definitions, allowing them to describe how the terms are related. For example, the sum in an addition equation corresponds to the minuend in a subtraction equation¹⁵ (Fig. 18.5).

Because a minuend is greater than a corresponding difference, early primary teachers tend to tell students that if we see that the result of a word problem will be smaller than the known numbers in the problem, we use subtraction to solve the problem. However, as with addition, it needs to be noted that this approach is only useful for one-step word problems.

¹⁵This is an example of two definitions that depend on a more fundamental definition. Rather than being defined independently, subtraction and addition are both defined in terms of the relationship ‘sum of two numbers’. Figure 18.5 illustrates one consequence: terms for parts of an addition equation have an explicit correspondence with terms for parts of a subtraction equation.

18.6.2.2 The Rule of Like Numbers and the Rule of Like Units for Addition Applied to Subtraction

When minuend and subtrahend are concrete numbers, they must be like numbers. Their difference, the minuend and the subtrahend are also like numbers.

This is the rule for subtraction that corresponds to the rule of like numbers for addition. In teaching, this rule can be said as ‘minuend and subtrahend must be like numbers or only like numbers can be subtracted’.

When computing a difference, only digits of like unit value can be subtracted.¹⁶

This is the rule for subtraction that corresponds to the rule of like unit value for addition.

This rule is part of the explanation of the algorithms for multi-digit subtraction and for long division. In teaching, we can say ‘only digits with the same units can be subtracted’ or ‘only the same units can be subtracted’.

18.6.3 The Three Cases for Unknown Number in the Relationship ‘Sum of Two Numbers’

The quantitative relationship ‘sum of two numbers’ concerns three numbers. When two are known, the third can be found. The three cases are:

- A. The two addends are known, to find the sum. (In terms of subtraction: the subtrahend and difference are known, to find the minuend.)
- B. The sum and the first addend are known, to find the second addend. (In terms of subtraction: the minuend and subtrahend are known, to find the difference.)
- C. The sum and the second addend are known, to find the first addend. (In terms of subtraction: the minuend and subtrahend are known, to find the difference.)

In Fig. 18.6, the diagram on the left represents the relationship ‘sum of two numbers’. On the right are the three possible cases for one number to be unknown in this relationship. All addition and subtraction word problems in school arithmetic, whether single- or multi-step, that ask students to find one unknown can be built from these three forms.

¹⁶Because the Arabic numeral system can only represent one ten but not ten ones, the explanation of the rationale for subtraction with borrowing cannot be represented completely in Arabic numerals. For example, $235 - 117$ the five ones in the ones place of the minuend are insufficient for conducting the operation. The first step is to convert one unit at the tens place of the minuend into ten ones. The next step can occur in two ways. One is to subtract the seven ones from the ten ones, resulting in three ones, and add the five ones, to find the digit (8) in the ones place of the difference. The second way is to combine the ten ones and the five ones, making fifteen ones, and then subtracting the seven ones from fifteen ones. The ten ones and fifteen ones cannot be represented with Arabic numerals without additional conventions or notation.

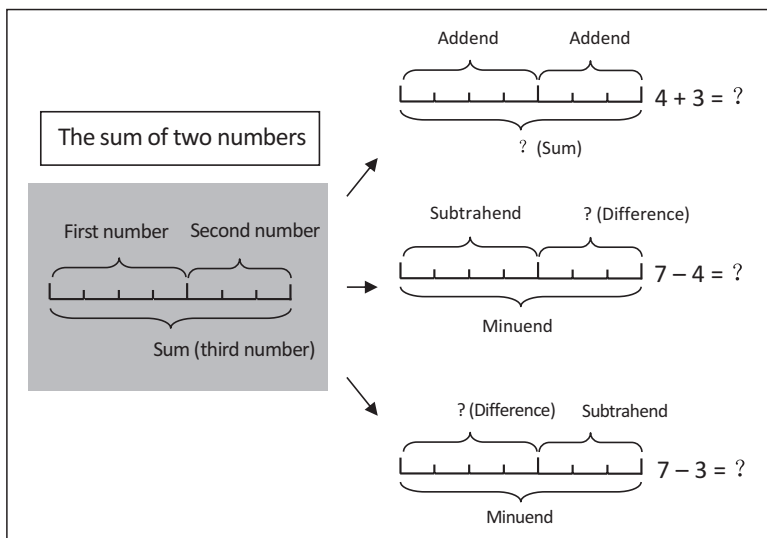

Fig. 18.6 Addition and subtraction derived from the quantitative relationship ‘sum of two numbers’; terms used in addition and subtraction

According to the Common Core State Standards (2010), there are four main categories of one-step addition and subtraction word problems. In China, there are five categories for such problems.¹⁷ No matter how word problems are categorised or named, each kind is a direct or indirect representation of one of the three forms. Those represented indirectly use the approach of ‘equivalent substitution’ (Fig. 18.7), illustrated by the following example:

James caught three fish, Henry caught five fish, how many more fish did Henry catch?

At first glance, this problem does not correspond to any of the three cases in Fig. 18.6. But, if we analyse the quantitative relationship in the problem, we will find that the problem corresponds to the second case. (Here Euclid’s first common notion, ‘Things which equal the same thing also equal one another’, is implicitly used.)

¹⁷The five categories are finding the sum, finding an amount that remains, finding an unknown which is a given amount larger than a known number, finding an unknown which is a given amount smaller than a known number and finding a difference. (See *Research and Practice in Teaching Elementary Arithmetic Word Problems*, 1994.) The Common Core State Standards list four main categories, each with three subcategories that depend on the position of the unknown. The categories are Add To (result unknown, change unknown and start unknown); Take From (result unknown, change unknown and start unknown); Put Together/Take Apart (total unknown, addend unknown, both addends unknown); and Compare (difference unknown, bigger unknown and smaller unknown, each with two language variants: how many more? vs how many fewer?).

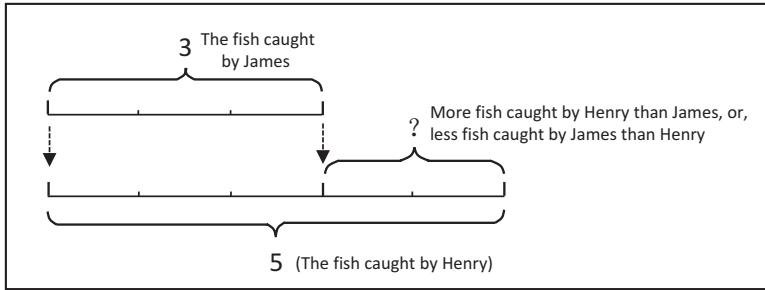

Fig. 18.7 Example of ‘equivalent substitution’ in ‘sum of two numbers’

18.7 Multiplication and Division

18.7.1 Multiplication

Definition 10 The *product* of two numbers is a third number which contains as many units as one number taken as many times as the units in the other.

The operation of finding the product of two numbers is called *multiplication*. (For example, how much is three taken four times?)

This quantitative relationship is obviously more sophisticated than that of the sum of two numbers. First of all, there is a new type of unit in this relationship: in Fig. 18.8, each copy of the first number is a new ‘many-as-one’ unit created by considering a group of units as a single thing.¹⁸

Second, unlike the relationship ‘sum of two numbers’, the product of two numbers involves two types of units: ‘one-as-one’ and ‘many-as-one’ units. This is illustrated by Fig. 18.8.

Third, in Fig. 18.8, the units of the second number determine the number of copies of the first number. The ‘one-as-one’ units in the collection of copies form the third number, which is the product.

The definition of product of two numbers above is not equivalent to considering the product as the result of repeated addition. This definition is also not equivalent to the definition of Cartesian product because it involves the creation of a new type of unit rather than a collection of pairs of units.

In teaching, multiplication is often introduced with repeated addition. When students see $4 + 4 + 4$ as ‘4 added to 4, added to 4’, they are using the concept of addition. When students can recognise $4 + 4 + 4$ as three 4s, they start to develop the concept of multiplication. We should help students to accomplish this transition as soon as possible.

Although it is likely that the concept of addition is closely related to an inborn primitive conception, the concept of multiplication is not. In forming the concept of

¹⁸This ‘many-as-one’ unit is a unit, due to Definition 1: ‘A group of things, if considered as a single thing or one, is also called a *unit*’.

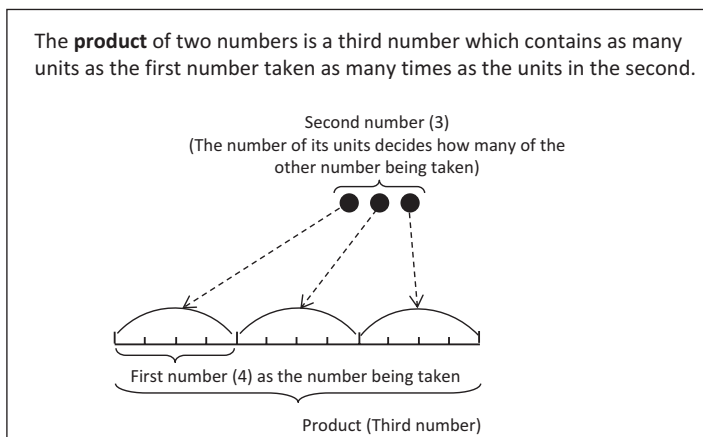

Fig. 18.8 The definition of product of two numbers

multiplication, there are three stages of learning. First, being able to consider many as one, such as one group, one class and one basket of things. Second, being able to imagine several many-as-one units, such as several groups, classes or baskets of things (all of the same size). Third, when analysing quantitative relationships, being able to manage the two types of units at the same time.

In human history, there is a long gap between the development of addition and the development of multiplication. For students, there is also a gap. One task of school arithmetic is to give students a pathway across that gap.

18.7.1.1 Multiplicand, Multiplier and Factors

Definition 11 *Multiplicand* is the number to be taken. The *multiplier* is the number that indicates how many times the multiplicand is taken.

Multiplicand is the number represented by the first term in a multiplication expression. It is represented by the term at the left of the multiplication sign.

The multiplicand is the number being taken. Its copies are the newly formed many-as-one units. For students, this is their earliest use of many-as-one units.

For the past few hundred years, the multiplicand has traditionally been represented as the first term in multiplication.¹⁹ This tradition of giving the multiplicand

¹⁹According to the *Oxford English Dictionary*, the terms ‘multiplicand’ and ‘multiplier’ first appeared in 1592 and 1542. In early arithmetics, multiplication was often written vertically with the multiplicand above the multiplier. One very widespread textbook, *Cocker’s Arithmetic*, first published in 1677, said, ‘Multiplication has three parts. First, the multiplicand. . . . Second, the multiplier. . . . And thirdly, the product’ (1677, p. 32). In the nineteenth century, this description was repeated by Charles Davies in his textbook (Davies 1857, p. 45). Davies used horizontal expressions, writing the multiplicand to left of the multiplication sign (Davies 1834, p. 33).

first is consistent with its role in commercial arithmetic.²⁰ In the definition system, giving the multiplicand first is consistent with the emphasis on the concept of unit.

When introducing multiplication with repeated addition, students should notice that the multiplicand is the addend.

The multiplier is represented by the third term in a multiplication expression. It is represented by the term at the right of the multiplication sign.

The multiplier is always an abstract number.

A multiplication expression is read as ‘multiplicand multiplied by multiplier’ or ‘multiplier times multiplicand’ (e.g. 5×3 read as ‘5 multiplied by 3’ or ‘3 times 5’).

The multiplier indicates how many copies of the multiplicand are in the product.

Some think that distinguishing between multiplicand and multiplier or reading the expression as described above burdens students with unnecessary detail. But this temporary complication is the price of a simpler future.

When both multiplicand and multiplier are abstract numbers, they are also called *factors*.

In school arithmetic, there are two situations where the distinction between multiplicand and multiplier is irrelevant. First, when factoring. Second, in formulas such as area of a rectangle or triangle, volume of a cube. The latter is the last step of a process that begins by depending on the distinction between multiplier and multiplicand.

Although the distinction between multiplicand and multiplier does not remain throughout primary mathematics, it is important because it helps students to be aware of the new type of unit, thus helping to expand their conception of unit.

18.7.1.2 The Rule of Like Numbers for Multiplication

When the multiplicand is a concrete number, the multiplicand and the multiplier are not like numbers. In that case, the product and the multiplicand are like numbers.

Analysing quantitative relationships in school arithmetic is practised mainly by solving word problems. Most numbers in word problems are concrete numbers. For example:

- A. There are 24 books on the shelf. Bill puts six more books on the shelf. How many books are there now? The solution is 30 books.
- B. There are 24 books on a shelf. How many books are there on six shelves? The solution is 144 books.

Problem A is to find the sum. The solution and the addends are all like numbers.

Problem B is to find the product of two numbers. The two concrete numbers presented in the problem, 24 books and 6 shelves, are not like numbers. The former is the number being taken, the multiplicand. The latter, the multiplier, determines

²⁰In commerce, the seller first sets the price per unit, then the total price of multiple units is computed each time a sale is made.

that there are six 24-book groups. The product, 144 books, and the multiplicand are like numbers. This is consistent with the like number rule for multiplication: When the multiplicand is a concrete number, the multiplicand and the multiplier are not like numbers. In that case, the product and the multiplicand are like numbers.

Although 6 shelves is a concrete number, as a multiplier, it is treated as an abstract number.

18.7.2 Division

Definition 12 If a product and one of the multiplicand or multiplier are known, the operation of finding the unknown multiplier or, respectively, multiplicand is called *division*.

Division is also the operation of finding the unknown factor when the product and one factor are known.

Division is the inverse of multiplication in the sense that it ‘undoes’ multiplication.

Defining multiplication and division in terms of ‘product of two numbers’ connects the two operations of division and multiplication with one quantitative relationship, in a way that is similar to the connection between subtraction and addition. However, because multiplicand and multiplier may be different types of numbers, there are several possible forms for the inverse operation.

Definition 13 To find an unknown multiplicand is called *partitive division*.

For example, 12 apples are equally shared among 3 children. How many does each child get? (Partition 12 into three pieces. How many in each piece?)

To find an unknown multiplier is *quotitive division*.

For example, there are 12 apples. Give each child 4 apples. How many children can get apples? (How many 4s are there in 12? 12 is how many times as many as 4?)

To find an unknown factor is neither quotitive nor partitive division.

For example, the area and length of a rectangle are known. Find the width.

We may say, ‘For example, the product of two factors is 15. One factor is 5, what is the other factor?’

18.7.2.1 Dividend, Divisor, Quotient, Remainder

Definition 14 The known product in division is called the *dividend*.

A known multiplicand, multiplier or factor is called the *divisor*.

The unknown, which is the result of the operation of division, is called the *quotient*.

The correspondence between terms in multiplication and division is illustrated in Fig. 18.9.

Fig. 18.9 The correspondence between terms in multiplication and division

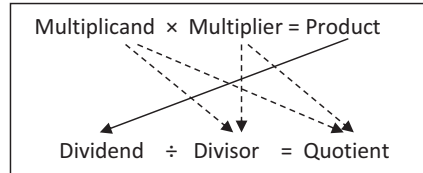

The dividend may be the sum of a product where one factor is the divisor and a number smaller than the divisor. The latter is called the *remainder*. In this case, the result of division has two parts: quotient and remainder.

Remainder is a temporary term in school arithmetic. After fractions are introduced, there is no longer a need for this term.

18.7.2.2 The Rule of Like Numbers for Multiplication Applied to Division

In partitive division, dividend and quotient are like numbers.

In quotitive division, dividend and divisor are like numbers.

The rule of like numbers can help students recognise quantitative relationships.

18.7.3 *The Three Cases for Unknown Number in the Relationship ‘Product of Two Numbers’*

The quantitative relationship ‘product of two numbers’ concerns three numbers. When two are known, the third can be found (Fig. 18.10). The three cases are:

- The multiplicand and multiplier are known, to find the product. (In terms of division: the divisor and quotient are known, to find the dividend.)
- The product and the multiplicand are known, to find the unknown multiplier. (In terms of division: the dividend and quotient are known, to find the unknown divisor.)
- The product and the multiplier are known, to find the multiplicand. (In terms of division: the dividend and divisor are known, to find the unknown quotient.)

18.8 Concluding Remarks

The definition system and basic laws for whole numbers discussed above form the core of the theory of school arithmetic. The remaining content in this theory – the definition system for fractions and theorems in school arithmetic (analogous to the propositions in the *Elements*) – is built on this foundation.

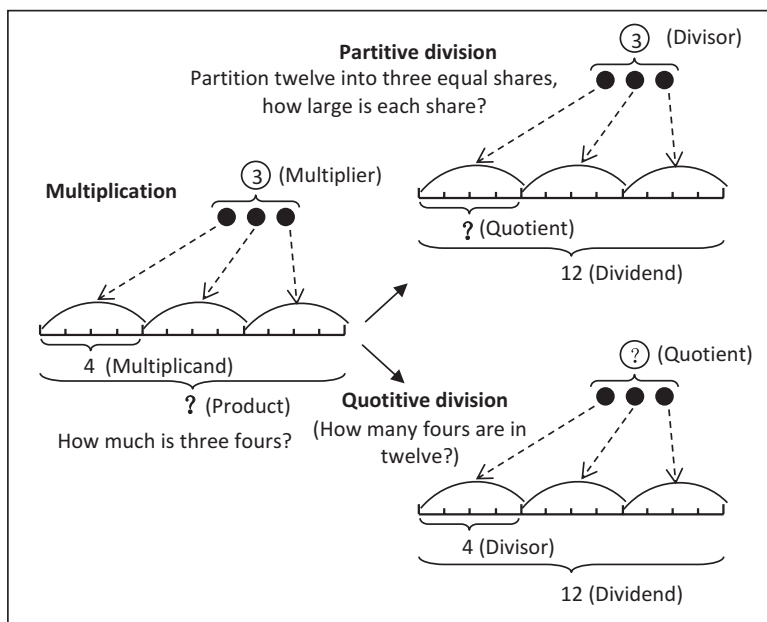

Fig. 18.10 Multiplication, partitive and quotitive divisions

Returning to the puzzle of the US and Chinese teachers' responses, we briefly sketch examples of connections – or lack thereof – with the theory.

The teachers responded to the question of what students needed to know about subtraction with regrouping in two ways. Nineteen of the 23 US teachers focused on the procedure of borrowing, speaking of taking one ten from the tens place and exchanging it for ten ones (Ma 2010, p. 2). Their explanations did not connect the procedure with a correct rationale and sometimes suggested that the digits representing ones and tens were two independent numbers rather than representations of two parts of a number. In contrast, the other four teachers noted that students should understand that exchanging one ten for ten ones did not alter the value of the minuend. The rationale for such exchanges relies on Definition 2 – 'a number is a collection of units' – and the notational conventions described in Section II about how these units are represented as tens and ones. Like their US counterparts, some Chinese teachers focused on the procedure of borrowing (p. 7). Most, however, focused on the idea of regrouping, describing the exchange of one ten for ten ones as 'decomposing a unit of higher value' (pp. 8–10). This description expresses a general feature of base ten notation and can be used not only for exchanges of 1 ten for 10 ones but many others, e.g. 1 hundred for 10 tens and 1 one for 10 tenths.

In discussing 123×645 , many US and few Chinese teachers gave only a procedural account of the multiplication algorithm. Conceptual explanations from both countries fell into two categories: place value system and meaning of multiplication and – implicitly or explicitly – the distributive property. Two US teachers explained the rationale for the multiplication algorithm in terms of the meanings of base ten

notation and multiplication. Five other US teachers noted that the problem of computing 123×645 could be reduced to the problem of computing the sum of 123×600 , 123×40 and 123×5 , but none justified this transformation in any way (Ma 2010, pp. 35–36). It may be that the US teachers had encountered the distributive property at some point, perhaps in an algebra course. However, it was not evident in their responses. In contrast, about one third of the Chinese teachers used a similar approach (pp. 39–42). A difference was that they presented the transformation in a more formal way, and over half referred to the distributive property. The other Chinese teachers gave explanations in terms of the place value system and the units of a number (pp. 42–45), echoing the definitions of unit value of a digit, place value and multiplication presented in this article. A few mentioned both approaches (p. 45).

This is consistent with findings of more recent studies. US primary textbooks and teachers guides published in 2004 and 2005 treat the distributive property in less depth than their Chinese counterparts (Ding and Li 2010). Prospective US primary teachers sometimes confuse the associative property with the commutative property, and the textbooks that they use in preparation and practice teaching provide little support in this matter (Ding et al. 2013).

More such connections could be traced, and more details could be given (Ma in preparation). However, we wish to end by emphasising the point that teachers' knowledge may reflect the substance of the school mathematics that they learned as students and teach as teachers. The theory presented in this article was distilled from textbooks of nineteenth-century USA and twentieth-century China (see the textbooks listed in the references). It is not surprising that we can recognise features of the theory in the responses of the Chinese teachers. In contrast, the US teachers' responses seem to reflect an absence of underlying theory in US school arithmetic. Given this absence, it is remarkable that *any* of the US teachers gave conceptual explanations and not surprising that their explanations were not as well elaborated as those of the Chinese teachers.

Appendix: Basic Laws

Commutative Property of Addition and Corresponding Property for Subtraction

Commutative property of addition: if two addends are exchanged, their sum is unchanged.

$$\text{Since } 5 + 3 = 8, \text{ then } 3 + 5 = 8; \text{ or } 5 + 3 = 3 + 5.$$

The corresponding property for subtraction is: the positions of subtrahend and difference can be exchanged.

$$\text{Since } 8 - 5 = 3, \text{ then } 8 - 3 = 5.$$

Associative Property of Addition and Corresponding Property for Subtraction

Associative property of addition: when three numbers are added, the sum of the first two added to the third is the same as the first number added to the sum of the last two. For example, $5 + 3 + 2$:

$$(5 + 3) + 2 = 5 + (3 + 2).$$

The corresponding property for subtraction is: when two numbers are subtracted from a third number, the difference of the sum of the two numbers and the third is the same as the difference of the difference of the first number and the third and the second number. For example, $12 - 3 - 4$:

$$12 - (3 + 4) = (12 - 3) - 4.$$

Compensation Property for Addition

If an addend is increased and the other addend is decreased by the same amount, their sum is unchanged. For example, $5 + 3$:

$$5 + 3 = (5 + 2) + (3 - 2) = (5 - 2) + (3 + 2).$$

Therefore, if one addend increases (or decreases) by a given amount and the other addend is unchanged, then their sum increases (or decreases) by the same amount. For example, $5 + 3 = 8$:

$$\text{Since } 5 + 3 = 8, \text{ then } (5 + 2) + 3 = 8 + 2 \text{ and } (5 + 3) + 2 = 5 + (3 + 2).$$

The corresponding property for subtraction is: if the minuend and subtrahend increase (or decrease) by a given amount, their difference is unchanged. For example, $12 - 7 = 5$:

$$\text{Since } 12 - 7 = 5, \text{ then } (12 + 2) - (7 + 2) = 5 \text{ and } (12 - 2) - (7 - 2) = 5.$$

If the minuend increases (or decreases) by a given amount and the subtrahend is unchanged, their difference increases (or decreases) by the same amount. For example, $12 - 7 = 5$:

$$\text{Since } 12 - 7 = 5, \text{ then } (12 + 2) - 7 = 5 + 2 \text{ and } (12 - 2) - 7 = 5 - 2.$$

If the minuend is unchanged and the subtrahend increases (or decreases) by a given amount, their difference decreases (or increases) by the same amount. For example, $12 - 7 = 5$:

Since $12 - 7 = 5$, then $12 - (7 + 2) = 5 - 2$ and $12 - (7 - 2) = 5 + 2$.

Commutative Property of Multiplication and Corresponding Property for Division

Commutative property of multiplication: if multiplier and multiplicand exchange positions, their product is unchanged. For example, 3×5 :

Since $5 \times 3 = 15$, then $3 \times 5 = 15$; or $5 \times 3 = 3 \times 5$.

The corresponding property for division is: if divisor and quotient exchange positions, their dividend is unchanged. For example, $15 \div 5 = 3$:

Since $15 \div 5 = 3$, then $15 \div 3 = 5$.

Associative Property of Multiplication

Associative property of multiplication: when three numbers are multiplied, the product of the first number with the product of the last two numbers is the same as the product of the product of the first two numbers with the last number. For example, $5 \times 3 \times 2$:

Since $(5 \times 3) \times 2 = 30$, then $5 \times (3 \times 2) = 30$.

The corresponding property for division is: the result of division by one number then dividing by a second number is the same as the result of dividing by the product of the two numbers. For example, $(30 \div 3) \div 2$:

Since $(30 \div 3) \div 2 = 5$, then $30 \div (3 \times 2) = 5$.

Distributive Property

A number multiplied by a sum is the same as the sum of the products of the number with each addend. For example, $5 \times (4 + 3)$:

Since $5 \times (4 + 3) = 35$, then $5 \times 4 + 5 \times 3 = 35$.

Since $5 \times (4 + 3 + 2) = 45$, then $5 \times 4 + 5 \times 3 + 5 \times 2 = 45$.

There is no corresponding property for division.

Compensation Property of Multiplication

If the multiplicand is multiplied by and the multiplier is divided by the same amount, their product is unchanged. For example, 12×9 :

$$\text{Since } 12 \times 9 = 108, \text{ then } (12 \times 3) \times (9 \div 3) = 108 \text{ and } (12 \div 3) \times (9 \times 3) = 108.$$

$$\text{Equivalently, } 12 \times 9 = (12 \times 3) \times (9 \div 3) = (12 \div 3) \times (9 \times 3).$$

Therefore, if the multiplicand is enlarged (or diminished) by a given amount and the multiplier is unchanged, then their product is enlarged (or diminished) by the same amount.

Since $12 \times 9 = 108$, then:

$$(12 \times 3) \times 9 = 108 \times 3$$

$$12 \times (9 \times 3) = 108 \times 3 \text{ and } (12 \div 3) \times 9 = 108 \div 3 \text{ and } 12 \times (9 \div 3) = 108 \div 3.$$

If both the dividend and the divisor are enlarged (or diminished) by a given amount, then their quotient is unchanged. For example, $36 \div 4$:

$$\text{Since } 36 \div 4 = 9, \text{ then } (36 \times 2) \div (4 \times 2) = 9 \text{ and } (36 \div 2) \div (4 \div 2) = 9.$$

Therefore, the dividend is enlarged (or diminished) by a given amount and the divisor is unchanged, and then their quotient is enlarged (or diminished) by the same amount.

If the dividend is unchanged and the divisor is enlarged (or diminished) by a given amount, their quotient is enlarged (or diminished) by the same amount.

Since $24 \div 6 = 4$, then:

$$(24 \times 2) \div 6 = 4 \times 2 \text{ and } (24 \div 2) \div 6 = 4 \div 2 \\ \text{and } 24 \div (6 \times 2) = 4 \div 2 \text{ and } 24 \div (6 \div 2) = 4 \times 2.$$

Acknowledgements Many thanks to Maria G. Bartolini Bussi, Anna Sfard, Xu Hua Sun and Zalman Usiskin for their thoughtful comments on earlier versions of this chapter. Support from the Brookhill Foundation for the writing of this chapter is gratefully acknowledged. This chapter is an outcome of a larger project supported by the Carnegie Foundation for the Advancement of Teaching while Ma was a senior scholar there between 2001 and 2008.

References

Main References

- Cajori, F. (1890). *The teaching and history of mathematics in the United States*. Washington, DC: Government Printing Office.
- Ding, M., & Li, X. (2010). A comparative analysis of the distributive property in U.S. and Chinese elementary mathematics textbooks. *Cognition and Instruction, 28*(2), 146–180.
- Ding, M., Li, X., & Capraro, M. (2013). Preservice elementary teachers' knowledge for teaching the associative property of multiplication: A preliminary analysis. *Journal of Mathematical Behavior, 32*, 36–52.
- Ma, L. (in preparation). *Book manuscript*.
- Ma, L. (2013). A critique of the structure of U.S. elementary school mathematics. *Notices of the American Mathematical Society, 60*(10), 1282–1296.
- Ma, L. (2010). *Knowing and teaching elementary mathematics: Teachers' understanding of fundamental mathematics in China and the United States*. New York: Routledge. (Original work published 1999.)
- Ma, L. (n.d.). *One place addition and subtraction*, <http://lipingma.net/math/One-place-number-addition-and-subtraction-Ma-Draft-2011.pdf>
- Ministry of Education of the People's Republic of China. (2001). 义务教育数学课程标准 [Mathematics curriculum standards for compulsory education (experimental version)]. Beijing: People's Education Press.
- Monroe, W. (1912). Warren Colburn on the teaching of arithmetic together with an analysis of his arithmetic texts: I. The life of Warren Colburn. *The Elementary School Teacher, 12*(9), 421–426.
- National Council of Teachers of Mathematics. (1989). *Curriculum and evaluation standards for school mathematics*. Reston, VA: Author.
- National Governors Association Center for Best Practices, Council of Chief State School Officers. (2010). *Common core state standards for mathematics*. Washington, DC: Author.
- National Research Council. (2001). *Adding it up: Helping children learn mathematics* (J. Kilpatrick, J. Swafford, & B. Findell (Eds.)). Mathematics Learning Study Committee, Center for Education, Division of Behavioral and Social Sciences and Education. Washington, DC: National Academy Press.
- National Research Council. (2009). *Mathematics learning in early childhood: Paths toward excellence and equity* (C. T. Cross, T. A. Woods, & H. Schweingruber (Eds.)). Center for Education, Division of Behavioral and Social Sciences and Education. Washington, DC: National Academies Press
- Song, S. (1994). 宋淑持 [Research and practice in teaching elementary arithmetic word problems]. Shanghai: Shanghai Education Press.
- Smith, D. E. (1925/1953). *History of mathematics* (Vol. II). New York: Dover Publications.
- Stanic, G. (1986). Mental discipline theory and mathematics education. *For the Learning of Mathematics, 6*(1), 39–47.
- Stanic, G., & Kilpatrick, J. (1992). Mathematics curriculum reform in the United States: A historical perspective. *International Journal of Educational Research, 17*(5), 407–417.
- van der Waerden, B. (1978/2015). Euclid. *Encyclopedia Britannica*. Retrieved from <http://www.britannica.com/biography/Euclid-Greek-mathematician>.
- Whitehead, A. N. (1948). *An introduction to mathematics*. London: Oxford University Press.
- Wynn, K. (1992). Addition and subtraction by human infants. *Nature, 358*, 749–750.
- Wynn, K. (1995). Origins of numerical knowledge. *Mathematical Cognition, 1*(1), 35–60.
- Xu, B. (2013). The development of school mathematics textbooks in China since 1950. *ZDM Mathematics Education, 45*(5), 725–736.

References: Textbooks²¹

- Anonymous. (1886). *Sheldons' complete arithmetic, with oral and written exercises*. New York/Chicago: Sheldon & Company.
- Brooks, E. (1877). *The normal elementary arithmetic*. Philadelphia: Sower, Potts & Co..
- Cocker, E. (1677/1745). *Cocker's arithmetic*. London: R. Ware, C. Hitch, and F. Hodges.
- Colburn, W. (1821/1863). *Warren Colburn's first lessons in intellectual arithmetic upon the inductive method of instruction*. Boston: Houghton, Osgood and Company.
- Davies, C. (1834). *The common school arithmetic*. Hartford: H. F. Sumner & Co..
- Davies, C. (1857). *School arithmetic*. New York: A. S. Barnes & Co..
- Fish, D. (1875). *Robinson's progressive practical arithmetic*. New York/Chicago: Ivison, Blakeman, Taylor & Co..
- Hayashi, T. et al. (1926/1933). 算术 [Arithmetic series, 4 vols.] (Y. J. Huang, Trans.). Shanghai: The Commercial Press.
- Hoyt, F., & Peet, H. (1920). *Everyday arithmetic, primary book*. Boston: Houghton Mifflin Company.
- Jury, M., O'Connell, J., & Shallow, E. (1912). *Graded exercises in arithmetic, sixth year—First half*. New York/Cincinnati/Chicago: American Book Company.
- Moro, M. I., Bantova, M. A., & Belyukova, G. V. (1992). *Russian grade 1 mathematics* (9th Ed., R. H. Silverman, Trans.). Chicago: University of Chicago School Mathematics Project. (Original work published 1982).
- Prince, J. (1899). *Arithmetic by grades, for inductive teaching, drilling and testing, book number five*. Boston: Ginn & Company.
- Yang, Y. Q., & Tang, S. G. (1931). 新主义算术 [The new ideology arithmetic series, 4 vols]. Shanghai: Shanghai World Publishing House.
- Zhao, L. Q., & Qian, X. Q. (1933). 新课程算术 [The new curriculum standard arithmetic series, 4 vols]. Shanghai: Chung Hwa Book Company.

²¹Note that many of the nineteenth-century textbooks can be downloaded from the Internet.

Open Access This chapter is licensed under the terms of the Creative Commons Attribution 4.0 International License (<http://creativecommons.org/licenses/by/4.0/>), which permits use, sharing, adaptation, distribution and reproduction in any medium or format, as long as you give appropriate credit to the original author(s) and the source, provide a link to the Creative Commons license and indicate if changes were made.

The images or other third party material in this chapter are included in the chapter's Creative Commons license, unless indicated otherwise in a credit line to the material. If material is not included in the chapter's Creative Commons license and your intended use is not permitted by statutory regulation or exceeds the permitted use, you will need to obtain permission directly from the copyright holder.



Chapter 19

Quantities, Numbers, Number Names and the Real Number Line



Hyman Bass 

19.1 Introduction

The starting point of this paper is a quotation from Davydov's *Types of generalization in instruction: Logical and psychological problems in the structuring of school curricula*, whose original edition in Russian dates back to 1972 and was translated into English in 1990.

When we designed a mathematics course, we proceeded from the fact that the students' creation of a detailed and thorough conception of a *real number*, underlying which is the concept of *quantity*, is currently the end purpose of this entire instructional subject from grade 1 to grade 10. Numbers (natural and real) are a particular aspect of this more general mathematical entity. (Davydov 1990, p. 167)

In our course the teacher, relying on the knowledge previously acquired by the children, introduces number as a particular case of the representation of a *general relationship* of quantities, where one of them is taken as a measure and is computing the other. (Davydov 1990, p. 169)

19.2 Two Conceptions of Quantity: Counting and Measure

Number and operations have two aspects: conceptual (what numbers are) and nominal (how we name and denote numbers). Conceptually, numbers arise from a sense of *quantity* of some experiential species of objects – count (of a set or collection), distance, area, volume, time, rate, etc. And in fact before children enter school, they have already acquired a sense of quantity, of rough comparison of size, as well as of

H. Bass (✉)
University of Michigan, Ann Arbor, MI, USA
e-mail: hybass@umich.edu

counting. Number is not intrinsically attached to a quantity; rather it arises from *measuring* one quantity by another, taken to be the ‘unit’: How ‘much’ (or many) of the unit is needed to constitute the given quantity? This is the *measurement framework* in which fractions are often introduced, via part-whole relations, the whole playing the role of the unit, which is a choice to be made and has to be specified. The discrete (counting) context in which whole numbers are often developed is distinguished by the use of the single-object set as the unit, so that the very concept of the unit, and its possible variability, is not necessarily subject to conscious consideration. This choice is so natural, and often taken for granted, that the concept of a *chosen unit of measurement* need not enter explicit discussion. If number is first developed exclusively in this discrete context, then fractions, introduced later, might appear to be, conceptually, a new and more complex species of number quite separate from whole numbers. This might make it difficult to see how the two kinds of numbers eventually, coherently, inhabit the same real number line. Indeed, this integration entails seeing the placement of whole numbers on the number line from the point of view (not of discrete counting, but) of continuous linear measure.

This distinction is further reinforced by the fact that fractions have their own notational representation, distinct from the base-ten place value of whole numbers. The operations on numbers likewise have conceptual models, but notational representations of number are needed in order to construct *computational algorithms*. To calculate, say, a sum of two numbers is not to ask about what the sum *means*. Instead, given two numbers A and B in notation system S, a calculation is a construction of a representation of $A + B$ in same notation system S. That is why ‘ $2 + 11$ ’, though a logically correct answer to ‘What is ‘ $5 + 8$ ’’, is *not* the correct answer, 13, to the question: ‘*calculate* $5 + 8$ ’. At the same time, important as the notation is, its emphasis without links to the conceptual foundations can make it seem that quantities are the same as their number names, which is false, and potentially misleading.

Two possible pathways exist for the development of whole numbers:

Counting

Using the discrete context of finite sets, introduce whole numbers as cardinals, and addition as the cardinal of a disjoint union, and the experience of enumerating and comparing sets. (This rests on a discrete model of quantity.)

Measure

One uses the general context of *quantity of various* species of experiential objects and addition as disjoint union or concatenation (composition and decomposition). This allows discussion of comparison of quantities (‘which one is more?’), and implicitly that the larger quantity *equals* the smaller plus some complementary quantity. This can be done before any numerical values have been attached to the quantities, with the relations expressed symbolically.

Then number is introduced by choice of a unit, and the number attached to a quantity is how much of the unit is needed to constitute the given quantity. Whole numbers then are represented in the form of quantities that are measured exactly by a set of copies of the unit.

The measure pathway was articulated in detail by Davydov (1975). My first purpose here is to discuss the measure pathway and cite some possible virtues that merit our attention. In particular, I will note that it makes available from the beginning the *continuous* number line as a coherent geometric environment in which all numbers of school mathematics eventually reside.

My second purpose is to discuss our base-ten place value notation for whole numbers (and finite decimals) and their operations, emphasising its extraordinary power and its impact on the progress of mathematics and science. I will also describe a particular instructional model¹ for the introduction of place value. This model can be seen to provide an activity context for not only conceptual understanding of place value, but also one that models the ‘intellectual need’ (Harel 2003/2007) to *invent* some version of number notation based on hierarchical grouping.

19.3 Implications for the Development of the Real Number Line

19.3.1 Two Narratives

I propose here some affordances of developing number in the measure context. Most importantly, this approach offers a productive context for developing the real number line across the grades. Relying exclusively on the discrete model of counting leads to what I will call the ‘construction narrative’ of the number line, in which the new kinds of numbers, their notations and their operations are added incrementally without sufficient interconnection. In this narrative, whole numbers and their verbal names and symbolic base-ten representations predominate. New kinds of numbers are added – fractions, negative numbers, a few irrational numbers and eventually infinite decimals. This process of bringing in these new types of number can lead to ‘immigration stress’ and difficulties of assimilation of the new numbers into one coherent context. In particular, the real number line as a coherent connected number universe with uniformly smooth arithmetic operations is not as explicit as it could be.

In the ‘measure narrative’, the number line, at least as a geometric continuum, is featured as the environment of linear measurement. A premise of this trajectory is that the mathematical resources that children bring include not only discrete counting, but also a sense of measurement of continuous quantity. A possible metaphor for geometric number line is an (indefinitely long) string, flexible but inelastic. Then linear quantities would be ‘measured’ by a segment of string. This would permit comparison of size even before such measures acquire numerical names. An example of an activity drawing on this metaphor is to engage students in considering how

¹This is based on work by Deborah Ball with teacher candidates, representing work done with primary grade children.

far two toy cars travel from a starting point by examining where each car stops along a strip of tape on the floor. In order to compare measures of two things that are remote, one adopts a standard *unit* of measure, against which both quantities can be compared. And then whole number quantities appear as iterated composites of that unit.

To situate numbers on the number line, the '*oriented unit*' is specified on the geometric line by the choice of an ordered pair of points, called 0 and 1, the unit of linear measure then being the segment, $[0, 1]$, between them. The direction from 0 to 1 then also specifies a positive orientation to the number line (which has an intrinsic linear order defined by the fact that, given any three points, one lies in the interval between the other two), whereupon the whole numbers (and eventually all real numbers) can be located on the number line by juxtaposing replicas of $[0, 1]$ in the positive direction.

Of course the counting approach to whole numbers can be interpreted in measure terms, since cardinal is one particular context of measurement. However, counting is only one such (discontinuous) context, and the unit (a set with one member) must be made explicit to extend to the general concept of unit. Other units in the discrete context are made visible when one later encounters (skip) counting in groups. More general continuous measurement environments for whole numbers are robustly represented with materials such as Cuisenaire rods. Eventually, whole numbers (as cardinals) are so well conceptually assimilated that they seem to become (abstract) entities in their own right.

Fractions are often developed from a measure perspective, with fractions, from the start, being conceived as part-whole relationships, and applied to a wide variety of species of quantities: round food; lengths of ribbon; containers of sugar, or of milk; sets of objects; periods of time; etc. In contrast with whole numbers, it is less common to name a fraction without adding the word 'of'. Moreover, we do not hesitate to compare the size of whole numbers, while, with fractions, we are more prone to first ask, 'fractions of what?' – attending to specification of the unit (or whole).

19.3.2 Operations and the Real Number Line

Addition and subtraction appear to be conceptually similar in both the counting and measure regimes, addition corresponding to combination (composition and decomposition of quantities) and subtraction to taking away or comparison.

Multiplication is more subtle and more complex. One model is repeated addition of some fixed quantity, as if applying the counting regime to fixed-size groups of unit quantities. One difficulty with this model is that it obscures the commutativity of multiplication. This is sometimes repaired by use of rectangular arrays, eventually evolving into area models. The difficulty of the area model, from a measure perspective, is that numbers and their products then have different units of measure (e.g. length and area), so that it is problematic to assign meaning to an expression like $a \cdot b + c$. One resolution of this is to use a continuous version of repeated

addition, which is scaling (magnification and shrinking). This has the advantage of maintaining the species of quantities involved. These are complex conceptual issues, which I do not pursue here.

Suffice it to say here that, from the point of view of quantity (measurement), we can combine (simplify) additive expressions only when they are quantities of the same species (we do not add apples and oranges, unless combined into some larger category, like ‘fruit’), expressed with a common unit and then the sum or difference is a quantity expressed with that same unit. When dealing with fractions, a quantity like $3/5$ is understood to be three one-fifths, where the latter corresponds to a rescaling of the unit. In adding fractions, finding a ‘common denominator’ is then a process of measuring two quantities with a common unit in order to make simplification of the sum possible. Similarly, in multi-digit addition, the alignment of the base-ten representations of the summands assures that the addition in each column is adding digits with the same base-ten units attached.

On the other hand, for multiplication and division, the units of measurement are not restricted but simply parallel the operation, leading to compound units, like: kilometres/hour, foot • pounds, pounds per square inch and class • hours.

Once numbers are named and denoted (in base-ten or with fraction notation), then we develop algorithms for the operations in that notational system. The power of the base-ten system is that addition, subtraction and multiplication can be performed on *any* pair of whole numbers, knowing only how to perform single-digit operations (‘basic facts’) plus how to keep track of positional notation. This puts extraordinary computational power instructionally within reach of young children, a major historical development.

Once fractions and integers have been developed, one has the rational numbers, which are densely distributed on the number line: between any two points there is a rational number. The example of irrational numbers, like $\sqrt{2}$, shows that many points remain to be named. Informal arguments of approximation can indicate how all points can eventually be specified by possibly infinite decimal representations. Moreover, informal assurance can be given that the operations extend by continuity to all real numbers, preserving the *basic rules of arithmetic*. This synthesis of the real number line sets the stage for higher mathematics, for example calculus.

19.4 The Davydov Curriculum

Davydov, a Vygotskian psychologist and educator, and his colleagues in the Soviet Union developed, in the 1960s and 1970s, a curriculum based on the measure approach (1990).

In order to develop the concept of number, the Davydov curriculum delayed the introduction of number in school instruction until late in the first grade. Early lessons concentrate on ‘pre-numerical’ material: properties of objects such as colour, shape and size and then quantities such as length, volume, area, mass and amount of

discrete objects (i.e. collections of things, but without yet using number to enumerate ‘how many’).

According to Davydov, the fundamental problem solved by the invention of number is the task of taking a given quantity (length, volume, mass, area, amount of discrete objects) and reproducing it at a different time or place. Moxhay (2008) describes the following activity that illustrates this.

On one table is a strip of paper tape. The task is to go to another table (in a different room) and cut off, from the supply of paper tape, a piece that is exactly the same length as the original one. But one is not allowed to carry the original paper strip over to the other table. In Davydov’s experiments, children sometimes just walked over to the second table and cut off a piece of paper of a random size, hoping that it would be the same length as the original one. In such cases, conditions of the task seemed to the children to make a correct solution impossible (except by luck).

Davydov and his colleagues explained that a solution might involve taking a third object, such as string, and cutting it to be just precisely the length of the paper strip and then carrying this intermediary object (the string) to the other table, where it can be used to lay off a new paper strip of the required length. In this case, the intermediary is equal in length to the object to be reproduced. The curricular approach showed children how to take a given third object, say a piece of wood, and, if it is longer than the paper strip, mark it to show the length of the paper strip. This solution was equivalent to the first one, with the children performing just a different set of operations. But if the only available intermediary object was *smaller* than the paper strip – for example, a wooden block – this was an interesting case, for then the children could learn that they could use the block as a *unit*, as an intermediary that could be placed repeatedly (each time marking the paper with a pencil) and then *counting up* how many times the unit has been laid down. The unit could then be carried to the other table (together with the number), where it would be laid down on the paper tape the number of times that is necessary to reproduce, by cutting, a paper strip of the required length. Note that, only with this last method – selection of a unit and counting how many of it are needed – that number names make an appearance.

Although this is a particular task, solved by a particular discovery on the part of the children, it is said to lead ‘genetically’ to the solution of all analogous tasks. If the children, working as a collective, grasp the meaning of the construction they have made, then they should (again, collectively, at least at first) be able to attack all analogous problems. Davydov argues that children thus recreate, in brief, the invention of number as a human tool that enables *any* quantity to be reproduced at a different place or time. It is worth noting that this task would lose its force in the discrete context of counting, in which the portability of the unit is much simpler to achieve, but therefore is also invisible and tacit.

Davydov argued that it was important for children to reflect on, become conscious of, the ideas developed through this activity. He develops this as a collective process, with the teacher guiding the children to ask one another questions like, ‘How did you do this? Why did you do this? Does your method work? Is that the best method for solving the task?’

Fig. 19.1 Exercises from Davydov's curriculum

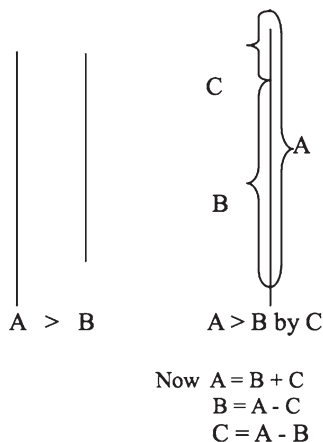

19.4.1 Algebra in the Context of Davydov

In the Davydov curriculum (see Schmittau 2005), children were to study scalar quantities such as the length, area, volume and weight of real objects, which they can experience visually and tactilely, thus gaining a first access to the real number continuum. Early in the first grade, for example, children were shown that they could make two unequal volumes equal by adding to the smaller or subtracting from the larger the difference between the original quantities. They determined that if volume A is greater than volume B, then $A = B + C$, where C is the quantity complementary to B in A. The children would be led to schematise their result with a 'length' model and symbolise it with equations and inequalities (Fig. 19.1).

The following problem, occurring approximately half-way through the first grade curriculum, provides another example of the role of the schematic in problem solving: N apples were in a bowl on the table. R people entered the room and each took an apple. How many apples remained? Children first analyse the structure of the problem, identifying it as a part-whole structure, with N as the whole and R as a part. They schematise the quantitative relations expressed in the problem as follows:



Beyond the visibly algebraic form of these equations and relations, introduced quite early, there are further noteworthy features, having to do with the very nature of the '=' sign. When equations are introduced numerically, the first exercises often have the format $8 + 4 = _$, with the result that students gain the habit of reading '='

as ‘calculate what is on the left, and put the answer on the right’. Thus, they will validate the equation $8 + 4 = 12$, but question the truth of $12 = 8 + 4$. Moreover, they may fill the blank in $8 + 4 = _ + 7$ with 12. I expect that these common confusions would be mitigated with the balancing of the quantities approach of the Davydov curriculum. Of course, other curricula have ways of accomplishing this as well.

19.4.2 Place Value

The greatest calamity in the history of science was the failure of Archimedes to invent positional notation. Carl Friedrich Gauss (as quoted by Bell 1937, p. 256)

Davydov emphasised the notion of quantity as being primary, the concept of number being later derived as a measure of one quantity by another (the unit). There then arises the task of providing names and notations for numbers. Although the notion of quantity is in some sense cognitively primordial, the naming of numbers, in contrast, is a cultural construct, and it has been accomplished historically in many different ways (see, for example, ICMI Study 13 2006). But the naming of numbers is much more than a cultural convention. It is itself a piece of conceptual technology with huge bearing on the progress of science. Our current Hindu-Arabic system of (base-ten) place value notation, now universally used in science, was solidified relatively late in history. It puts within reach of even young children a quantitative power not reached even by the mathematical genius of ancient Greece. (See the above quotation from Gauss.)

Howe (2011) offers a critique of elementary curriculum in the USA, ‘Place value [...] is treated as a vocabulary issue: ones place, tens place, hundreds place. It is described procedurally rather than conceptually’. How can one produce in young children and their teachers a robust conceptual understanding of place value? I describe here a method developed by Deborah Ball, one that is now an integral part of the teacher education programme at my university. Teacher candidates experience this sequence for several purposes, among them to appreciate the structure and meaning of a numeration system, in this case, the base-ten system. This approach fits here since its design echoes the instructional approach of Davydov (1975, 1990), Brousseau (1986) and others, who like to introduce a concept using a mathematical problem context whose solution necessitates discovery of that concept.

In this case, *the problem is to collectively count a large collection*. The size of the count is sufficient to require some structural organisation for record-keeping and to make this common across the individual counters so as to be able to coherently combine the different records. It is this need that precipitates the idea of grouping, which leads to a hierarchal structure akin to place value.

The setting here is a methods class for some 25 elementary teacher interns. (The activity is a compressed approximation of what would be done with primary grade children over much longer period of time.) About half of the interns sit in a circle on

the floor with the teacher, the others observing and taking notes. On the floor, the teacher pours out a container of over 2000 wooden sticks. She first invites the interns to guess/estimate how many sticks there are. After a wide range of guesses, she asks, 'How could we find out?' and it is suggested that they count them. So the counting begins, each intern gathering individual sticks from the pile and lining them up. However, their individual collections quickly become so numerous that they feel a need to somehow consolidate. After some discussion the idea of *grouping* the sticks emerges (see, this volume, Sect. 9.2.2). Note that this arises, not as a mathematical suggestion but as a practical necessity, given the large size of the counting task. And with rubber bands that are available, they begin to form what they call 'bundles' of sticks. But then the question arises, 'How many sticks should be in a bundle?' Several choices are considered (e.g. 2, 5, 10, 25, 60). The small values are judged not to achieve enough efficiency to be worthwhile and the larger to be possibly unwieldy. It is nonetheless clear that *this is a choice to be made*; it is not mathematically forced. (This opens the space to later contemplate place value in bases other than 10.) More importantly, *this choice should be the same for each person*. Otherwise, there would be no coherent way to count the amalgamated collections at the end. The teacher eventually encourages as consensus making bundles of ten sticks each.

Then the counting continues, and the interns make a bundle as soon as ten loose sticks are available to do so. At any given moment, an intern's collection has the form of a certain number of bundles, together with at most nine loose sticks. However, the big pile is so numerous that the interns confront the same problem again, this time with their bundles instead of individual sticks. A discussion similar to the earlier one then ensues about grouping the bundles, to form 'bundles of bundles', or 'super-bundles', as they came to be called. Again the question arose: 'how many bundles should there be in a super-bundle?' It was noted that this choice could, in principle, be independent of the first. But it was decided that there would be some mathematical merit in again choosing ten for the number of bundles in a super-bundle. And these could again be bound together with rubber bands. At this point, each intern's collection consists of a modest number of super-bundles, at most nine bundles and at most nine loose sticks.

Finally, when the big pile was exhausted, the collections of the different interns were brought together. Then the many loose sticks were bundled until at most nine loose sticks remained. In turn, then, the bundles were super-bundled until at most nine bundles remained. Finally, there being over 20 super-bundles, it was decided to make 2 'mega-bundles', each composed of 10 super-bundles. In the end, then, the original pile had been organised into two mega-bundles, four super-bundles, seven bundles and six loose sticks. Thus, the cardinal of this huge collection of could be specified by a list of just four small numbers, (2, 4, 7, 6), specifying the numbers of mega-bundles, super-bundles, bundles and loose sticks, respectively. By construction, the number of sticks in a bundle is 10, in a super-bundle $10^2 = 100$ and in a mega-bundle, $10^3 = 1000$. Thus the very concise 'coding' (2, 4, 7, 6) tells us that the total number of sticks is $2000 + 400 + 70 + 6 = 2476$ (in base-ten notation) (Fig. 19.2).



Fig. 19.2 Making bundles

This activity, with modest scaffolding, *simulated the invention of the place value system of recording numbers*. Moreover, it dramatically and physically presented the compressive power of the system: four small digits suffice to specify this perceptually very large quantity. In the course of the activity, the teacher could pose a number of questions, about representing particular numbers with the sticks and their bundles and also about how to identify numbers represented by various configurations of bundled sticks, modelling the sorts of interactions that would be carried out with children.

Attention was further drawn to the fact that the bundled sticks remained an authentic representation of quantity, since they could be unbundled to reproduce the original collection. This was put in contrast with other physical representations of number, such as Dienes blocks (see this volume, Sect. 9.3.1.2) for which the ten-rod could not be decomposed into ten little cubes; rather, this would require a trade.

These physical models of base ten provide concrete models for the arithmetic operations. The correspondence with the symbolic base-ten notation can then be extended to provide concrete meaning to the algorithms for arithmetic computation.

19.5 Conclusion

I have argued that the measure-based introduction to number, as developed for example by Davydov, supports a possibly more coherent development of the real number line. Moreover, I suggest that it allows a smooth transition from whole numbers to fractions and it provides an early introduction to algebraic thinking. Finally, I have described an instructional activity, developed by Ball, that simulates the conceptual development of place value.

Acknowledgements I am greatly indebted to Deborah Ball for critical feedback and for helpful framing of the ideas and perspectives presented here, not all of which we share.

References

- Bell, E. T. (1937). *Men of mathematics*. New York: Simon & Schuster.
- Brousseau, G. (1986). Fondements et méthodes de la didactique des mathématiques. *Recherches en Didactique des Mathématiques*, 7(2), 33–115.
- Davydov, V. V. (1975). Logical and psychological problems of elementary mathematics as an academic subject. In L. P. Steffe (Ed.), *Children's capacity for learning mathematics* (pp. 55–107). Chicago: University of Chicago.
- Davydov, V. V. (1990). *Types of generalization in instruction: Logical and psychological problems in the structuring of school curricula, Soviet studies in mathematics education* (vol. 2, pp. 1–223). Reston: National Council of Teachers of Mathematics. (Original published in 1972.)
- Harel, G. (2003/2007). The DNR system as a conceptual framework for curriculum development and instruction. In R. Lesh, E. Hamilton, & J. Kaput (Eds.), *Foundations for the future of mathematics education* (pp. 263–280). New York: Lawrence Erlbaum Associates.
- Howe, R. (2011). The greatest calamity in the history of science. Editorial, *ICMI Newsletter 18* (Ed. J. C. de Silva).
- Leung, F.K.S., Graf, K.D., & Lopez-Real, F.J. (Eds.). (2006). *Mathematics education in different cultural traditions: A comparative study of East Asia and the West: The 13th ICMI Study*. New York: Springer.
- Moxhay, P. (2008). *Assessing the scientific concept of number in primary school children*. Paper presented at ISCAR 2008, San Diego.
- Schmittau, J. (2005). The development of algebraic thinking: A Vygotskian perspective. *ZDM Mathematics Education*, 37(1), 16–22.

Open Access This chapter is licensed under the terms of the Creative Commons Attribution 4.0 International License (<http://creativecommons.org/licenses/by/4.0/>), which permits use, sharing, adaptation, distribution and reproduction in any medium or format, as long as you give appropriate credit to the original author(s) and the source, provide a link to the Creative Commons license and indicate if changes were made.

The images or other third party material in this chapter are included in the chapter's Creative Commons license, unless indicated otherwise in a credit line to the material. If material is not included in the chapter's Creative Commons license and your intended use is not permitted by statutory regulation or exceeds the permitted use, you will need to obtain permission directly from the copyright holder.



Chapter 20

Low Numeracy: From Brain to Education



Brian Butterworth 

20.1 Introduction

Leopold Kronecker is quoted famously as making the ontological claim that ‘God made the integers, all else is the work of man.’¹ This is not a testable hypothesis. Kronecker may or may not have been a believer in the supernatural when he made this statement. He was born a Jew but converted to Christianity a year before his death. He apparently believed that only integers and objects constructed from them actually existed. This included rational numbers but excluded the reals, π , transcendental numbers more generally, and infinities, all of which may be mathematically useful, but didn’t really exist.

If God did make the integers, how did we come to know them? This is a problem that has exercised the best philosophical minds since the time of Plato. However, if we take his apothegm more metaphorically, he may be arguing that our *knowledge* of maths depends on our *knowledge* of integers. That is, we recast his ontological claim as an epistemological one. We can go further, and recast God as evolution. That is to say, is there an evolutionary basis for our knowledge of integers? Here we need to step back from the term ‘integer’, which includes negative numbers, and restrict ourselves to positive whole numbers, the so-called ‘natural numbers’.

It is now widely acknowledged that the typical human brain is endowed by evolution with a mechanism for representing and discriminating numbers. It is important to be clear right at the outset, that when I talk about numbers I do not mean just our familiar symbols – counting words and ‘Arabic’ numerals, I include any representation of the number of items in a collection, more formally the cardinality of the set, including unnamed mental representations. Evidence comes from a variety of sources.

¹<http://www-history.mcs.st-andrews.ac.uk/Biographies/Kronecker.html>

B. Butterworth (✉)
University College London, London, UK
e-mail: b.butterworth@ucl.ac.uk

Human infants notice changes in the number of objects they can see, when other dimensions of the objects are controlled. In the first study of this kind, infants of 5–6 months noticed when successive displays of two dots were followed by a display of three dots and when successive displays of three dots were followed by a display of two dots. However, they did not notice a change from four to six dots or from six to four dots (Starkey and Cooper 1980). With larger numbers of dots, infants need a ratio of 2:1 to notice a change in the number of dots (Xu and Spelke 2000). Recently, studies have shown that infants notice the matches between the number of sounds and the number of objects on the screen (Izard et al. 2009; Jordan and Brannon 2006), suggesting that the infant's mental representation of number is relatively abstract – that is, independent of modality of presentation.

There is also evidence for individual differences in various measures of this ability, at least in older children (Geary et al. 2009; Piazza et al. 2010; Reeve et al. 2012). Twin studies suggest that differences appear to be at least partly genetic (Geary et al. 2009; Piazza et al. 2010; Reeve et al. 2012). The genetic factor is reinforced by the finding that certain kinds of genetic anomaly, such as Turner's Syndrome, affects numerical abilities, including very basic abilities such as selecting the larger of two numbers or giving the number of dots in an array, even when general cognitive ability is normal or even superior (Bruandet et al. 2004; Butterworth et al. 1999; Temple and Marriott 1998).

Another line of evidence comes from the studies of other species. Many of those in which numerical abilities have been tested show performance comparable with or significantly better than human infants. Chimpanzees are able to match the correct digit to a random display of dots up to at least ten (Matsuzawa 1985; Tomonaga and Matsuzawa 2002). Monkeys are able to select the larger numerosity of two displays even when the elements in the display are novel. Moreover, they show a very similar 'distance effect' to humans – that is, the more different the numbers, the more likely they are to select the larger correctly (Brannon and Terrace 1998). Birds have been known to be good at number tasks for 80 years or more. Numerical abilities have been demonstrated in elephants, cats, rats, salamanders and even fish (Agrillo et al. 2012).

Neuropsychological studies of patients with brain damage reveal a complex network in the brain that supports arithmetical processes. Damage to the frontal lobes affects the ability to solve novel problems, while damage to the parietal lobes, usually the left parietal lobe, affects the ability to do routine tasks or to recall previously learned facts (Cipolotti and van Harskamp 2001; see Butterworth 1999, Chap. 4 for reviews). Neuroimaging shows that the parietal lobes are activated by very simple tasks, such as selecting the larger of two numbers or the display with more dots (Dehaene et al. 2003; Pinel et al. 2001). In fact, small regions in the left and right parietal lobes (the intraparietal sulci) are specific for processing the numerosity of displays (Castelli et al. 2006). These regions are part of a brain network involving both the parietal and frontal lobes that are activated almost every time we carry out a numerical calculation, routine or novel (Andres et al. 2011). These findings link numerosity processing and arithmetical calculation in the brain. See Butterworth and Walsh (2011) for a review of the neural basis of mathematics. I will return to the

question of whether individual differences in brain structure and functioning can be linked to individual differences in arithmetical competence.

Various environmental factors can all be associated with lower mathematics attainment, including socioeconomic status and minority ethnic status, as well as gender, which should perhaps be considered a social rather than genetic factor in this context (Royer and Walles 2007). Although it is difficult to assess the role of poor or inappropriate teaching, the fact that the introduction of a detailed new national primary school strategy for numeracy in the UK had only a minor and possibly nonsignificant effect on numeracy for the group studied is indicative (Gross et al. 2009). It should also be noted that there are wide individual differences on even very simple tasks that depend relatively little on the quality of educational experience, such as comparison of the magnitude of two single-digit numbers or enumerating a small array of objects (Reigosa-Crespo et al. 2012; Wilson and Dehaene 2007).

Taken together, the evidence presented here suggests that factors specific to the domain of numbers and arithmetic make a major independent contribution to low arithmetic attainment. This is supported by findings from studies that have found low attainment in learners matched for IQ and working memory. In a longitudinal study by Geary and colleagues, tests on understanding the numerosity of sets and on estimating the position of a number on a number line were two important predictors of low achievement in mathematics, affecting some 50% of the sample, and of mathematics learning disability, affecting approximately 7% of the sample (Geary et al. 2009). In a sample of 1500 pairs of monozygotic (MZ) and 1375 pairs of dizygotic (DZ) 7-year-old twins, Kovas and colleagues found that approximately 30% of the genetic variance was specific to mathematics (Kovas et al. 2007). In another genetic study, this time of first-degree relatives of dyslexic probands, it was found that numerical abilities constituted a separate factor (Schulte-Körne et al. 2007). In fact, recent reviews have proposed that developmental dyscalculia follows from a core deficit in this domain-specific capacity (Butterworth 2005; Rubinsten and Henik 2009; Wilson and Dehaene 2007).

One obvious question arises: how do our numerical innate capacities relate to the learner's ability to acquire arithmetic?

20.2 Innate Capacities

Now it will come as no surprise to teachers of the first 3 years of school that children's numerical competence begins with whole numbers. However, recent research on the innate mechanisms available to humans (and many other species) propose two foundational 'core systems' that do not involve whole numbers. Deficiencies in these core systems – it has been argued – could contribute to low numeracy.

1. A mechanism for keeping track of the objects of attention. This is sometimes referred to as the 'object-tracking system' (OTS) and has limit of three or four objects. It is thought to underlie the phenomenon of 'subitising' – making an

accurate estimate of one to four objects without serial enumeration (Feigenson et al. 2004). It is proposed that the objects to be enumerated are held in working memory and that they constitute a representation with ‘numerical content’ (Carey 2009; Le Corre and Carey 2007).

2. A mechanism for the analogue representation of the approximate number objects in a display. This is referred to as the ‘analogue number system’ (ANS). The internal representations of different numerical magnitudes can be thought of as Gaussian distributions of activation on a ‘mental number line’. It is typically tested by tasks involving clouds of dots (or other objects), typically too numerous to enumerate exactly in the time available. One common task is to compare two clouds of dots. (Addition and subtraction tasks for which the solution is compared with a third cloud of dots are also used.) Individual differences are described in terms of a psychometric function, such as the Weber fraction, the smallest proportional difference between two clouds that can be reliably distinguished by the individual (Feigenson et al. 2004).

There has been considerable interest, indeed excitement, in many studies that show the performance on tasks designed to measure competence in the approximate number system correlates significantly with arithmetical performance in both children and adults (Barth et al. 2006; Gilmore et al. 2010; Halberda et al. 2008, 2012). But as we all know, correlation is not cause, and no plausible mechanism for the relationship has been proposed and accepted.

Now there are various problems with both core systems from the point of view of learning arithmetic. In the case of 1, there is an upper limit of 4. Now one key property of the number system is that a valid operation on its elements always yields another element in the same system. If one such operation is addition and if 3 is an element, then $3 + 3$ should yield an element in the system, but it cannot, since the limit is 4. To get round this, it has been proposed that noticing the number of objects being tracked can be linked to the number words a child hears and that they will be able to generalise – ‘bootstrap’ – from these experiences to numbers above the limit (Carey 2009; Le Corre and Carey 2007). The problem is that the object-tracking system is designed to keep track of particular objects with as much detail as is required by the task, not abstract away from them (Bays and Husain 2008).

The problem with 2 is that it deals only in approximate quantities, whereas ordinary school arithmetic deals with exact quantities, and the transition from approximations to exact whole number arithmetic is still mysterious. These problems are well known.

While we do not doubt that these systems exist in the brains of human infants and other species, we have argued that a quite different core system underlies the development of arithmetic. We and others have proposed a mechanism that can represent the ‘numerosity’ of a collection of objects, that is the number of objects exactly, not approximately, up to a limit imposed by the developing brain. In a pioneering exploration, Gelman and Gallistel called these representations ‘numerons’ and argued that learning to count is a process of learning how to map number words consistently onto numerons (Gelman and Gallistel 1978). I have argued, following

Gelman and Gallistel, that humans inherit a ‘number module’ to deal with sets and their numerosity and that some developmental weaknesses in arithmetical development can be traced to deficiencies in the module (Butterworth 1999, 2005).

We have shown that a neural network computer simulation of the number module using what we have called a ‘numerosity code’ accurately models the ‘size effect’ in addition. This is where accuracy and speed are a function of the addends – that is, the larger the addends or their sum, the longer it takes to retrieve or calculate the answer (Butterworth et al. 2001; Zorzi et al. 2005).

In the next section, I describe briefly some studies we have carried out that stress the importance of whole number competence in the subsequent development of arithmetic, using a very simple test: how quickly and accurately the child can enumerate a display of dots and say the answer.

20.3 Longitudinal Study of Arithmetical Development from Kindergarten to Grade 5

This is a study carried out in Melbourne, Australia, led by Robert Reeve and his lab. The sample comprised 159 5.5–6.5-year-olds (95 boys). The children attended one of seven independent schools in middle-class suburbs of a large Australian city and, at the beginning of the study, were halfway through their first year of formal schooling. The children were interviewed individually on seven occasions over a 6-year period as part of a larger study. On each occasion they completed a series of tests, including those reported here. The mean ages for the test times were (a) 6 years (5.5–6.5 years) kindergarten, (b) 7 years (6.5–7.5 years), (c) 8.5 years (8–9 years), (d) 9 years (8.5–9.5 years), (e) 9.5 years (9–10 years), (f) 10 years (9.5–10.5 years) and (g) 11 years (10.5–11.5 years). For full details, see Reeve et al. (2012). Here, I will focus on two aspects of the study: competence in numerosity processing as measured by the speed and accuracy of dot enumeration and age-appropriate arithmetic accuracy.

Using cluster analysis, dot enumeration competence revealed three clusters at each age, which we labelled fast (31% of the children), medium (50%) and slow (19%). These were relatively stable on retesting over the period of the study. That is, although children in each cluster improved with age, each tended to stay in the same cluster.

It turns out that the cluster established in kindergarten predicts age-appropriate arithmetic up to the age of 11 at least. I give below the results for three-digit calculations at ages 10–11 years (Table 20.1).

Our recent analyses show that from kindergarten to Year 2, the clusters are the main predictors of the strategies used in single-digit addition, with fast clusters more likely to recall answers from memory and use decomposition for sums over 10 in kindergarten, whereas the slow cluster children are only recalling the answers and decomposing in Year 2 and then less than 30% of the time.

Table 20.1 Three-digit subtraction, three-digit multiplication and three-digit division accuracy at age 10–11 years

	Dot enumeration cluster established in kindergarten					
	Slow		Medium		Fast	
	<i>M</i>	<i>SD</i>	<i>M</i>	<i>SD</i>	<i>M</i>	<i>SD</i>
Subtraction	46.67	7.38	81.25	2.90	90.65	2.58
Multiplication	60.56	6.53	85.10	2.15	87.07	3.57
Division	41.67	7.02	75.62	2.88	84.86	2.97

20.4 The Neural and Genetic Basis of Low Numeracy

This is a study of 104 monozygotic twins and 56 same-sex dizygotic twins aged 8–14 years. (Zygoty was assessed using molecular genetic methods.) For more further details, see Ranpura et al. (2013, submitted). All the twins in the study had brain scans and carried out a battery of 40 cognitive and numerical tests. Using factor analysis, we extracted four factors, with numerical processing accounting for 24% of the variance and having the highest loading. It comprised three timed arithmetic scores (addition, subtraction, multiplication), together with dot enumeration speed and the standardised WOND Numerical Operations (Wechsler 1996) score. Thus, a second factor (19% of the variance) included measures of general intelligence and working memory; a third factor (12%) included processing speed and performance IQ; while the fourth factor (9%) included tests of motor praxis and finger gnosis. Thus, the factor analysis reveals that that core number skills and arithmetic correlate well with each other and segregate from general cognitive and performance measures.

We replicated other research in finding a difference in grey matter in the brains of children with low numeracy or dyscalculia in the brain region of interest for numerosity processing (Isaacs et al. 2001). See Fig. 20.1.

We were also able to establish the heritability of both competence and grey matter density by comparing MZ with DZ twins: if the concordance between pairs of MZ twins is significantly higher than between pairs of DZ twins, this indicates a genetic factor.

1. Grey matter density is moderately heritable ($h^2 = 0.28$), but common environmental and unique environmental factors are also significant. Shared environment (c^2) is usually thought of as home background and schooling, which applies to both twins; unique environment (e^2) is thought of as factors specific to one of the twins.
2. Arithmetical competence and dot enumeration are both heritable. See Table 20.2.
3. The link between dot enumeration and both arithmetical competence and the region of interest is heritable. Using a different way of analysing the heritability data, called ‘cross-twin, cross-trait correlation’, we found that the correlation of dot enumeration with timed addition was substantially heritable, with over 50% of that correlation attributable to genetic factors ($h^2h^2r_G = 0.54$, $\rho = 0.76$, $p < 0.05$). Moreover, the links between the region of interest and dot enumeration, as well as arithmetical competence, were also heritable.

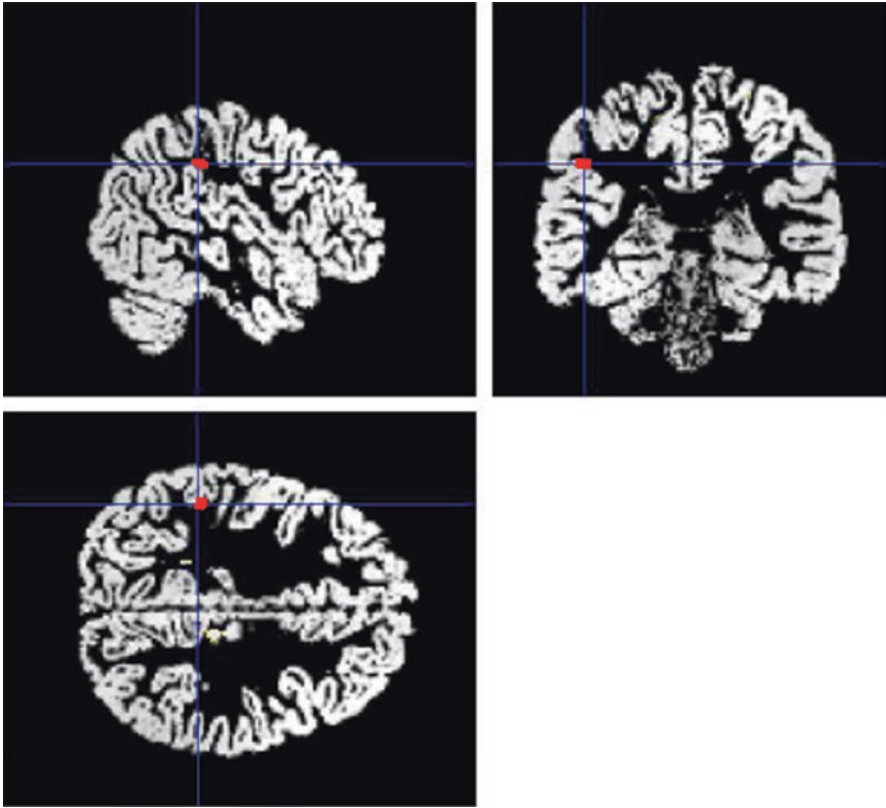

Fig. 20.1 Voxel-based morphometry (structural brain imaging) identifies a *left* parietal cluster that correlates with core number skill (35 voxels with a peak at MNI $-48, -36, 34$, pFWE-corrected <0.05)

Table 20.2 Heritability of arithmetic and dot enumeration

	h^2	c^2	e^2
	Genetic factor	Shared environment	Unique environment
Timed addition	0.54	0.28	0.17
Timed subtraction	0.44	0.38	0.18
Timed multiplication	0.55	0.31	0.15
Dot enumeration	0.47	0.15	0.38

20.5 Implications for Mathematics Education

The starting point for intervention should be a recognition that some children begin with a disadvantage and that their disadvantage lies in their capacity to deal with sets and their numerosities. This, of course, is the basis of arithmetic both from a logical and a developmental point of view. As we show here, low numeracy has a

heritable component, which confirms recent genetic studies as noted above (e.g. Kovas et al. 2007).

We can use dot enumeration in diagnostic assessments. Because these numerosity-based assessments depend much less on educational experience than tests of arithmetic, they minimise noise from instructional and motivational factors, not to mention family and environmental stressors that can also lead to low math attainment scores. Getting the correct assessment is fundamental to selecting the appropriate intervention.

Early attempts to develop new instructional interventions were based on neuroscience findings and the best practices of skilled teachers (e.g. Butterworth and Yeo 2004; Griffin et al. 1994). An important limitation of these interventions is that they required detailed instructional schemes and one-to-one teaching. It is difficult to implement these interventions in the typical math classroom, which has a whole-class age-related curriculum that makes little allowance for atypically developing children who require more attention and practice. In theory, remediation requires an approach personalised to individual learners. In practice, it is difficult to afford such instruction for even a small proportion of pupils in publicly funded education. In the UK, it has been estimated that effective intervention for 5–7-year-olds in the lowest 10th percentile, using one-to-one teaching, would cost about £2600 per learner.

The result is that many learners are still struggling with basic arithmetic in secondary school (Shalev et al. 2005). And yet effective early remediation is critical for reducing the later impact on poor numeracy skills. Although very expensive, it promises to repay 12–19 times the investment (Gross et al. 2009).

As I have argued elsewhere, one approach to the problem of delivering personalised instruction to individual learners is to make use of technology. Personalised adaptive learning technology solutions emulate the guidance of the special educational needs teacher, focusing on manipulation of numerosities (Butterworth and Yeo 2004; Räsänen et al. 2009; Wilson et al. 2006). These solutions go far beyond the educational software currently in use for numeracy teaching, which mainly targets mainstream learners. Commercial software does little more than rehearse students in what they already know, perhaps building automaticity and efficiency, but it does not foster understanding, and it does not address the numerosity processing deficit in many learners and, especially, in dyscalculics. Rarely are commercial games founded on good pedagogy.

Of course, there is no clear logical pathway from assessment to educational remedy, so our software seeks to use ideas from the best practitioners, such as Dorian Yeo (Butterworth and Yeo 2004), and established pedagogical principles, including:

1. Constructionism – construct an action to achieve goal (Harel and Papert 1991).
2. Informative feedback (Dayan and Niv 2008).
3. Concept learning through contrasting instances and generalising concepts through attention to invariant properties (Marton and Pong 2007).
4. Direct attention to salient properties (Frith 2007). This entails ensuring that everything on the screen is relevant to the task in hand.
5. The zone of proximal development – adapt each task to be just challenging enough (Vygotsky 1978).
6. Use intrinsic rather than extrinsic reinforcement (Laurillard 2012).

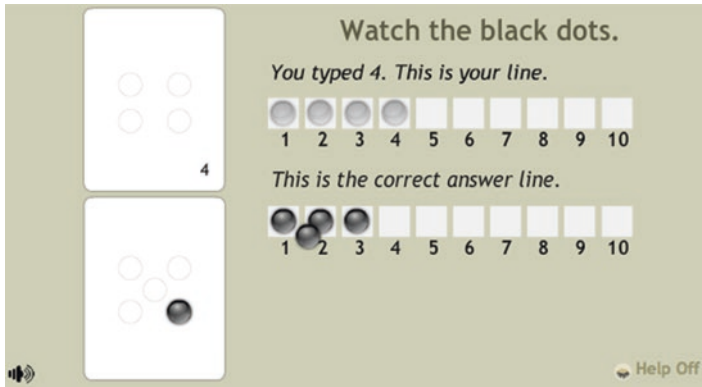

Fig. 20.2 Dots2Track (for an explanation see text)

Examples of the games following these principles have been developed by Diana Laurillard and Baajour Hassan and can be found at <http://number-sense.co.uk> (see Fig. 20.2).

Their Dots2Track game exemplifies these principles. The task is to type the number of dots in a display. At level 1, these are arranged as in dominoes. In the case of an error, learner's dots are counted onto a line above it and the correct number of dots on the line below it, exploiting principles 2 and 3. There is an opportunity to construct the correct answer by increasing or decreasing the number the learner chose (1). Everything on the screen is relevant (4), and game is adaptive, becoming more difficult depending on the accuracy and speed of the responses (5). The only reward is getting the right answer (6). There is preliminary data on the effectiveness of these games (Butterworth and Laurillard 2010).

Even if a learner has an inherited deficiency in the number module that is reflected in brain structure and functioning, this does not mean a life sentence of low numeracy. It may be that the right interventions over sufficient time can strengthen the number competence to a typical level and indeed modify the brain to a more typical structure, as has been shown in the case of phonological training for dyslexic learners (Eden et al. 2004). This will require a longitudinal study that has not yet been carried out.

20.6 Conclusions

I have argued here that the genetic research is supported by neurobehavioural research identifying the representation of numerosities – the number of objects in a set – as a *foundational capacity* in the development of arithmetic. Where this capacity is weak, education should seek to strengthen this capacity using sets of real or virtual objects and linking the sets to the spoken and written numbers until the learner can use numbers fluently and confidently. This will provide a sound basis for developing arithmetic.

References

- Agrillo, C., Piffer, L., Bisazza, A., & Butterworth, B. (2012). Evidence for two numerical systems that are similar in humans and guppies. *PloS One*, 7(2), e31923. doi:[10.1371/journal.pone.0031923](https://doi.org/10.1371/journal.pone.0031923).
- Andres, M., Pelgrims, B., Michaux, N., Olivier, E., & Pesenti, M. (2011). Role of distinct parietal areas in arithmetic: An fMRI-guided TMS study. *NeuroImage*, 54(4), 3048–3056. doi: <http://dx.doi.org/10.1016/j.neuroimage.2010.11.009>.
- Barth, H., La Mont, K., Lipton, J., Dehaene, S., Kanwisher, N., & Spelke, E. (2006). Non-symbolic arithmetic in adults and young children. *Cognition*, 98(3), 199–222.
- Bays, P. M., & Husain, M. (2008). Dynamic shifts of limited working memory resources in human vision. *Science*, 321(5890), 851–854. doi:[10.1126/science.1158023](https://doi.org/10.1126/science.1158023).
- Brannon, E. M., & Terrace, H. S. (1998). Ordering of the numerosities 1 to 9 by monkeys. *Science*, 282, 746–749.
- Bruandet, M., Molko, N., Cohen, L., & Dehaene, S. (2004). A cognitive characterization of dyscalculia in turner syndrome. *Neuropsychologia*, 42, 288–298.
- Butterworth, B. (1999). *The mathematical brain*. London: Macmillan.
- Butterworth, B. (2005). Developmental dyscalculia. In J. I. D. Campbell (Ed.), *Handbook of mathematical cognition* (pp. 455–467). Hove: Psychology Press.
- Butterworth, B., & Laurillard, D. (2010). Low numeracy and dyscalculia: Identification and intervention. *ZDM Mathematics Education*, 42(6), 527–539. doi:[10.1007/s11858-010-0267-4](https://doi.org/10.1007/s11858-010-0267-4).
- Butterworth, B., & Walsh, V. (2011). Neural basis of mathematical cognition. *Current Biology*, 21(16), R618–R621. doi:[10.1016/j.cub.2011.07.005](https://doi.org/10.1016/j.cub.2011.07.005).
- Butterworth, B., & Yeo, D. (2004). *Dyscalculia guidance*. London: nferNelson.
- Butterworth, B., Granà, A., Piazza, M., Girelli, L., Price, C., & Skuse, D. (1999). Language and the origins of number skills: Karyotypic differences in Turner's syndrome. *Brain & Language*, 69, 486–488.
- Butterworth, B., Girelli, L., Zorzi, M., & Jonckheere, A. R. (2001). Organisation of addition facts in memory. *Quarterly Journal of Experimental Psychology*, 54A, 1005–1029.
- Carey, S. (2009). Where our number concepts come from. *Journal of Philosophy*, 106(4), 220–254.
- Castelli, F., Glaser, D. E., & Butterworth, B. (2006). Discrete and analogue quantity processing in the parietal lobe: A functional MRI study. *Proceedings of the National Academy of Sciences of the United States of America*, 103(12), 4693–4698.
- Cipolotti, L., & van Harskamp, N. (2001). Disturbances of number processing and calculation. In R. S. Berndt (Ed.), *Handbook of neuropsychology* (Vol. 3, 2nd ed., pp. 305–334). Amsterdam: Elsevier Science.
- Dayan, P., & Niv, Y. (2008). Reinforcement learning: The good, the bad and the ugly. *Current Opinion in Neurobiology*, 18(2), 185–196. doi: <http://dx.doi.org/10.1016/j.conb.2008.08.003>.
- Dehaene, S., Piazza, M., Pinel, P., & Cohen, L. (2003). Three parietal circuits for number processing. *Cognitive Neuropsychology*, 20, 487–506.
- Eden, G., Jones, K., Cappell, K., Gareau, L., Wood, F., Zeffiro, T., et al. (2004). Neural changes following remediation in adult developmental dyslexia. *Neuron*, 44, 411–422.
- Feigenson, L., Dehaene, S., & Spelke, E. (2004). Core systems of number. *Trends in Cognitive Sciences*, 8(7), 307–314.
- Frith, C. D. (2007). *Making up the mind: How the brain creates our mental world*. Oxford: Blackwell Publishing.
- Geary, D. C., Bailey, D. H., Littlefield, A., Wood, P., Hoard, M. K., & Nugent, L. (2009). First-grade predictors of mathematical learning disability: A latent class trajectory analysis. *Cognitive Development*, 24, 411–429.
- Gelman, R., & Gallistel, C. R. (1978). *The child's understanding of number*. Cambridge, MA: Harvard University Press.
- Gilmore, C. K., McCarthy, S. E., & Spelke, E. S. (2010). Non-symbolic arithmetic abilities and mathematics achievement in the first year of formal schooling. *Cognition*, 115(3), 394–406.

- Griffin, S., Case, R., & Siegler, R. (1994). Rightstart: Providing the central conceptual prerequisites for first formal learning of arithmetic to students at risk for school failure. In K. McGilly (Ed.), *Classroom learning: Integrating cognitive theory and classroom practice* (pp. 25–50). Boston: MIT Press.
- Gross, J., Hudson, C., & Price, D. (2009). *The long term costs of numeracy difficulties*. London: Every Child a Chance Trust/KPMG.
- Halberda, J., Mazocco, M. M. M., & Feigenson, L. (2008). Individual differences in non-verbal number acuity correlate with maths achievement. *Nature*, *455*, 665–668. doi:[10.1038/nature07246](https://doi.org/10.1038/nature07246).
- Halberda, J., Ly, R., Wilmer, J. B., Naiman, D. Q., & Germine, L. (2012). Number sense across the lifespan as revealed by a massive internet-based sample. *Proceedings of the National Academy of Sciences*, *109*(E28), 11116–11120. doi:[10.1073/pnas.1200196109](https://doi.org/10.1073/pnas.1200196109).
- Harel, I., & Papert, S. (1991). *Constructionism: Research reports and essays, 1985–1990*. Norwood: Ablex Publishing Corporation.
- Isaacs, E. B., Edmonds, C. J., Lucas, A., & Gadian, D. G. (2001). Calculation difficulties in children of very low birthweight: A neural correlate. *Brain*, *124*, 1701–1707.
- Izard, V., Sann, C., Spelke, E. S., & Streri, A. (2009). Newborn infants perceive abstract numbers. [[10.1073/pnas.0812142106](https://doi.org/10.1073/pnas.0812142106)]. *Proceedings of the National Academy of Sciences*, *106*(25), 10382–10385.
- Jordan, K. E., & Brannon, E. M. (2006). The multisensory representation of number in infancy. *Proceedings of the National Academy of Sciences of the United States of America*, *103*(9), 3486–3489.
- Kovas, Y., Haworth, C., Dale, P., & Plomin, R. (2007). The genetic and environmental origins of learning abilities and disabilities in the early school years. *Monograph of the Society for Research in Child Development*, *72*(3), 1–144.
- Laurillard, D. (2012). *Teaching as a design science: Building pedagogical patterns for learning and technology*. New York/London: Routledge.
- Le Corre, M., & Carey, S. (2007). One, two, three, four, nothing more: An investigation of the conceptual sources of the verbal counting principles. *Cognition*, *105*(2), 395–438. doi:[10.1016/j.cognition.2006.10.005](https://doi.org/10.1016/j.cognition.2006.10.005).
- Marton, F., & Pong, W. Y. (2007). On the unit of description in phenomenography. *Higher Education Research & Development*, *24*(4), 335–348.
- Matsuzawa, T. (1985). Use of numbers by a chimpanzee. *Nature*, *315*, 57–59.
- Piazza, M., Facoetti, A., Trussardi, A. N., Berteletti, I., Conte, S., Lucangeli, D., et al. (2010). Developmental trajectory of number acuity reveals a severe impairment in developmental dyscalculia. *Cognition*, *116*(1), 33–41.
- Pinel, P., Dehaene, S., Rivière, D., & Le Bihan, D. (2001). Modulation of parietal activation by semantic distance in a number comparison task. *NeuroImage*, *14*, 1013–1026.
- Ranpura, A., Isaacs, E., Edmonds, C., Rogers, M., Lanigan, J., Singhal, A., ... Butterworth, B. (2013). Developmental trajectories of grey and white matter in dyscalculia. *Trends in Neuroscience and Education*, *2*(2), 56–64. doi: <http://dx.doi.org/10.1016/j.tine.2013.06.007>.
- Ranpura, A., Isaacs, E. B., Edmonds, C., Rogers, M., Lanigan, J., Singhal, A., ..., Butterworth, B. (submitted). *The neural and genetic basis of low numeracy*.
- Räsänen, P., Salminen, J., Wilson, A., Aunio, P., & Dehaene, S. (2009). Computer-assisted intervention for children with low numeracy skills. *Cognitive Development*, *24*, 450–472.
- Reeve, R., Reynolds, F., Humberstone, J., & Butterworth, B. (2012). Stability and change in markers of core numerical competencies. *Journal of Experimental Psychology: General*, *141*(4), 649–666. doi:[10.1037/a0027520](https://doi.org/10.1037/a0027520).
- Reigosa-Crespo, V., Valdes-Sosa, M., Butterworth, B., Estevez, N., Rodriguez, M., Santos, E., ... Lage, A. (2012). Basic numerical capacities and prevalence of developmental dyscalculia: The Havana survey. *Developmental Psychology*, *48*(1), 123–135. doi: [10.1037/a0025356](https://doi.org/10.1037/a0025356).
- Royer, J. M., & Walles, R. (2007). Influences of gender, ethnicity, and motivation on mathematical performance. In D. B. Berch & M. M. M. Mazocco (Eds.), *Why is math so hard for some chil-*

- dren? The nature and origins of mathematical learning difficulties and disabilities*. Baltimore: Paul H. Brookes Publishing.
- Rubinsten, O., & Henik, A. (2009). Developmental dyscalculia: Heterogeneity might not mean different mechanisms. *Trends in Cognitive Sciences*, *13*(2), 92–99.
- Schulte-Körne, G., Ziegler, A., Deimel, W., Schumacher, J., Plume, E., Bachmann, C., et al. (2007). Interrelationship and familiarity of dyslexia-related quantitative measures. *Annals of Human Genetics*, *71*(2), 160–175.
- Shalev, R. S., Manor, O., & Gross-Tsur, V. (2005). Developmental dyscalculia: A prospective six-year follow up. *Developmental Medicine and Child Psychology*, *47*(2), 121–125.
- Starkey, P., & Cooper, R. G., Jr. (1980). Perception of numbers by human infants. *Science*, *210*, 1033–1035.
- Temple, C. M., & Marriott, A. J. (1998). Arithmetical ability and disability in Turner's syndrome: A cognitive neuropsychological analysis. *Developmental Neuropsychology*, *14*, 47–67.
- Tomonaga, M., & Matsuzawa, T. (2002). Enumeration of briefly presented items by the chimpanzee (Pan troglodytes) and humans (Homo sapiens). *Animal Learning and Behavior*, *30*, 143–157.
- Vygotsky, L. S. (1978). *Mind in society: The development of higher psychological processes*. Cambridge, MA: Harvard University Press.
- Wechsler, D. (1996). *Wechsler objective numerical dimensions (WOND)*. London: The Psychological Corporation.
- Wilson, A., Dehaene, S., & Joliot, F. (2007). Number sense and developmental dyscalculia. In D. Coch, G. Dawson, & K. W. Fischer (Eds.), *Human behavior, learning and the developing brain: Atypical development* (pp. 212–238). New York: The Guilford Press.
- Wilson, A., Revkin, S., Cohen, D., Cohen, L., & Dehaene, S. (2006). An open trial assessment of “the number race”, an adaptive computer game for remediation of dyscalculia. *Behavioral and Brain Functions*, *2*(20). doi:10.1186/1744-9081-2-20.
- Xu, F., & Spelke, E. (2000). Large number discrimination in 6-month-old infants. *Cognition*, *74*, B1–B11.
- Zorzi, M., Stoianov, I., & Umiltà, C. (2005). Computational modelling of numerical cognition. In J. I. D. Campbell (Ed.), *Handbook of mathematical cognition* (pp. 67–84). Hove: Psychology Press.

Open Access This chapter is licensed under the terms of the Creative Commons Attribution 4.0 International License (<http://creativecommons.org/licenses/by/4.0/>), which permits use, sharing, adaptation, distribution and reproduction in any medium or format, as long as you give appropriate credit to the original author(s) and the source, provide a link to the Creative Commons license and indicate if changes were made.

The images or other third party material in this chapter are included in the chapter's Creative Commons license, unless indicated otherwise in a credit line to the material. If material is not included in the chapter's Creative Commons license and your intended use is not permitted by statutory regulation or exceeds the permitted use, you will need to obtain permission directly from the copyright holder.



Appendices

Appendix 1: The 23rd ICMI Study at the University of Macau and the Capacity and Network Projects (CANP)

Yuriko Yamamoto Baldin
Universidade Federal de São Carlos, Brazil
e-mail: yuriko.baldin@uol.com.br

Veronica Sarungi
Institute for Educational Development
The Aga Khan University, Tanzania
e-mail: veronica.sarungi@aku.edu

Introduction

The 23rd ICMI Study at the University of Macau was not only the first ICMI Study that focused on primary mathematics but was also the first such study to bring together representatives from the Capacity and Network Projects (CANPs), an initiative of ICMI that focuses on developing countries. By June 2015, when the ICMI Study was held in Macao, there had been four CANPs and a fifth was being prepared. This document presents the experience of the various CANP representatives, observers and one of the coordinators during the ICMI Study at the University of Macau as well as the impact after the meeting. The first part presents the views of representatives and observers, while the second part is a description of how the 23rd ICMI Study influenced CANP5 in 2016 as described by the general coordinator and chair of the IPC.

Strengthening and Linking CANPs

Representatives of each CANP were invited, but due to problems with visa, the CANP1 representative could not attend and so finally only members of CANP2, CANP3, CANP4 and CANP5 participated in the study thanks to the generous support of the University of Macau and ICMI. The CANP representatives were each assigned to a working group of their choice thus ensuring that other participants had an opportunity to interact and learn about the countries and regions represented by the CANP observers. Moreover, in smaller informal meetings, the CANP representatives also networked with each other and had an opportunity to have a formal meeting with Prof. Ferdinando Arzarello (president of ICMI) during which for the first time experiences across CANPs were shared. Hence, one of the major contributions of the 23rd ICMI Study was to enable the CANPs to build networks beyond their regions. As a result of connections formed in Macao, a discussion group proposal was submitted and accepted for ICME-13 that will focus on CANPs. Apart from networking, the meeting in Macao enhanced the individual capacity of the representatives that had an effect on their respective institutions, national and regional associations.

CANP2

Zumbado Castro Marianela, Costa Rica

‘The ICMI Study 23 allowed the positioning of the historical moment in which the Costa Rican Educative Reform is located, in relation to the worldwide job that is being done in the area of Numbers. It also allowed to catch a glimpse about the differences in the way of approaching and analysing this topic in different continents. The representatives of the different CANP, thanks to the auspice of the University of Macau, had the opportunity to share learning and experiences about Whole Numbers and the advances in each one of the networks; it was a unique and invaluable experience to strengthen the Worldwide Mathematical Education on the topic.’

CANP3

Mongkolsery Lin, Cambodia

‘Attending ICMI Study 23 is a professionally rewarding experience. It gave me a chance to meet and discuss with many well-known people in the field of mathematics education and also some other CANP representatives. I gained a lot of new ideas from them, not only the knowledge from the group that I attended but also the way of the workshop organised. I learnt that each member in the group had shared their

useful experiences related to the topic sessions. I had shared these ideas with my colleagues in Cambodia after return from the conference. We found that some methods are really applicable to the secondary school mathematics in Cambodia. Finally, I have to thank the University of Macau that supported me to attend in this great event.'

CANP4

Veronica Sarungi, Tanzania

'The resources on the website of the University of Macau were shared with members of the working committee of the East African Mathematics Education and Research Network (EAMERN) in their meeting in October. Members of the committee represented various universities and teacher education programmes from the four East African countries of Kenya, Uganda, Tanzania and Rwanda. In addition, the techniques and resources gained during the sessions were used in individual work done with in-service lower primary teachers since promoting early years numeracy is a focus both in Tanzania and in the region.'

CANP5

Vallejo Vargas Estela, Peru

'ICMI Study 23 gave me insight on how productive discussions might lead to interesting, valuable products. Observing the kind of work developed in an ICMI Study helped me understand that discussions are important, and moreover it is crucial to lead these discussions towards specific relevant goals which must have been previously set in order not to wander but focus. This point is what I had in mind when participated in CANP 5. Likewise, I'm sure ICMI Studies (in particular ICMI Study 23) publications can be well used for the professional development of pre-service and in-service teachers, which is directly related to CANP 5 goal, after translating them into Spanish. It was a nice experience to participate in the ICMI Study 23 and the CANP's observers meeting since I could look at the interest of the ICMI representatives in particular, and the mathematics education community in general, on the search for helping developing countries make progress on the teaching and learning of mathematics.'

Other Observers from Mekong Area

There were three (3) additional observers from Cambodia, Lao and Thailand that were countries that formed part of the Third Capacity and Network Project (CANP3). They were supported by the Centre for Research in Mathematics Education and Faculty of Education, Khon Kaen University, Thailand.

The three CANP3 observers took video recordings of various sessions both plenary and in the working group. Apart from meeting with scholars in mathematics and mathematics education, ICMI Study 23 provided an opportunity for each of the observers to learn more about and with participants from other regions. The ICMI Study 23 also provided an opportunity for various CANP representatives to meet and have a round table discussion about their networks and activities. The following are the personal reflections of each of the three observers.

Visa Kim (Cambodia)

‘At the ICMI Study 23 in the University of Macau on 6th June 2015 during a special meeting, I learned much more about the Capacity and Networking Project (CANP). I met with each CANP representative who reported on what has been done since the CANP meeting in their region such as the output of workshops, issues in the network and a vision for future and plans for follow-up activities. During the meeting, Prof. Mongkolsery mentioned about the next follow-up activity for CANP3 members in November 2015 in Thailand. I am profoundly grateful for the opportunity to be a part of the CANP and to join the ICMI Study 23’.

Chanpheng Phommaphasouk (Laos PDR)

‘I’m working at Khangkhai Teacher Training College, Pek District, Xiengkhouang Province, Laos PDR. This was my first time to participate in an ICMI Study conference. I was a representative from Laos PDR and part of the “the Great Mekong Region” group. I learnt from scholars from different countries shared experiences and knowledge of outstanding experts in mathematics education in primary education including future topics for research. Throughout the conference, I participated in many sessions and also listened to lectures from mathematicians, mathematics educators that were all useful for me. During the brief round table discussion of all CANP observers, participants from Asia, Africa and Latin America shared experience of cooperating in each region and also the President of ICMI Professor Ferdinando Arzarello suggested how to continue collaboration in each region.’

Weerasuk Kanauan (Thailand)

‘I am a doctoral student from Thailand. I got the opportunity to participate in the ICMI Study 23 Conference at the University of Macau as an observer and CANP representative. I am proud to have met with scholars whose names and works I had previously encountered in seminars and academic reading. I learned about the research in mathematics education from several countries and also shared experience about ways to enhance mathematics education with members from other

CANP regions. The conference has inspired me to work in the field of Mathematics Education and I hope to join similar studies in the future.'

The Influence of 'ICMI STUDY 23': Whole Number Arithmetic on the Activities of CANP5 in Peru

The following is presented in the words of Yuriko Yamamoto Baldin (chair of IPC, general coordinator of CANP5) who wrote this section. 'I acted as the chair of The International Program Committee of the CANP5 held in Lima, Peru, from 01 to 12 February 12, 2016. The event has brought together mathematicians, mathematics educators and representatives of the Ministry of Education from Bolivia, Ecuador, Paraguay and Peru, with the general objective of improving the quality of mathematics education in the region and aiming at the constitution of a network of collaborators to get through this objective.

Among the leading themes selected for discussion works of the CANP5, the issue of teacher education - initial and continued has had the main focus, for it raises the attention of all the participants for the implication to other themes. The national reports elaborated and presented by the country delegations to support the discussions were right on the education of teachers, in which the needs of discussing the important segment of the primary education, especially about the arithmetic literacy, were appointed as a concern of the countries in that region.

I participated in the ICMI Study 23 Conference as a contributor to the Working Group 5 with an article about a professional development course in Brazil at primary level, with focus on the arithmetic of whole numbers. Therefore, participating in the Study 23, sharing the experiences and the knowledge of the outstanding experts in the mathematics education in primary education was a real privilege that helped me to execute the scientific program of CANP5 with deeper perspectives. The generosity of the University of Macau has supported the participation of the CANP observers from CANP 2 to 5 in the works of the conference as well as in a special CANP meeting coordinated by the president of ICMI, Professor Ferdinando Arzarello. I am quite sure that this experience was definitive for the CANP 2, 3 and 4 representatives to consolidate the works in their networks, and surely to the representative of CANP5 to make her contribution during the CANP5 the most profitable and meaningful.

Since one of the objectives of the CANP5 constituted in the developments of adequate teaching materials to support the teacher education of elementary level, I am confident that the freshly constituted network of CANP5 will benefit from the ICMI STUDY 23 right for its moves in the near future. I express my gratitude to the coordinators of ICMI Study 23, Maria G. Bartolini-Bussi and Xu Hua Sun, for their reporting the Study in ICME13 with mentions to the CANP activities, so giving visibility to the networking efforts of developing countries on their way to improve the mathematics education from early years.'

Conclusion

To conclude, CANP representatives and observers have their gratitude for being invited and supported to attend the ICMI Study 23 at the University of Macau that provided them with an intellectually enriching and inspiring experience that would have a far-reaching effect. Hopefully, the interaction of CANP representatives has also enriched this unique ICMI Study just as it has had a positive impact on CANP5, which took place after the meeting in Macao. In summary, through the generosity of the University of Macau, the Education and Youth Affairs Bureau, Macao SAR and ICMI, the 23rd ICMI Study expanded what was started in individual CANPs, namely, to enhance capacity and promote networks with the ultimate goal of improving mathematics education.

Appendix 2: The Twenty-Third ICMI Study: Primary Mathematics Study on Whole Numbers (Discussion Document)

The International Program Committee of ICMI STUDY 23

Introduction and Rationale for ICMI Study 23

This document announces a new study to be conducted by the International Commission on Mathematical Instruction. This study, the twenty-third led by ICMI, addresses for the first time mathematics teaching and learning in primary school (and pre-school as well) for all, taking into account inclusive international perspectives including socio-cultural diversity and institutional constraints. One of the challenges of designing the first ICMI primary school study is the complex nature of primary mathematics. For this reason a specific focus has been chosen, as the key and driving feature, with a number of questions connected to it. The broad areas of whole number arithmetic (WNA), including operations and relations and the solution of arithmetic word problems are the kernel or core content of all primary mathematics curricula. The study of this key core content area is often regarded as foundational for later mathematics learning. However, the principles and main goals of instruction in the foundational concepts and skills in these aspects are far from universally agreed upon, and practice varies substantially from country to country. An ICMI Study that provides a meta-level analysis and synthesis of what is known about this core area of primary mathematics would provide a useful base from which to gauge gaps and silences and an opportunity to learn from the practice of different countries and contexts.

Whole numbers are part of in everyday language in each culture, but there are different views on the most appropriate age at which to introduce whole numbers in school. Whole numbers, in some countries, are approached already in pre-school, with nearly all the children before the age of six attending pre-school. The OECD has reported that, in general, participation in pre-school produces better learning outcomes for 15-year-old students (OECD PISA FOCUS 2011). In some countries, primary school includes Grades 1–6; in others it includes Grades 1–5. Also the entrance age of students for primary school may vary from country to country. For all these reasons, this study addresses teaching and learning whole numbers from the early grades, i.e. the periods in which whole numbers are systematically approached in the formal school, hence, when it is the case, also in pre-school.

In Berlin in January 2014, the International Program Committee (IPC) for ICMI Study 23 met and agreed upon four principles.

First, it was decided that **cultural diversity** and how this diversity impinges on the early introduction of whole numbers would be one major focus. The study will seek contributions from authors from as many countries as possible, especially those in which cultural characteristics are less known and yet they influence what is taught and learned. In order to foster the understanding of the different contexts where authors have developed their studies, each applicant for the Conference will be required to prepare background information (on a specific form) about this context.

Second, it was decided to find better ways to involve **policy makers** (who have the duty to offer to every child the opportunity to go to school and to learn arithmetic) and, in order to take care of this specific aim, to solicit also contributions in the form of commented and annotated video clips about practical examples with a (potentially) strong impact.

Third, it was decided to collect experiences about teaching and learning **for all**, including students with special needs, considering that in some countries they have special classrooms and teachers and even special schools, while in others they are enrolled in mainstream classes.

Fourth, it was decided to focus also on **teacher education and professional development**, considering that in order to teach elementary mathematics, there is a need for sound professional knowledge, both in mathematics and in pedagogy.

In order to meet this complex set of principles, the IPC delineated a set of **themes** to serve as the organising framework for the Study Conference.

This Discussion Document presents the background of the study, together with its challenges and aims. These sections lead to the description of the five organising themes of the study. Because the Study Conference will be organised around discussion within each theme (with some overarching sessions), each proposed contribution to the study should be addressed to the theme into which it will fit best (with a first and a second choice, according to possible multiple foci). Finally, the Discussion Document outlines the organisation, timing and location of the Study Conference and the timetable of the milestones leading up to the Conference and to ICMI publication.

Background of the Study

Primary schooling is compulsory in all countries, although with different facilities and opportunities for children to take advantage of it. Mathematics is a central feature of all primary education and the content and quality delivery of that curriculum is important in all countries for the kinds of citizens each seeks to produce.

In the international literature, there are many contributions on primary school mathematics. In many cases, especially in the West, early processes of mathematical thinking, usually observed in early childhood (i.e. 3–8-year-old children), are also investigated by cognitive and developmental psychologists, who sometimes study the emergence of these processes in laboratory settings, where children are stimulated by suitable displays (to observe the emergence of one-to-one correspondences, counting, measuring and so on). In several countries, Piaget's theory is very influential despite its critics. Also neuroscientists have been studying for some years the emergence of 'number sense', but it has been observed (UNESCO 2013) that what is still missing is a serious and deep interdisciplinary work with experts in mathematics education.

Key Challenges for ICMI Study 23

A recent document prepared by ICMI's Past President Michèle Artigue and commissioned by UNESCO (2012) discusses, from a political perspective, the main challenges in basic mathematics education. It reads:

We live in a world profoundly shaped by science and technology. Scientific and technological development has never been faster, has never had an impact as important and as immediate on our societies, whatever their level of development. The major challenges that the world has to face today, health, environment, energy, development, are both scientific and human challenges. In order to take up these challenges, the world needs scientists able to imagine futures that we barely see and able to make these possible, but it also needs that the understanding of these challenges, the debate on the proposed changes, are not reserved for a necessarily limited scientific elite, but are very widely shared. Nobody can now doubt that positive, sustainable and equitable evolutions cannot be achieved without the support and contribution of the great majority of the population. Nobody should thus doubt that the gamble of shared intelligence, that of quality education for all, and especially science education for all, including mathematics and technology education, are the only gambles we can take. This is even more the case in the current context of crisis. Without such an education, it is futile to speak of debate and citizens' participation.

Drawing on these ideas, ICMI has acknowledged that it is timely to launch, for the first time in its history, an international study that especially focuses on early mathematics education, that is, both basic and fundamental mathematically. Primary school mathematics education has been present in other ICMI Studies, but, in most cases, secondary school mathematics education was predominant. When foundational processes are concerned, a strong epistemological basis is needed. This might

be the added value of ICMI involvement with respect to the analysis carried out in other fields. Such epistemological analysis was part of classical works of professional mathematicians (e.g. Klein, Smith, Freudenthal) who played a big role in the history of ICMI (ICMI 2008) and considered mathematics teaching as a whole. It is worthwhile to mention here a short text by Felix Klein in 1923, the first President of ICMI, used as an epigraph in the website on the history of ICMI (ICMI 2008).

I believe that the whole sector of mathematics teaching, from its very beginnings at elementary school right through to the most advanced level research, should be organised as an organic whole. It grew ever clearer to me that, without this general perspective, even purest scientific research would suffer, inasmuch as, by alienating itself from the various and lively cultural developments going on, it would be condemned to the dryness which afflicts a plant shut up in a cellar without sunlight.

One cannot study school mathematics teaching without focusing also on the teacher's role and responsibility. The attention towards mathematics teacher education and professional development has been a constant preoccupation of ICMI. The case of primary school and (more generally) the case of early education deserves a special attention. The complex nature of arithmetic and its foundational value for mathematics are well known by mathematicians and mathematics educators. However, primary school teachers work within systems which may or may not support a rigorous professional environment in which they are knowledgeable and respected professionals who are experts on both the mathematics and the pedagogy of what they teach. In some systems, teaching WNA may be treated as something that virtually any educated adult can do with little specific training; WNA may be viewed by some as straightforward and intuitive and involving no more than showing children how to cope with everyday life and to carry out algorithms.

There are systems where primary mathematics teachers are specialists and other where they are generalists. It is not within the aims of this study to enter deeply into the pedagogical debate about specialist vs generalist teachers in early education, as both models show advantages and disadvantages. What is important to highlight is that much is already known from research about productive ways to teach WNA, yet this knowledge cannot be enacted in systems in which teachers are not proficient in elementary mathematics and the particular pedagogical approaches. Effective teacher education may require a backdrop of a culture in which teachers are expected to be highly educated professionals.

Aims of the Study

This study aims to produce and share knowledge on the sustainable ways of realising teaching and learning WNA for all, keeping into account the large body of theory and research already existent, socio-cultural diversity and institutional constraints. In particular, the following specific aims were acknowledged by the IPC, for the early teaching and learning WNA:

- Bring together communities of international scholars representative of ICMI's diverse membership across regions and nationalities in addressing the theme of WNA for the production of a Study Volume; provide a state-of-the-art expert reference on the theme of WNA.
- Contribute to knowledge, better understanding and resolution of the challenges that WNA faces in diverse contexts; collectively represent the great variety of concerns in the field of WNA and reflect upon it.
- Facilitate multi- and interdisciplinary approaches (including cooperation with other bodies and scientific communities) to advance research and development in WNA; disseminate scholarship in mathematics education – research, methodologies, theories, finding and results, practices and curricula – in the theme of WNA.
- Pave the way towards the future by identifying and anticipating new research and development needs of WNA; be of interest and a resource to researchers, teacher educators, policy and curriculum developers and analysts and the broad range of practitioners in mathematics and education.
- Promote and assist discussion and action at the international, regional or institutional level.

The Themes of the ICMI Study 23

The ICMI Study will be organised around five themes that provide complementary perspectives on the early approach to whole numbers in mathematics teaching and learning. Contributions to the separate themes will be distinguished by the theme's specific foci and questions, although it is expected that interconnections between themes will emerge and merit attention.

The five themes are:

1. *The why and what of whole number arithmetic*
2. *Whole number thinking, learning and development*
3. *Aspects that affect whole number learning*
4. *How to teach and assess whole number arithmetic*
5. *Whole numbers and connections with other parts of mathematics*

Themes 1 and 2 address foundational aspects from the cultural-historic-epistemological perspective and from the (neuro) cognitive perspective. What is especially needed are reports about the impact that foundational aspects have on practices (both at the micro level of students and classrooms and at the macro level of curricular choices).

Themes 3 and 4 address learning and teaching, respectively, although it is quite hard, sometimes, to separate the two aspects, as it is evidenced by the fact that in some languages and cultures (e.g. Chinese, Japanese, Russian) the two words collapse into only one.

Theme 5 addresses the usefulness (or the need) to consider WNA in connection with (or as the needed basis for) the transition to other kinds of numbers (e.g. ratio-

nal numbers) or with other areas of mathematics, traditionally separated from arithmetics (e.g. algebra, geometry, modelling).

Each theme is shortly outlined and followed by exemplary questions that could be addressed in the submitted contributions. An overarching question which cuts across all the themes concerns teacher education and development:

How can each of the themes be effectively addressed in teacher education and professional development?

The Why and What of Whole Number Arithmetic

This theme will address cultural–historic–epistemological issues in WNA and their relation to traditional, present and possible future practices.

The sense of numbers is constructed through everyday experience, where culture and language play a major role; hence, ethnomathematics has paid attention to the different grammatical constructions used in everyday talk (e.g. Maori number words as actions; Aboriginal Australians' spatial approach to numbers). Ways of representing whole numbers and making simple calculations (e.g. with fingers or other body parts; with words; with tools, including mechanical and electronic calculators; with written algorithms) have enriched the meaning of whole numbers through the ages.

The base-ten system is critical for our current sophisticated understanding of WNA. The long and difficult development of place value systems is well documented in the history of mathematics (the introduction of place value in China and India, the migration to Europe through the Arabic culture, the invention of zero, the strategies for mental calculation) and indicates the need to study place value and the base-ten system deeply for understanding.

The above issues (and others) have been considered in different ways by different cultures throughout history. Beside the use of numbers in practical activities, there is evidence (in the history and in educational research) that the exploration of the properties of whole numbers, relations and operations paves the way towards the introduction, with young students too, of typical mathematical processes, such as generalising, defining, arguing, proving.

Some references may be found in the ICMI Studies 10, 13, 16, 19.

The following possible questions will help to illuminate this theme further:

- *What goals underlie the teaching and learning of WNA?*
- *Taking a mathematical perspective (as practiced by the current community of mathematicians) combined with an educational perspective, what are core mathematical ideas in paths to developing WNA?*
- *What are distinctive features concerning whole number representation and arithmetic in your culture? What is the grammar of numbers? In what ways does language or ways of representing and using numbers influence approaches to calculation or problem-solving? How do these features interact with the decimal place value system?*

- *What is the role of mathematical practices and habits of mind in teaching and learning WNA? How can teaching and learning WNA support the development of mathematical practices and habits of mind?*
- *How much the base-ten place value is emphasised in your curriculum?*
- *How much computational facility is important for later mathematics learning and learning in other areas? What about mental calculation? What about speed of calculation?*
- *How do policies and the educational environment and system support or not support a culture in which teaching WNA is seen as requiring detailed, specific professional knowledge?*
- *What were the main historic features and their origins of WNA in (ancient) west/east? What were some factors that led to such historic features? What were the effects on the development of mathematics curriculum?*
- *How does your curriculum develop understanding of the structural features of whole number arithmetic and its extensions?*

Whole Number Thinking, Learning and Development

This theme will address the relationships between cognitive and neurocognitive issues and traditional, present and possible future practices in the early teaching and learning of WNA.

The idea of number sense was in use for decades in the literature on mathematics education before entering into the cognitive and neurocognitive literature, with some similarities and differences. (Neuro)cognitive scientists have focused on children's spontaneous tendency to focus on numerosity in their environment, the development of rapid and accurate perception of small numerosities (subitising) in connection with visualisation and structuring processes, the ability to compare numerical magnitudes and the ability to locate numbers on a (mental) number line. There are models for children's informal knowledge of counting principles and informal counting strategies and their development into more formal and abstract arithmetic notions and procedures.

A recent focus concerns developmental dyscalculia, as a difficulty in mathematical performance resulting from impairment to those parts of the brain that are involved in arithmetical processing, without a concurrent impairment in general mental function.

Recent debates concern the embodied cognition thesis resulting in the evidence, shared by many researchers, that, although mathematics may be socially constructed, this construction is rooted in, and shaped by, the body and bodily experiences.

Some references may be found in OECD 2010, UNESCO 2013.

The following possible questions will help to illuminate this theme further:

- *To what extent is basic number sense inborn and to what extent is it affected by socio-cultural and educational influences? How is the relationship between*

these precursors/foundations of WNA, on the one hand, and children's whole number arithmetic development?

- *What can we learn from the (neuro)cognitive studies in WNA? Do their findings essentially confirm insights that are present (and were already present for a long time) in the mathematics education community or do they point to truly new insights and recommendations about the kind of tasks and instructional approaches children need? How to integrate different perspectives about the foundations and development of whole number arithmetic concepts and skills?*
- *What are specific effects of the structure of the individual finger counting system on mental and linguistic quantity representation and arithmetic abilities in children, and even in older learners and adults?*
- *How an embodiment framework can be used to analyse and/or design educational approaches based on suitable representations, (e.g. through the number line) or on manipulatives and modern technological devices (touchscreens)?*
- *What are appropriate ways of analysing the multimodal nature of mathematical thinking (e.g. the role of bodily motion and gesture)?*
- *What is the relationship between the embodied cognitive approach and older approaches, for example, Montessori or Piagetian, which had a strong influence of elementary school mathematics worldwide?*
- *How can the tools of the embodiment framework/analysis be integrated/combined with socio-cultural perspectives to compare/contrast approaches where embodiment is exploited or hindered?*
- *How can teachers be educated in order to exploit the (neuro)cognitive foundations for WNA?*

Aspects that Affect Whole Number Learning

This theme will address some aspects affecting learning of WNA in both positive and negative ways.

Socio-cultural aspects influence enumeration practices, algorithms and representations as well as metaphors or models (e.g. the number line). Hence students' language and culture may help or hinder the construction of WNA not only in schools but also in informal settings. On the one hand, the recourse to tools from the history of mathematics (e.g. counting sticks, different kind of abaci, reproduction of ancient mechanical calculators) may be effective to foster learning of WNA with explicit reference to the local culture. On the other hand, intentionally designed tools may address the effective learning processes evidenced in the literature (e.g. technological tools including the multitouch ones).

Low achievement in WNA is a major focus in debates at all levels, from school's practice to international studies. Literature shows that it may depend on very different aspects: context variables (e.g. marginalised students, migrant and refugee students, education in fragile democracies), institutional variables (e.g. different languages in school and out of school context), learning disabilities (dyscalculia, sensual impairment for deaf and blind students), on affect factors (e.g. self-beliefs,

anxiety, motivation, gender issues), on didactical obstacles (e.g. a too limited approach as in the case of teaching addition separate from subtraction or multiplication as a repeated addition only) and on epistemological obstacles (related to the historical process of constructing WNA by mankind).

Some references may be found in the ICMI Studies 17, 22 and, for general issues concerning the contexts, UNESCO 2010.

The following possible questions will help to illuminate this theme further:

- *What are the features of your language related to whole numbers, operations and word problems that could affect learning in a positive or negative way? How these features are mirrored in formal, informal or not formal settings?*
- *What main challenges for learning WNA are faced by marginalised students or, in general, in difficult contexts?*
- *What main challenges are faced for learning WNA by students with sensual impairments (blind and deaf)?*
- *What main challenges are faced for learning WNA by dyscalculic students?*
- *In your country, are students with special needs enrolled in mainstream classes (inclusive systems) or in special education classes? To what extent may the strategies especially developed for students with special needs be useful for all students in WNA?*
- *In your country, are there evidence that the literature on either didactical or epistemological obstacles had impact on classroom practice?*
- *Which tools (from the ancient or new technologies) are useful to enrich the classroom activity for all or to help low achievers for WNA? Are there evidence on effective use of traditional manipulatives (including the ones rooted in local cultures), virtual manipulatives, technologies (including the recently developed multitouch technologies)? Are there classroom studies on the comparison of different kinds of tools?*
- *What strategies may be implemented by teachers in relations with the above issues?*

How to Teach and Assess Whole Number Arithmetic

This theme will address general and specific approaches to teach and assess the learning of WNA. WNA appears in the standards for mathematics of every country (see <http://www.mathunion.org/icmi/other-activities/database-project/introduction/>) in specific international studies (e.g. the Learner's Perspective Study, with 16 country teams). In some countries also independent research communities have developed projects on teaching and assessing WNA, which, in some cases, are internationally acknowledged (e.g. Realistic Mathematics Education in the Netherlands, NCTM Curriculum and Evaluation Standards in the USA, Davydov's math curriculum in Russia, the theory of didactical situations in France). In the ethnomathematics trend, projects sensitive to the local cultures and traditions have been developed (e.g. in

Australia, Latin America, the USA and Canada). A specific Symposium on Elementary Mathematics Teaching (SEMT) is held every second year in Prague since 1991.

Some issues to be focused may be the following: textbooks and future teaching aids (e.g. multimedia, e-books) for WNA, tools to approach specific elements of WNA (e.g. manipulatives, technologies), specific strategies for some fields (e.g. for word problems, the Chinese tradition of problems with variation, the Singapore's model method, the extended literature on word problems and relations with real-life situation), examples of practices rooted in local culture and metacognitive aspects in national curricula (e.g. early approach to mathematical thinking processes).

In recent years, the assessment debate at the local and school level has been very much biased by the results of international studies (e.g. OECD PISA, TIMSS), which are likely to produce assessment-driven curricula. An ICMI Study on assessment was produced in the early 1990s (ICMI Study 6), but updating might be necessary for the relevance and the media wide appeal of the international studies.

Some references for this theme may be found in the proceedings of ICMI Congress and Regional Conferences <http://www.mathunion.org/icmi/Conferences/introduction/>.

The following possible questions will help to illuminate this theme further:

- *What are the consequences of policy decision-making related to WNA teaching based on evidence in comparison with policy decision-making based on opinions?*
- *How the intended curriculum is reflected in textbook and other teaching aids?*
- *What are the changes (if any) that have resulted from the use of technology to teach WNA?*
- *How completely is understanding of the place value system developed, and at what points in the/your curriculum are key features of place value explored in greater depth?*
- *How does the/your curriculum foster the transition from a counting or additive view of number to a ratio/multiplicative/measurement view of number?*
- *How do children acquire WNA concepts and procedures outside of school? How can teachers built up on the knowledge children acquire outside school?*
- *What are the approaches that have proven to be effective in your school setting to teach elements of WNA, for example, number sense, cardinality, ordering, operations (subtraction with regrouping, etc.), problem-solving, estimation, representing, mental computation, etc.?*
- *Problem-solving context: should it be realistic? Should it be authentic? Always? What is the place (if any) of traditional word problems? What is the role of (real world) context in WNA? Always necessary?*
- *How to develop positive attitudes towards mathematics while teaching WNA?*
- *How teachers promote the development of student's metacognitive strategies during the learning of WNA?*
- *What main challenges are faced by teachers when teaching and assessing WNA?*

- *What innovative assessment approaches are used to evaluate the learning outcomes of WNA? What are the changes (if any) in assessment WNA that have resulted from the media appeal of international studies like PISA or TIMSS?*

Whole Numbers and Connections with Other Parts of Mathematics

This theme will address WNA in terms of its interrelationships with the broader field of mathematics.

Some connections concern pre-algebra and algebraic thinking (e.g. looking for patterns, schemes for the solution of word problems), geometry or spatial thinking (e.g. triangular or square numbers and similar, number lines), rational numbers and measurement (e.g. Davydov's curriculum for arithmetic) and statistical literacy (e.g. mean, median and mode, interval, scale and graphical representation).

Evidence suggests that the earliest formation of WNA can support the learning of mathematics as a connected network of concepts and, vice versa, embedding WNA in the broad field of mathematics can foster a better understanding.

Some references for this theme may be found in the ICMI Studies 9,12,14 and 18.

The following possible questions will help to illuminate this theme further:

- *How can WNA teaching and learning contribute to understand other interconnected mathematical ideas and build on one another to make students view mathematics as a coherent body of knowledge?*
- *In your country, to what extent are connections between WNA and other Mathematics topics pointed out in the curriculum syllabus and textbooks, and how are they approached? i.e. WNA and measurement, WNA and elementary statistics? Pre-algebra patterns, WNA and algebra?*
- *In your system/country, are symbolic and nonsymbolic approaches to word problems compared? To what extent are connections made between base-ten arithmetic and polynomial arithmetic? To what extent are the rules of arithmetic/properties of operations used as a guide in learning manipulation of algebraic expressions?*
- *In your country/system, to what extent are connections between WNA and other mathematics topics stressed in the teachers' education programs?*
- *In what ways does the connection between WNA and specific themes in other areas of Mathematics contribute to students' understanding of these themes?*
- *What learning conditions enable students to make connections between WNA and other mathematics topics?*
- *In which ways does the practice of connecting WNA to other areas of mathematics contribute to the development of mathematical thinking?*
- *How the connection of WNA with other areas of mathematics improve communication of mathematical ideas?*
- *How can technology be used to make connections between WNA and other mathematics topics?*

- *How does the use of representations in WNA teaching and learning contribute to build connections with other mathematical areas? For example, to what extent is the number line used to exhibit the connections between WNA and arithmetic of fractions?*

The Study Conference

ICMI Study 23 is designed to enable teachers, teacher educators, researchers and policy makers around the world to share research, practices, projects descriptions and analyses. Although reports will form part of the program, substantial time will also be allocated for collective work on significant problems in the field that will eventually form part of the Study Volume.

We plan to organise the Conference around working groups on the themes and that these groups will meet in parallel during the time of the Conference. In each working group, the IPC will organise the discussion starting from the contributions, assuming that each participant has carefully read the contributions of their working group. Some special sessions of video clip presentation will be organised, to share meaningful examples of practices concerning WNA. Thus, there will be plenty of time for discussion of submitted papers, as well as possible plans for future collaborative activity.

The Conference language is English. However, native speakers and more expert participants will make every effort to ensure that every participant may take active part in the discussion.

Location and Dates

The Study Conference will take place in Macao, China, and will be hosted by the University of Macau (**June 3–7, 2015**), with opening on June 3 at 9 AM and closing on June 7 at 2 PM. Arrival day is on June 2; departure may be scheduled as from June 7 at night.

Every effort will be made to assist participants with visa applications, if needed.

Participation

As is the normal practice for ICMI Studies, participation in the Study Conference will be by invitation only for the authors of submitted contributions which were accepted. Proposed contributions will be reviewed and a selection will be made according to the quality of the work, the potential to contribute to the advancement of the Study, with explicit links to the themes contained in the Discussion Documents and the need to ensure diversity among the perspectives. The number of invited participants will be limited to approximately 100 people.

Unfortunately, an invitation to participate in the Conference does not imply financial support from the organisers, and participants should finance their own attendance at the Conference. Funds are being sought to provide partial support to enable participants from non-affluent countries to attend the Conference, but it is unlikely that more than a few such grants will be available. Further information about the access to such grants will be available soon in the ICMI Study website.

<http://www.umac.mo/fed/ICMI23/>

ICMI Study Products

The **first product** of the ICMI Study 23 is an electronic volume of Proceedings, to be made available first on the Conference website and later in the ICMI website: it will contain all the accepted papers as reviewed papers in a Conference proceedings (with ISBN number).

The **second product** of the ICMI Study 23 is a gallery of commented video clips about practices in WNA, to be hosted on the Conference website and, possibly, later, on the ICMI website.

The **third product** is the ICMI Study Volume. The volume will be informed by the papers, the video clips and the discussions at the Study Conference as well as its outcomes, but it must be appreciated by all participants that there will be no guarantee that any of the papers accepted for the Study Conference will appear in the book. The study book will be an edited volume published by Springer as part of the New ICMI Study Series. The editors and the editing process and content will be the subject of discussion among the IPC considering also the framework prepared for the Study Conference. It is expected that the organisation of the volume will follow the organisation and themes of this Discussion Document, although some changes might be introduced to exploit the impact of the discussion raised during the Conference. A report on the study and its outcomes will be presented at the 13th International Congress on Mathematical Education, to be held in Hamburg, Germany (24–31 July 2016). It is hoped that the Study Volume will also be published in 2016.

Call for Contribution to ICMI Study 23

The IPC for ICMI Study 23 invites submissions of contributions of several kinds: theoretical or cultural–historic–epistemological essays (with deep connection with classroom practice, curricula or teacher education programs), position papers discussing policy and practice issues, discussion papers related to curriculum issues, reports on empirical studies and video clips on explicit classroom or teacher education practice. To ensure a rich and varied discussion, participation from countries

with different economic capacities or with different cultural heritages and practices is encouraged.

The IPC encourages people who are not so used to such Conferences to submit earlier (see the deadlines below) in order to receive assistance for finalising their contribution (this assistance concerns the choice of the topic of the contribution and the structure of the paper, not the editing of English language). In this way the IPC inaugurates a new tradition of helping newcomers (including practitioners) to the international mathematics education community. This implies a process of supporting the writing of a contribution which the IPC judges as having the potential to contribute to the study (see below).

An invitation to the Conference does not imply that a formal presentation of the submitted contribution will be made during the Conference or that the paper will appear in the Study Volume published after the Conference.

Submissions

The ICMI Study website is opened at the address

<http://www.umac.mo/fed/ICMI23/>

The website will be regularly updated with information about the study and the Study Conference and will be used for sharing the contributions of those invited to the Conference in the form of Conference pre-proceedings.

Two kinds of submissions are welcome:

Papers prepared in English (the language of the Conference) according to a **template** (max 8 pages).

Video clips (5–8 min) with **English subtitles** with an accompanying paper prepared according to a **template** (max 6 pages) together with the author's declaration of having collected **informed consent forms** signed by the participants. The English subtitles are required also in the videos with English speakers, in order to help the understanding of the interaction for non-native speakers. Blurring faces of participants for privacy reasons, when needed, has to be made by the applicants before sending the videos.

The files are to be saved with the name

Familyname_name

Accepted file extensions are the following:

papers: .doc; .docx; .odt together with a .pdf copy.

videos: .mp4; 3gp.

In both cases, the indication of the working group – theme (1st and 2nd choice) where the paper or the video clip is expected to be discussed – must be included.

In both cases, also the **context form** has to be filled out by all the author(s) as completely as possible to help readers to understand the context of the contribution and interpret the contribution accordingly.

The template, context form, the informed consent form and the form for personal data can be downloaded from the ICMI website.

It is not allowed to submit two papers with the same first author.

Information about the technical way of submitting a paper or a video + paper will be available soon in the study website.

Deadlines

August 31, 2014: People who believe to need assistance for finalising their contribution must submit a tentative copy with an appropriate form (**assistance form**) for requiring assistance no later than August 31, 2014. Their submissions will be examined immediately. The author will receive within September 30 the information of the decision (rejected, accepted pending revision, accepted in the present form). In the second case, an IPC member will act as ‘tutor’ to help the final preparation of the paper. Then the final paper will undergo the standard review process. The assistance form can be downloaded from the study website.

September 15, 2014: Submissions by people who do not require help must be sent no later than September 15, 2014, but earlier if possible.

February 2015: Proposals will be reviewed, decisions made about invitation for the Conference in February 2015 and notification of these decisions sent within the end of February.

Information about visa, costs and details of accommodation will be available on the website

<http://www.umac.mo/fed/ICMI23/>

Further information may be asked at the following address:

e-mail: icmiStudy23@gmail.com

Members of the International Program Committee

Maria G. Bartolini Bussi	Department of Education and Human Science	University of Modena and Reggio Emilia, Italy	bartolini@unimore.it	Co-chair
Xu Hua Sun	Faculty of Education	University of Macau, China	xhsun@umac.mo	Co-chair
Berinderjeet Kaur	Centre for International Comparative Studies	National Institute for Education, Singapore	berinderjeet.kaur@nie.edu.sg	

Hamsa Venkat	Mathematics Education Unit	University of the Witwatersrand, Johannesburg, South Africa	hamsa.venkatakrisnan@wits.ac.za	
Joanne Mulligan	School of Education	Macquarie University, Sydney, Australia	joanne.mulligan@mq.edu.au	
Jarmila Novotna	Faculty of Education	Charles University, Prague, Czech Republic	jarmila.novotna@pedf.cuni.cz	
Lieven Verschaffel	Faculty of Psychology and Educational Sciences	KU Leuven University, Leuven, Belgium	lieven.verschaffel@ppw.kuleuven.be	
Maitree Inprasitha	Faculty of Education	Khon Kaen University, Thailand	inprasitha@hotmail.com	
Sybilla Beckmann	Department of Mathematics	University of Georgia, Athens, GA USA	sybilla@math.uga.edu	
Sarah Inés González de Lora Sued		Pontificia Universidad Católica Madre y Maestra, Santiago de los Caballeros, República Dominicana	sarahgonzalez@pucmmsti.edu.do	
Roger E. Howe	Department of Mathematics	Yale University, New Haven, CT USA	howe@math.yale.edu	ICMI liaison
Ferdinando Arzarello	Department of Mathematics	University of Turin, Turin, Italy	ferdinando.arzarello@unito.it	ICMI President
Abraham Arcavi	Department of Science Teaching	The Weizmann Institute of Science, Rehovot, Israel	abraham.arcavi@weizmann.ac.il	ICMI Secretary General

References (Limited to Documents from ICMI or Other International Bodies)

- ICMI Studies (list), <http://www.mathunion.org/icmi/Conferences/icmi-studies/introduction/>
- ICMI (2008). *The first century of the international commission on mathematical instruction*. History of ICMI, by Fulvia Furinghetti & Livia Giacardi, <http://www.icmihistory.unito.it> (last visited March 23, 2014)
- OECD EDUCERI (2010). *Dyscalculia primer and resource guide* by Anna J. Wilson, Retrieved from <http://www.oecd.org/edu/cei/dyscalculiaprimerandresourceguide.htm> (last visited on March 23, 2014)
- OECD PISA FOCUS (2011). *Does participation in pre-primary education translate into better learning outcomes at school?*, Retrieved from http://www.oecd-ilibrary.org/education/does-participation-in-pre-primary-education-translate-into-better-learning-outcomes-at-school_5k9h362tpvxp-en;jsessionid=eos7dj2qr9bgo.x-oecd-live-02 (last visited on March 23, 2014)

- UNESCO (2012). *Challenges in basic mathematics education*, by Michèle Artigue, retrieved from <http://unesdoc.unesco.org/images/0019/001917/191776e.pdf> (last visited March 23, 2014)
- UNESCO (2013) *Educational neuroscience: more problems than promise?* By Ilkka Tuomi, Retrieved from <http://www.unescobkk.org/resources/e-library/publications/article/educational-neurosciences-more-problems-than-promise-education-policy-research-series-discussion/> (last visited March 23, 2014)

Appendix 3: Electronic Supplementary Material

Maria G. Bartolini Bussi and Xu Hua Sun

In the Discussion Document of the ICMI Study 23, a specific request to submit video clips with English subtitles was made (this volume, Appendix 2). The rationale was twofold, as visual data *are becoming more and more important in many studies, to record not only verbal interaction and written protocols, but also gestures and gazes and may communicate better than long verbal explanation the quality of interaction, the organisation of the classroom, the speed of the process*. Hence, the video clips were introduced by a short text, in order to reconstruct or interpret the process.

The video clips shown at the Conference are collected, together with very short introductions. More details about the context are available in the volume and in the Proceedings of the Conference. The Proceedings are freely available in Sun, X., Kaur, B., & Novotna, J. (Eds.). (2015). Conference proceedings of the ICMI study 23: Primary mathematics study on whole numbers. Retrieved February 10, 2016, from www.umac.mo/fed/ICMI23/doc/Proceedings_ICMI_STUDY_23_final.pdf

All the videos have been collected according to the privacy rules of the different countries. The use of these videos is strictly personal: they can be used by mathematics educators for research purposes and cannot be shared in the internet via social media.

The complete list of video clips follows, reporting the relevant chapters below of this volume.

Chapter 7

Gould P. J. (2017). From numerals to words

Jed's oral counting sequence extends to 12 or 13. To identify numerals beyond 3 he appears to use a form of a mental number line from 1 to 10, with the location of the numerals often unclear above 5. For example, when asked to identify '6', Jed repeatedly asked if it was upside down. He then answered that 'six' was 'five'. Jed could consistently count just past ten, but he could not identify all of the numerals

from '1' to '10'. He appeared to only be able to effortlessly identify the first three numerals. For other numerals, Jed gave every indication of accessing a mental number line arrangement of numerals and counting from the location of a known value. Although Jed's method of identifying numerals is atypical of a student in the third year of school, it sheds light on the transcoding pathway from numerals to number words.

Baccaglini-Frank A. (2017a). Mental strategy for multiplication explained by grade 2 student using rectangle diagrams

In the PerContare Project, 7-year-old students learned to think about (and perform) products (up to 10×10) using *rectangle diagrams*, cardboard rectangles with a grid of 1cm^2 squares marking the dimensions, which represent the numbers to be multiplied. Physical and mental manipulation of the rectangle diagrams was explored and fostered to calculate unknown products of numbers. By the end of the school year, many children were able to perform calculations, without the support of the physical rectangle diagrams, any longer. This video is an example containing an elaborate and complete verbal description, produced by Marco (7 years 8 months), of the mental (and highly visual) strategy he uses to figure out 7×8 when he is called on by the teacher.

Chapter 9

Arzarello F. (2017). How “the Chinese dragon” helps the first grade children’s counting

An Italian teacher, Bruna Villa, has developed an effective learning design for grade 1 children to teach them how to grasp the machinery of whole numbers. She based her design on what she called the method of the ‘small Chinese dragon’, in which the children articulate numbers based on a uniform Chinese-like structure (e.g. 11 is ‘ten-one’ and not ‘undici’; 21 is two (times)- ten- one and not ‘ventuno’) before passing to the Italian system. In this way, she has been able to shorten the time needed to master the whole numbers from 1 to 100 (in Italian words and standard arithmetic representation) and to use them to conduct arithmetic.

Bartolini Bussi M. G. (2017). Some Western ways of using the number line in grade 2

The number line draws on the Euclidean tradition of representing numbers with line segments. It was transformed into a teaching aid in Europe in the seventeenth century. Now number lines are part of the everyday experience of pupils, either in games (e.g. the board game of the Goose especially popular in Southern Europe), or in everyday tools (e.g. the graded ruler or scales in measuring instruments with direct reading). The video clip shows the 2nd grade students jumping on the floor, in order to explore a big size number line. There are episodes of either low or high achievers, under the adult’s guidance.

Inprasitha M. (2017). An open approach incorporating lesson study: An innovation for teaching whole number arithmetic

Open Approach was first introduced in Thailand at the Faculty of Education, Khon Kaen University. This introduced a paradigm change in the Thai teaching from a traditional teaching approach, delivering contents from a teacher to students, to an Open Approach. This example illustrates how first grade student learned to gain an implicit understanding of whole number arithmetic via mathematical activities teaching through four steps of Open Approach incorporating in Lesson Study. A learning unit was designed within the ‘base ten and place values’ in the first grade emphasising ‘how to learn’, rather than merely content, in order to support students’ self-learning through problem-solving. The four video clips show:

Posing an open-ended problem.

Learning through problem solving.

Whole-class discussion and comparison.

Summarisation through connecting students’ mathematical ideas.

Rottmann T. (2017). Difficulties with whole number learning and respective teaching strategies: the case of Ole

The video presents some sections of the initial diagnostic interview and individual tutoring sessions with Ole (Grade 2) conducted by pre-service teachers at the ‘Counselling Centre for Dyscalculic Children’ at Bielefeld University. The intervention focuses on the development of non-counting calculation strategies for addition and subtraction tasks. The main aim of the video is to illustrate an approach to assist the development of mental images by gradually and systematically replacing the use of concrete manipulatives with mental strategies. This process of internalisation is described in terms of a Four-Phases-Model that acknowledges the need for verbal descriptions when using and replacing manipulatives and presents transitional phases from manipulating with material to mental actions and the associated mental operations.

Sarungi V. (2017). Popular Number song in Swahili. Naweza kuhesabu namba

The video clip shows a popular number song in Swahili. There is no subtitle but the transcript is attached.

How to sing	Swahili	English translation	Remarks
All of this twice ^a	Naweza kuhesabu namba	I can count numbers	
	moja, mbili, tatu	One, two, three	
All of this twice	Nne, tano, sita, saba, nane, tisa, kumi	Four, five, six, seven, eight, nine, ten	
All of this twice	Vidole vya mikono yangu	The fingers of my hand	‘vidole’ means ‘fingers’ and ‘mikono’ means ‘hands’
	Jumla yake kumi	(their) total is ten	The word ‘jumla’ means ‘total’

How to sing	Swahili	English translation	Remarks
All of this twice	Huku tano na huku tano	Here five and here five	
	Jumla yake kumi	(their) total is ten	

It is a common practice to sing 'lines' of a song twice – usually the first time it is by the teacher (or leader) and the second time by all. However, for this song, which is very popular and well known by everyone, the lines are still repeated twice even when there is no leader (i.e. whole group sings each line twice)

Chapter 11

Sun X.H. (2017a). Open class: Addition of nine and one-digit with regrouping

This example illustrates how 1st grade students learned to do addition with regrouping for the first time. The context was 'sport time'. Materials (counters) were used to represent the situation and the calculation strategies for $5 + 9 = 14$. The students worked in groups of four to discuss the possible strategies for this calculation, while the teacher moved between the groups to observe, listen to and discuss the strategies. Students were selected to come to the front of the class and explain their strategies. The teacher explored three different strategies with regrouping:

$$5 + 9 = 4 + 1 + 9 = 4 + (1 + 9) = 14.$$

$$5 + 9 = 5 + (4 + 5) = 4 + (5 + 5) = 14.$$

$$5 + 9 = (10 - 1) + 5 = (10 + 5) - 1 = 14.$$

Sun X.H. (2017b). Open class in ICMI STUDY 23 Conference: Addition of two-digit and on-digit with regrouping

This example illustrates how 1st grade students learned to do addition with regrouping. The context was 'Party time'. Materials (candies) were used to represent the situation and the calculation strategies for $24 + 9 = 33$. The students worked in groups of four to discuss the possible strategies for this calculation, while the teacher moved between the groups to observe, listen to and discuss the strategies. Students were selected to come to the front of the class and explain their strategies. The teacher explored three different strategies with regrouping:

$$23 + (1 + 9) = 33.$$

$$20 + (4 + 9) = 33.$$

$$(24 + 6) + 3 = 33.$$

Chapter 13

Ramploud, A., Mellone, M. and Munarini, R. (2017). Additive structure: An educational experience of cultural transposition

The video shows the solution of this exercise in an Italian fifth grade class:

Grandmother gives 618 euros to her grandchildren, Franca, Nicola and Stefano. Franca receives twice Nicola's amount Stefano receives 10 euros more than Nicola. How many euros will each grandchild receive?

The exercise, done in small groups, was corrected together; the various method resolutions were shown to the class. In this case, the reflection on the pictorial equation and on its meaningful use (Russian and Chinese) gave us the opportunity to explore its use in a more conscious way. Indeed, even if it is not present in the tradition of the Italian school curricula, in the presented experience, we recognise the opportunity to develop, towards arithmetic with primary pupils, an approach which pays more attention to the structural features than to the numerical ones. As a matter of fact, we observed pupils' natural and flexible recourse to algebraic language in a context built on the pictorial equation.

Chapter 15

Arzarello F. (2017). How the Chinese dragon helps first grade children's counting

(see the Chap. 9 entry)

Bartolini Bussi M. G. (2017). Some Western ways of using the number line in grade 2

(see the Chap. 9 entry)

Chapter 16

Baccaglioni-Frank A. (2017b). Strategies for multiplication using rectangle diagrams in grade 2

The teacher has asked the children to share strategies they used to figure out 8×6 , showing their procedure on the blackboard. One student breaks 8 into 5, 2 and 1, then he counts up by 5 to obtain the first piece, mentally rotates the second piece and remembers that $6 + 6 = 12$ and recognises the last piece as 1×6 . So he finally adds $30 + 12 + 6$. Another student decides to recompose 8 as $10 - 2$ and describes her reasoning through 'ghost rectangles', rectangles that appear to make the calculation easier, but then they need to be taken away. She uses ghost rectangles to think of 8 as a part of 10, to reach the product $10 \times 6 (= 60)$, and then subtract off $2 \times 6 (= 12)$.

Author Index

A

Abdulhamid, L., 412
Adler, J., 319, 351
Aebli, H., 206, 207
Agrillo, C., 478
Ainscow, M., 29
Alafaleq, M., 57, 281, 290
Albert, L., 76
Alexander, R.J., 401
Allan, K., 50
Anderson, L.W., 413
Andres, M., 478
Andrews, P., 93, 113, 147, 157
Ang, T.S., 37, 39, 44–49, 95, 96, 102, 106, 115, 193, 359
Anghileri, J., 402
Ansari, D., 160, 376, 377, 382
Arcara, G., 394
Armstrong, B., 281
Archer, S., 199
Artigue, M., 305, 332
Arzarello, F., 181–222, 343–370
Ascher, M., 106
Ascher, R., 106
Askew, M., 39, 110, 251–282, 288, 299–321, 399–431
Attridge, N., 159
Aunio, P., 157, 484
Ayer, A.J., 177
Azrou, N., 41, 91–120, 343–370

B

Baccaglioni-Frank, A., 61, 72, 73, 83, 137–163, 195, 211, 212, 375–394, 405
Bachmann, C., 479
Bagni, G., 200
Bailey, D.H., 478, 479
Bakhurst, D., 306
Bakker, M., 39, 183, 198
Baldin, Y., 199, 301
Ball, D.L., 11, 32, 183, 199, 217, 287, 319, 332, 426
Bantova, M.A., 448
Barkai, R., 405
Baroody, A.J., 144
Barros, R., 144, 309, 321
Barry, A., 253, 288
Barth, H., 480
Barth, J.T., 30
Bartolini Bussi, M.G., 3–16, 19–32, 35–65, 72, 73, 83, 140, 150, 151, 181–222, 266, 269, 280, 343–370, 380, 381, 399–431
Barton, B., 91, 95, 344, 345, 364
Barwell, R., 28, 36, 221, 344
Bass, H., 39, 55, 60, 61, 100, 181–222, 465–474
Bassok, M., 335
Bastable, V., 312
Baxter, W.T., 97
Bays, P.M., 480

- Bazzanella, C., 37, 345
 Bazzini, L., 343–370
 Beatty, R., 328
 Beck, D.M., 160
 Beckmann, S., 5, 12, 106, 299–321, 399–431
 Bednarz, N., 334
 Beeres, K., 159
 Beilock, S., 148
 Beishuizen, M., 402
 Bell, D., 144
 Bell, E.T., 472
 Beller, S., 72
 Beltyukova, G.V., 448
 Benavides-Varela, S., 394
 Bender, A., 72
 Bennett, J., 329, 335
 Berch, D.B., 376
 Berteletti, I., 393, 478
 Bertolini, C., 425
 Bevan, A., 376, 393
 Bevan, K., 263
 Bezout E., 103, 104
 Bicknell, B., 39, 150, 153, 182, 201, 220
 Bikner-Ahsbahs, A., 288
 Bill, V.L., 150
 Billig, M., 430
 Bisazza, A., 478
 Bishop, A.J., 344
 Black, P., 276
 Blomhøj, M., 314
 Blum, W., 118
 Blunk, M.L., 287
 Bobis, J., 263
 Boero, P., 352
 Bokhove, C., 13
 Booth, J.L., 144, 159
 Booth, T., 29
 Borwein, J., 188
 Bosch, M., 186, 219
 Bowden, J., 270
 Bow-Thomas, C.C., 43, 60, 144
 Brandl, M., 13
 Brannon, E.M., 346, 478
 Bratton, S.L., 29
 Briand, J., 105
 Briars, D.J., 40, 132
 Brissiaud, R., 345
 Britt, M.S., 150
 Brombacher, A., 14, 254, 296
 Brooks, E., 456, 461
 Brousseau, G., 93, 104, 272, 273, 295,
 296, 427, 472
 Brousseau, N., 295
 Brown, M., 110
 Brown, T., 118
 Bruandet, M., 478
 Bruner, J.S., 117, 206, 262
 Bruun, F., 175
 Bryant, B.R., 388
 Bryant, D.P., 388
 Bryant, P., 144, 309, 321
 Burgio, F., 394
 Burman, D., 144
 Burton, L., 327
 Butterworth, B., 60, 139–142, 157,
 160, 161, 172, 221, 346, 375–394,
 477–485
 Byerley, C., 337
- C**
 Cai, J., 43, 44, 55, 58, 174, 269, 314, 428
 Cajori, F., 56, 444
 Cao, Y., 106, 193, 280, 289
 Cappell, K., 485
 Capraro, M.M., 55, 439, 458
 Capraro, R.M., 55
 Caraballo, J., 98, 106, 190
 Carey, S., 172, 173, 480
 Carlson, M., 337
 Carney, N.A., 29
 Carragher, D.W., 176
 Carspecken, P.F., 44, 186
 Case, R., 484
 Castelli, F., 478
 Cauty, A., 98
 Chamberlain, D., 384
 Chambris, C., 91–120, 280, 403
 Chan, C.M.E., 408–410
 Chan, T.C., 31
 Chang, A., 382
 Chang, C.-M., 350
 Changsri, N., 93, 280, 281
 Channell, J., 79
 Charalambous, C.Y., 287
 Chauma, A., 42
 Chávez, O., 279
 Chee, K.S., 220
 Cheeseman, J., 262, 263
 Chemla, K., 45, 47, 95, 96, 106, 366
 Chen, L., 299–321
 Cheng, E.C.K., 418
 Cheng, Z.J., 207
 Chesnut, R.M., 29, 30
 Cheung Chan, T., 418
 Cheung, K.-C., 254, 280, 281, 289, 293
 Cheung, K.-F., 280, 281, 293
 Cheung, S.K., 301

- Cheung, W.M., 58
 Chevallard, Y., 117, 186, 219
 Chi, M., 335
 Chik, P.P.M., 270
 Chiu, M.M., 207
 Chrisomalis, S., 71–74, 84, 85
 Christie, C., 144
 Cipolotti, L., 478
 Cjik, P.P.N., 265, 269, 270
 Clark, R.E., 306, 335
 Clarke, B., 262, 263
 Clarke, D., 118, 262, 263, 301, 310, 319
 Clarkson, P., 28, 36, 221, 344
 Clayton, S., 159
 Clements, D.H., 144, 209, 383
 Clements, M.A., 264
 Clerc, P., 345
 Coban, L., 159
 Cobb, P., 263
 Cocker, E., 440, 453
 Cohen, D., 484
 Cohen, L., 140, 142, 172, 478, 484
 Colburn, W., 446
 Cole, D., 408–410
 Cole, M., 6, 185
 Coles, A., 78, 85, 137–163, 169, 170, 172, 173
 Condon, C., 199
 Conte, S., 393, 478
 Conti, A., 191
 Cooper, J., 91–120, 133, 281, 303
 Cooper, R.G. Jr., 478
 Cooper, T., 307
 Corry, L., 305
 Crevensten, N., 146, 153, 383, 384
 Croswell, M., 263
 Crump, T., 98
 Cuban, L., 422
 Cullen, C., 46
 Cuoco, A., 335, 337
- D**
 Dale, P., 479, 484
 D'Alessio, S., 29
 D'Ambrosio, U., 344, 355
 D'Amore, B., 200
 Dauben, J., 44
 Davies, C., 440, 453
 Davis, B., 325, 335, 336, 383
 Davis, J., 325–337
 Davis, R., 337
 Davydov, V.V., 170, 174, 176, 308, 313, 465, 467, 469, 472
 Day, C., 422
 Dayan, P., 484
 De Bock, D., 309
 de Corte, E., 333
 de Freitas, E., 73
 de Lora Sued, S.G., 91–120, 343–370
 De Smedt, B., 139, 144, 156, 159, 160, 376, 382
 Defever, E., 159
 Degrande, T., 159, 162
 Dehaene, S., 140, 142, 172, 346, 382, 478–480, 484
 Deimel, W., 479
 DeLoache, J.S., 188
 Dewey, J., 185, 186
 Diaz, J.M., 175
 Dienes, Z.P., 76, 199
 Ding, M., 55, 439, 458
 Dole, S., 281, 301, 310, 319
 Dong-Joong, K., 200
 Dorier, J.-L., 91–120
 Dossey, J.A., 414
 Dougherty, B.J., 170, 313
 Dowker, A., 144, 377
 Drijvers, P., 262, 305
 Driscoll, M.J., 307
 Dröge, D., 205
 du Coudray, H.E., 29
 Dumont, A.S., 30
 Dykes, V.J., 175
- E**
 Ebeling, A., 205
 Ebersbach, M., 159, 162
 Eden, G., 485
 Edmonds, C.J., 482
 Edwards, B.S., 405
 Ejersbo, L.R., 40, 91–120
 Ekdahl, A.-L., 253, 279, 295
 El Bouazzaoui, H., 104
 Elia, I., 137, 140, 148, 154
 Ellerton, N., 264
 Ellis, A.B., 309, 310
 Engeström, Y., 185, 186
 English, L.D., 146, 153, 206, 383, 384
 Ensor, P., 153, 412
 Eraky, A., 300, 307
 Erfjord I., 12
 Estevez, N., 479
 Evans, D., 144
 Even, R., 11, 32, 426
 Eves, H., 126

F

Facoetti, A., 393, 478
 Fairhall, U., 196
 Fan, L., 13, 43, 44, 57, 60, 281, 290
 Faul, M., 29
 Fauvel, J., 200, 201
 Fayol, M., 350
 Feigenson, L., 172, 480
 Feniger, Y., 114
 Fernandes, L., 105
 Ferrara, F., 300, 307, 328
 Ferreras, A., 21
 Ferri, B., 29
 Ferrini-Mundy, J., 200, 430
 Fias, W., 382
 Filipowicz, A.T., 382
 Findell, B., 335
 Fischer, M.H., 382
 Fish, D., 456, 461
 Floden, R.E., 430
 Floyd, A., 327
 Foulkes, M.A., 30
 Fowler, D.H., 76, 82
 Fraenkel, A., 170
 Freeman, D., 279
 Frege, G., 170
 Freiman, V., 13
 Freudenthal, H., 305
 Frith, C.D., 484
 Funghi, S., 40, 42
 Fuson, K.C., 40, 43, 44, 60–62, 111–113,
 132, 143, 173, 262
 Fussenegger, B., 394

G

Gadian, D.G., 482
 Gallese, V., 380
 Galligan, L., 44
 Gallistel, C.R., 173, 347, 480
 Gardner, H., 10
 Gareau, L., 485
 Gattegno, C., 78, 80, 148, 149, 170,
 173–175, 336
 Gearhart, M., 276, 279
 Geary, D.C., 14, 36, 43, 60, 144, 478, 479
 Gebuis, T., 159
 Gelderblom, G., 386
 Gelman, R., 173, 347, 480
 George, G.J., 345
 Germine, L., 480
 Gerofsky, S., 333
 Gersten, R., 388

Gervasoni, A., 150, 154, 182, 219,
 251–282, 296
 Ghesquière, P., 139, 144, 156
 Gilmore, C.K., 144, 159, 376, 382, 480
 Girelli, L., 478, 481
 Glaser, D.E., 478
 Glutting, J., 157
 Göbel, S.M., 143
 Goh, S.P., 411
 Goldenberg, P., 335, 337
 Goldstein, B., 29
 Golinkoff, R.M., 382
 Gollop, M., 220
 González, S., 190, 343–370
 Goody, J., 290, 294
 Goos, M., 301, 319
 Göransson, K., 29
 Gorgorió, N., 349
 Goswami, U., 107
 Gould, P., 137–163, 263
 Gowar, N., 325–337
 Grabner, R.H., 160
 Graf, K.D., 43, 95
 Graham, A., 325–337
 Granà, A., 478
 Gravemeijer, K., 305
 Graven, M., 412
 Gray, M.L., 144
 Greer, B., 333
 Grevholm, B., 281
 Griesel, H., 117
 Griffin, S., 144, 484
 Gronn, D., 262, 263
 Gross, J., 479, 484
 Gross-Tsur, V., 484
 Groza, V.S., 100, 102
 Guala, E., 352
 Guberman, R., 300, 307
 Guimarães, L.C., 199, 301
 Guitel, G., 98, 101
 Guo, S.C., 56, 95, 102, 366

H

Hadden, T., 263
 Haggarty, L., 281
 Haizlip, J., 30
 Halai, A., 28, 36, 42, 221, 344
 Halberda, J., 480
 Hall, J.W., 173
 Hallett, D., 144
 Halliday, M.A.K., 350
 Halverscheid, S., 288

Hamilton, E., 314
 Hannula-Sormunen, M.M., 145, 146, 160, 382
 Harel, G., 467
 Harel, I., 484
 Harvey, R., 332
 Hasan, R., 350
 Hatfield, N., 337
 Havlíčková, R., 427
 Haworth, C., 479, 484
 Hayashi, T., 441
 He, S., 137–163
 Hejny, M., 428
 Helme, S., 199
 Henik, A., 143, 479
 Hewitt, D., 73, 75, 76, 83, 307
 Hiebert, J., 215
 Hill, H.C., 287
 Hilton, A., 301, 319
 Hilton, G., 301, 310, 319
 Hirsh-Pasek, K., 382
 Ho, C.S.H., 60
 Hoadley, U., 153, 412
 Hoard, M.K., 478, 479
 Hodge, N., 26
 Hodgson, B.R., 99, 182, 183, 190,
 227–248
 Hord, C.T., 376, 377, 388, 389
 Horne, M., 262, 263
 Houdement, C., 38, 49, 91–120
 Howe, R., 5, 8, 12, 39, 59, 125–134, 472
 Howson, G., 13
 Hoyles, C., 186, 195, 209
 Høyryup, J., 105, 106
 Hoyt, F., 456, 461
 Hříbková, L., 427
 Hu, B., 301
 Huang, R., 44, 265, 272, 420
 Hudson, C., 479, 484
 Hulme, C., 143
 Humberstone, J., 157, 393, 478, 481
 Hunter, J., 220
 Husain, M., 480

I

Ifrah, G., 37, 44, 45, 95, 97, 99, 344, 347
 Inglis, M., 159
 Inprasitha, M., 181–222, 280, 281, 399–431
 Irwin, K.C., 150
 Isaacs, E.B., 482
 Isoda, M., 208, 215, 414
 Ivrendi, A., 113
 Izard, V., 478
 Izsák, A., 106, 299–321, 405, 407

J

Jackiw, N., 73, 149
 Jacklin, H., 153, 412
 Jacobsen, L.E., 190
 Jagannathan, J., 30
 Jai-on, K., 214
 James, N., 327
 Jane, J.A. Jr., 30
 Jankvist, U.T., 94, 96
 Jaworski, B., 11, 21
 Jiang, C., 254, 289, 301
 Jing, M., 299–321
 Jirotková, D., 426
 Johnson, H.L., 388, 389
 Johnston-Wilder, S., 325–337
 Jonckheere, A.R., 481
 Jones, K., 13, 485
 Jordan, K.E., 478
 Jordan, N.C., 157
 Jullien, F., 3, 4, 352, 424
 Jury, M., 456, 461

K

Kaewdang, R., 414
 Kamii, C., 39
 Kanes, C., 114
 Kanwisher, N., 480
 Kaput, J.J., 318
 Karagiannakis, G., 376, 379
 Karp, A., 196
 Karuka, S., 42
 Kaur, B., 7, 16, 215, 251–282, 293, 318,
 399–431
 Kazima, M., 28, 36, 221, 344
 Keller, O., 99
 Kempinsky, H., 192, 194
 Kenney, R.H., 388, 389
 Kessel, C., 439–461
 Khemmani, T., 414
 Kho, T.H., 408
 Kieran, C., 62, 334
 Kieren, T., 325
 Kilpatrick, J., 20, 117, 120, 335, 440
 Kim, C.C., 350
 Kim, R.Y., 13, 76
 Kiro, C., 220
 Kirschner, P.A., 306, 335
 Klauber, M.R., 30
 Klein, D., 118
 Klessinger, N.J.C., 347
 Klieme, E., 118
 Kloboučková, J., 426
 Knott, L., 64

- Knuth, E.J., 55, 174, 314
 Ko, P.Y., 265, 269, 270
 Kochanek, P.M., 29
 Kollhoff, S., 182, 219
 Kordemsky, B.A., 197
 Kortenkamp, U., 181–222
 Kouba, V.L., 389
 Kovas, Y., 394, 479, 484
 Krajewski, K., 157
 Krifka, M., 37
 Kuhn, C., 153
 Kühne, C., 412
 Kullberg, A., 272
 Kwa, T.M., 55, 57
 Kwon, Y., 43, 60
- L**
- La Mont, K., 480
 Ladel, S., 181–222
 Lage, A., 479
 Lagrange, J.B., 186, 209
 Lajoie, C., 99, 181–222, 227, 233, 241, 247
 Lakoff, G., 74, 380
 Lam, L.Y., 37, 39, 44–49, 95, 96, 102, 106, 115, 193, 359
 Lamon, S., 281
 Landau, M., 314
 Landerl, K., 144, 376, 393, 394
 Lanigan, J., 482
 Laparra, M., 287–296
 Larsson, K., 299–321
 Laurillard, D., 197, 484, 485
 Lavric, E., 38
 Laycock, H., 81
 Le Bihan, D., 478
 Le Corre, M., 172, 480
 Lean, G., 64
 Lee, K., 411
 Lee, L., 334
 Leer, N.M., 150
 LeFevre, J.A., 157
 Lehtinen, E., 145, 146, 382
 Leikin, R., 405
 Lemaire, P., 156
 Lemay, F., 229, 240
 Lervåg, A., 143
 Lesgold, S.B., 150
 Lesh, R., 314
 Leung, F.K.S., 43, 95, 114
 Levenson, E., 12, 405
 Levin, S.R., 37
 Lewis, C., 430
 Lewis, J.M., 287
 Li, S., 44
 Li, S.P.T., 421
 Li, X., 56, 106, 193, 280, 289, 420, 439, 458
 Li, Y., 44, 61, 62, 265, 272, 420
 Liang, S., 420
 Lichtenfeld, S., 217
 Lijnen, T., 320
 Lilburn, P., 296
 Liljedahl, P., 328
 Lin, P.-J., 296
 Lipton, J., 480
 Littlefield, A., 478, 479
 Liu, F., 36, 43
 Liu, J., 388–391
 Livesey, C., 263
 Livneh, I., 114
 Lloyd, D., 221
 Lo Cicero, A., 111–113, 132
 Lo, M.L., 265, 269, 270, 418, 420
 Lombard, A., 153, 412
 Lopez-Real, F.J., 44, 95
 Loubet, M., 105
 Love, E., 335
 Lucangeli, D., 393, 394, 478
 Lucas, A., 482
 Luerssen, T.G., 30
 Luna, E., 343–370
 Luwel, K., 159, 162
 Ly, R., 480
 Lyons, I., 148
- M**
- Ma, L., 36, 55, 59, 62, 110, 112, 439–461
 Ma, Y., 137–163
 MacGregor, M., 329
 Maertens, B., 159
 Mailizar, L., 57, 281, 290
 Mainzer, K., 99
 Major, S.M., 43
 Malara, N., 335
 Mandarino, M.C., 199, 301
 Manor, O., 484
 Maracci, M., 148, 151–153, 161, 211, 212
 Margolinas, C., 105, 287–296
 Mariotti, M.A., 151, 186, 380, 381, 425
 Mark, J., 335, 337
 Marmarou, A., 30
 Marriott, A.J., 478
 Marshall, L.F., 30
 Marshall, M.N., 24
 Marshall, S.B., 30
 Martignone, F., 20, 32, 187, 402
 Martland, J., 263, 306
 Marton, F., 58, 265, 269, 270, 484

- Martzloff, J.-C., 46, 47, 49, 52, 56, 101–103
 Maschietto, M., 183, 210, 211, 348
 Mason, J., 304, 305, 310, 325–337
 Matar, M., 14
 Matsuzawa, T., 478
 Mattos, F.R., 199, 301
 May, K.O., 97
 Mazzocco, M.M.M., 376, 381, 480
 McCandliss, B.D., 382
 McCarthy, S.E., 480
 McClintock, E., 388, 389
 McDonald, B., 382
 McDonald, M., 118
 McDonough, A., 262, 263
 McFeetors, J., 93–94, 118
 McGarvey, L., 91–120
 McIntosh, A., 113
 McKnight, C., 279
 McMullen, J., 145, 146
 Meaney, T., 196
 Mellone, M., 64, 300, 303, 312–314, 353
 Meng, Y., 301
 Menninger, K., 37, 39, 40, 61, 97, 98, 106,
 189, 200, 344
 Mercier, A., 182, 290
 Merz, S., 159
 Metzuyanin, E., 347
 Michaux, N., 478
 Milinkovi, J., 137–163
 Miller, H.C., 29
 Miller, J., 221
 Miller, K.F., 43, 110, 131
 Misfeldt, M., 40, 93, 108, 112, 113
 Mitchell, A., 263
 Mitchelmore, M.C., 139, 145–146, 151, 153,
 161, 174, 383, 384
 Miura, I.T., 350
 Miyakawa, T., 420
 Molina, M., 336
 Molko, N., 478
 Moll, G., 139
 Moll, K., 394
 Monaghan, J., 188
 Monroe, W., 444
 Montgomery, P., 262, 263
 Monti, M.M., 347
 Moreno, L.D., 13
 Morgan, C., 114
 Mornane, A., 262
 Moro, M.I., 448
 Morrish, I., 114
 Morrison, S., 412
 Moschkovich, J., 28, 36, 221, 344
 Moss, J., 328
 Moxhay, P., 470
 Muke, C., 64
 Mulligan, J.T., 137–163, 174, 328,
 375–394, 428
 Murata, A., 60, 262
 Murayama, K., 217
- N**
- Naiman, D.Q., 480
 Narot, P., 414
 Navarra, G., 335
 Needham, J., 53, 101
 Neshet, P., 169–178
 Neto, T.B., 112, 402
 Newcombe, N.S., 382
 Newman, J.R., 126
 Ng, O.-L., 300, 307
 Ng, S.F., 411
 Ng, S.S.N., 44
 Ni, Y., 43, 57, 63, 181–222, 320
 Nie, B., 58
 Niemivirta, M., 157
 Nilholm, C., 29
 Ninowski, L.E., 144
 Niss, M., 13
 Niv, Y., 484
 Noël, M.P., 376, 382
 Nohda, N., 414
 Noss, R., 195
 Novotná, J., 7, 12, 16, 251–282, 288, 399–431
 Nowinska, E., 11, 21
 Nugent, L., 478, 479
 Nührenböcker, M., 187, 188
 Nunes, T., 144, 309, 321
 Núñez, R., 74
- O**
- Obersteiner, A., 137–163
 O'Connell, J., 456, 461
 O'Daly, I., 72
 Ohtani, M., 155, 184, 215
 Okamoto, Y., 350
 Okonkwo, D.O., 30
 Olivier, E., 478
 Ölmert, I.B., 106
 Ölmez, I.B., 299–321, 405
 Olson, S., 21
 Ong, W.J., 294
 Ordóñez, L.E., 112, 402
 Osherson, D.N., 347
 Ouzoulias, A., 345
 Owens, K., 64

P

Páchová, A., 427
 Paine, L., 420
 Pant, H.A., 139
 Papadatos, Y., 376, 379
 Papert, S., 484
 Papic, M.M., 328, 383
 Paraide, P., 64
 Parish, L., 150, 154, 182, 219, 263, 296
 Park, J.V., 388, 389
 Park, J.Y., 299–321
 Parsons, L.M., 347
 Partington, M.D., 29
 Pasch, M., 426
 Pattanajak, A., 414
 Pearn, C., 251–282, 293
 Peet, H., 456, 461
 Peeters, D., 159, 162
 Pekrun, R., 217
 Pelgrims, B., 478
 Peltenburg, M., 386, 387
 Pepin, B., 281
 Perret, J.F., 117
 Pesenti, M., 478
 Peter-Koop, A., 182, 183, 192, 199, 206, 207, 219
 Peters, G., 139, 144, 156
 Pettersson, K., 299–321
 Peverly, S., 207
 Pfannenstiel, K.H., 388
 Phelps, G., 287, 319
 Piaget, J., 144, 171, 172
 Piazza, M., 140, 142, 172, 393, 478
 Piffer, L., 478
 Pimm, D., 61, 71–85, 149, 182, 212, 325–337
 Pinel, P., 140, 142, 172, 478
 Planas, N., 28, 36, 221, 344, 349
 Plomin, R., 479, 484
 Plume, E., 479
 Poincaré, H., 364
 Pong, W.Y., 270, 484
 Poppink, S., 420
 Porter, A., 279
 Porterfield, J., 388
 Poulton, R., 220
 Powell, A., 79, 80
 Prasertcharoensuk, T., 414
 Pratt-Cotter, M., 62
 Prediger, S., 11, 21, 288
 Prenzel, M., 118
 Price, C., 478
 Price, D., 479, 484
 Prince, J., 456, 461

Proulx, J., 335
 Proust, C., 105, 106

Q

Qian, X.Q., 441
 Quilio, S., 182, 290

R

Rabardel, R., 186
 Radford, L., 200, 357
 Raizen, S., 279
 Ramatlapana, K., 412
 Ramineni, C., 157
 Ramploud, A., 58, 61, 64, 72, 73, 83, 299–321, 343–370, 425
 Ran, Y., 38
 Ranpura, A., 482
 Rao, N., 44
 Räsänen, P., 381, 484
 Reeve, R., 142, 157, 221, 346, 393, 478, 481
 Reigosa-Crespo, V., 479
 Reindal, S.M., 29, 30
 Reiss, K., 139
 Rendl, M., 426, 427
 Rendu, A., 144
 Resnick, L.B., 150
 Revkin, S., 484
 Reynaud, A.-A.-L., 103, 104
 Reynolds, F., 157, 221, 346, 393, 478, 481
 Reynvoet, B., 159
 Reys, B.J., 113, 279
 Reys, R.E., 113, 279
 Rieber, R.W., 185
 Rivière, D., 478
 Roberts, G., 388
 Roberts, N., 137–163, 174, 206
 Robinson, K.M., 144
 Robitaille, D.F., 279
 Robitzsch, A., 39, 183, 198, 387
 Robutti, O., 343–370
 Roche, A., 262, 263
 Rodriguez, M., 479
 Rogers, M., 482
 Rojas-Gamarra, M., 358
 Romanowsky, C.A.J., 347
 Roncagliolo, R., 343–370
 Ronda, E., 319
 Ross, S.H., 39, 62
 Rotman, B., 74
 Rottmann, T., 181–222
 Rourke, B.P., 391

- Roussos, P., 379
 Rowley, G., 262, 263
 Royer, J.M., 479
 Rubinsten, O., 143, 479
 Runesson, U., 253, 271, 279, 295, 299–321
 Runswick-Cole, K., 26, 456, 461
 Russell, B., 170, 171
 Ruthven, K., 112
 Ryan, D.W., 413
 Ryan, J., 103
- S**
- Salin, M.-H., 105
 Salminen, J., 484
 Sann, C., 478
 Santos, E., 479
 Sarama, J., 144, 209, 383
 Sarrazy, B., 253, 273, 288
 Sarungi, V., 181–222
 Sasanguie, D., 159
 Saulle, D., 30
 Saxe, G.B., 98, 276, 279, 345
 Sayac, N., 13
 Sayers, J., 91–120, 147, 157
 Schifter, D., 306, 312, 314
 Schipper, W., 205
 Schleifer, P., 144
 Schleppegrell, M.J., 351
 Schliemann, A.D., 176
 Schmandt-Besserat, D., 97, 100
 Schmidt, S.S., 159
 Schmidt, W., 279
 Schmitt, E., 412
 Schmittau, J., 151, 174, 402, 471
 Schneider, M., 159, 160
 Schneider, W., 157
 Schnitte, E., 153
 Schoenfeld, A.H., 158, 276, 303, 335
 Schollar, E., 412
 Schubring, G., 196
 Schukajlow, S., 13
 Schulte-Körne, G., 479
 Schulz, A., 206
 Schumacher, J., 479
 Schwartzman, S., 53
 Scorza, M., 150, 381
 Scudder, K.V., 188
 Seidenberg, A., 84, 97
 Selden, N.R., 29
 Selin, H., 344
 Selter, C., 262
 Semenza, C., 394
 Senft, G., 50
- Sensevy, G., 290
 Sepeng, P., 42
 Setati Phakeng, M., 28, 36, 71, 221, 344
 Sfar, A., 200, 304
 Shalev, R.S., 484
 Shallow, E., 456, 461
 Shapiro, B.J., 413
 Sheffield, L.J., 13
 Shen, J., 420
 Shield, M., 281
 Shimizu, S., 215
 Shir, K., 405
 Shu, H., 43
 Shulman, L.S., 287, 418
 Si, L., 299–321, 388, 389
 Siegal, M., 347
 Siegler, R.S., 43, 60, 144, 156, 159, 484
 Sierpinska, A., 20, 200
 Silver, E., 13
 Simon, M., 281, 333
 Sinclair, N., 61, 73, 78, 82–85, 137–163, 169,
 170, 172, 173, 182, 211, 212, 328, 347
 Singer, F.M., 13
 Singhal, A., 482
 Sitabkhan, Y., 14
 Siu, M.K., 53, 91–120, 195, 343–370
 Skuse, D., 478
 Skwarchuk, S.L., 157
 Sleep, L., 287
 Slovin, H., 301, 303, 308, 313, 403
 Smith, D.E., 443
 Smith, J.P., 311
 Smith, M.S., 215
 Smith, S.T., 111–113, 132
 Song, S., 456, 461
 Soury-Lavergne, S., 181–222, 348
 Sowder, J., 281
 Sowder, L., 281
 Sowinski, C., 157
 Spelke, E.S., 172, 478, 480
 Stacey, K., 199, 329
 Stafford, A.K., 263, 306
 Stanger, G., 263, 306
 Stanic, G., 440
 Starkey, G.S., 382
 Starkey, P., 478
 Steere, M., 350
 Steffe, L.P., 263, 325, 388
 Stein, M.K., 215
 Steinbring, H., 187, 188
 Stepanova, M., 358
 Stephan, M., 305
 Stephanou, A., 139, 146, 383, 384
 Stephens, M., 312, 325–337

Stephens, W., 304, 305, 310
 Stetsenko, A., 185, 186
 Stevenson, W., 10
 Stigler, J.W., 10
 Stoianov, I., 481
 Stokes, D.E., 158
 Streri, A., 478
 Stricker, J., 159
 Sullivan, P., 64, 262, 263, 296
 Sun, X.H., 3–16, 19–32, 35–65, 91–120, 192,
 251–282, 289, 343–370, 399–431
 Sun, Y., 52
 Suurtamm, C., 13
 Swafford, J., 335
 Sweller, J., 306, 335
 Sylva, K., 144, 309, 321
 Szeminska, A., 144
 Sztejn, E., 21

T

Tabach, M., 405
 Tabulawa, R., 306
 Tahan, M., 197
 Tahta, D., 73, 74, 78, 85, 326, 327, 334
 Tall, D., 405
 Tang, S.G., 441
 Taumoepeau, M., 220
 Taylor, N., 220, 412
 Tempier, F., 38, 39, 49, 93, 110, 113, 403
 Temple, C.M., 478
 Teo, T., 31, 418
 Terrace, H.S., 478
 Thames, M.H., 287, 319
 Thanheiser, E., 91–120, 129
 Theodore, R., 220
 Thomas, G., 263
 Thompson, A., 281
 Thompson, D.R., 13
 Thompson, I., 112
 Thompson, P.W., 311, 337
 Tirosh, D., 405
 Tom, K., 299–321
 Tomonaga, M., 478
 Torbeyns, J., 139, 144, 156
 Tornroos, J., 279
 Towers, J., 325, 335, 336
 Trafimow, D., 402
 Travers, K.J., 279
 Triandis, H.C., 402
 Trinick, T., 196
 Trisirirat, J., 414
 Trouche, L., 188

Trussardi, A.N., 393, 478
 Trustin, K., 220
 Tsamir, P., 405
 Tsatsaroni, A., 114
 Tse, S.K., 58
 Tshesane, H., 412
 Tsui, A.B.M., 265, 269, 270
 Turkenburg, K., 263
 Tzur, R., 333, 388, 389

U

Ufer, S., 13
 Umilta, C., 481
 Unterhalter, E., 30
 Usiskin, Z., 349
 Uttal, D.H., 188

V

Valdes-Sosa, M., 479
 Valero, P., 28, 36, 221, 344
 Valverde, G., 343–370
 van den Heuvel-Panhuizen, M., 39, 137,
 140, 148, 153, 154, 183, 198, 262,
 276, 278, 280, 281, 290, 305,
 375–394, 412
 van der Waerden, B., 440
 van Dooren, W., 299–321
 van Harskamp, N., 478
 van Hiele, P., 329
 van Hiele-Geldof, D., 329
 van Hoof, J., 320
 van Maanen, J., 200, 201
 van Zanten, M., 280, 281
 Varley, R.A., 347
 Vaughn, S., 388
 Veilande, I., 281
 Veldhuis, M., 251–282, 290
 Venenciano, L., 301, 303, 308, 403
 Venkat, H., 299–321, 399–431
 Verdine, B., 382
 Vergnaud, G., 174, 292, 293, 346, 405
 Verran, H., 40
 Verschaffel, L., 137–163, 299–321, 333,
 375–394
 Villa, B., 345, 353
 Villavicencio Ubillús, M., 28, 36, 221,
 344, 358
 Vinner, S., 405, 407
 Vleugels, K., 309
 Volkov, A., 45
 vom Hofe, R., 217

von Glasersfeld, E., 263
 Vondrová, N., 426, 427
 Vos, P., 13
 Vygotsky, L.S., 262, 484

W

Wald, M.M., 29
 Walker, M., 30
 Walker, N., 262
 Walles, R., 479
 Walsh, V., 478
 Wang, J., 44, 420
 Wang, L., 53
 Wang, Y., 57, 137–163, 281, 290
 Ward, M.B., 405
 Warden, C.W., 29
 Warfield, V., 295
 Warren, E., 221, 307
 Wartha, S., 206
 Watanabe, T., 215
 Watson, A., 155, 184, 215, 296, 310,
 325–337
 Watson, S.E., 143
 Wearne, D., 215
 Wechsler, D., 482
 West, M.M., 318
 Westaway, L., 412
 Whipple, A., 299–321
 Whitehead, A.N., 443
 Willburger, E., 394
 Wilmer, J.B., 480
 Wilson, A., 479, 484
 Wilson, S.M., 430
 Wing, T., 333
 Winsløw, C., 420
 Wiseman, A.W., 114
 Wisniewski, E., 81
 Wittgenstein, L., 73, 80, 81
 Wollock, J., 185
 Wong, I.N., 254, 289
 Wong, N.Y., 44
 Wood, F., 485
 Wood, P., 478, 479
 Woodward, J., 388, 389
 Woolcott, G., 139, 146, 159, 384, 428
 Wozniak, F., 105
 Wright, D.W., 29
 Wright, R.J., 263, 306

Wright, T., 301, 310, 319
 Wylie, A., 45
 Wynn, K., 446

X

Xie, S., 137–163
 Xie, X., 44, 186
 Xin, Y.P., 279, 299–321, 375–394
 Xu, B., 440
 Xu, F., 36, 43, 478
 Xu, L., 29

Y

Yang, D.-C., 137–163, 280
 Yang, N., 301
 Yang, Y.Q., 64, 441
 Yao, Y., 144
 Yeo, D., 484
 Yeoh, H.K., 30
 Yogev, A., 114
 Young-Loveridge, J., 39, 150, 153,
 181–222, 263

Z

Zan, R., 63
 Zaslavsky, C., 37, 40, 196, 197, 344
 Zaslavsky, O., 405
 Zazkis, R., 328, 405
 Zeffiro, T., 485
 Zenigami, F., 301, 303, 308, 403
 Zhang, D., 299–321, 360
 Zhang, J., 301, 420
 Zhang, Q.-P., 280, 281, 293
 Zhao, L.Q., 441
 Zhao, X., 279, 290
 Zhao, Y., 118
 Zhen, J., 420
 Zhou, Y.-D., 320
 Zhou, Z., 207
 Zhu, J., 110, 131
 Ziegler, A., 479
 Ziman, J., 72
 Zorzi, M., 481
 Zou, D., 48, 49, 59, 92, 102, 190
 Zuo, H., 106, 193, 280, 289
 Zwicky, J., 73

Subject Index

A

- Abacus, 10, 54, 61, 76, 104–106, 115, 182, 188, 191–193, 199–201, 204–206, 215–216, 240, 340, 358
- Aboriginal, 26, 142, 221, 499
- Abstract number, 443
- Academic theory, 127, 128
- Activity theory, 186
- Adaptive learning technology, 484
- Addends, 176, 447
- Adding combinations of one-digit and two-digit numbers, 261
- Addition, 53, 61, 98, 113, 132, 263, 446–452, 468
- Addition-subtraction, 144
- Additive, 98, 106, 138
 - reasoning, 154
 - relations, 148
 - structures, 292
 - system(s), 100, 107
- a-didactical situations, 273
 - of action, 273
 - of formulation, 273
 - of validation, 273
- Affective
 - axis, 333
 - issues, 222
- Africa, 25, 36, 40–43, 196
- African languages, 42
- Afrikaans, 28
- Algebraic
 - structure, 127–129
 - thinking, 58, 266, 288
- Algeria, 25, 30, 41, 93, 108, 109, 348–351
- Algerian, 109, 110
- Algorithms, 235, 469
- AMPS, *see* Awareness of mathematical pattern and structure (AMPS)
- Analogical quantity/magnitude code, 142
- Analogue number system (ANS), 141, 480
- Ancient artefacts, 188
- Ancient Egyptian numerals, 78
- Applying positional notation, 103
- Approaches to teach WNA, 279
- Approximate numerical expressions, 38
- Approximation, 37
- Arabic, 26, 28, 41, 95, 109, 126, 198, 350
- Area, 471
- Arithmetic course, 228
- Arithmetic operations, 53–55, 61–62
- Arithmetic racks, 204
- Artefacts, 151, 181–222, 228, 312
 - for low achievers, 202–204
 - for multiplication, 188
- Asemantic route, 142
- Assessment, 24, 30–32, 278, 287
- Associative, 440
- Associative property, 458
 - of addition, 459
 - of multiplication, 460
- Associative rule, 128–129
- Associativity, 239
- Attention, 329–330
- Australia, 25, 26, 28, 30–32, 219, 261, 263, 278, 280, 346
- Australian, 221, 254
- Australian Pattern and Structure Mathematics Awareness Project, 383

Awareness of mathematical pattern and structure (AMPS), 145, 151, 153, 161
 Axioms, 333, 440

B

Babbling, 335
 Babylonian(s), 105
 Balance, 55
 Bantu, 42, 43, 221
 Base-ten, 125
 blocks, 357
 pieces, 127
 place value, 134
 structure, 134
 unit, 128
 Basic laws of arithmetic, 239
 Bead calculations, 115, 204
 Belgium, 25, 26, 28, 31
 Berber, 41
 Big numbers, 129, 220
 Bilingual, 41, 221
 Bolivia, 356
 Borrowing, 61, 73, 457
 Brazil, 25, 198
 Brick in the wall, 244
 Burundi, 42

C

Canada, 25, 26, 31, 118–119, 183, 261
 Cantonese, 28
 Capability approach, 30
 Capacity and network projects (CANP), 487–492
 Cardinal, 72, 83–84, 169, 171
 models, 428
 numbers, 60, 233
 type, 98
 Cardinality, 62, 172
 Cargo method, 240
 Carrying, 61
 Casting out nines, 247
 Characters, 58
 China, 21, 25, 30–32, 37, 64, 92, 95, 105, 115, 118, 119, 126, 193, 201, 254, 279, 281, 351–355
 Chinese, 36, 38, 44–59, 79, 98, 101, 110, 113, 126, 189, 190, 192, 207, 220, 253, 254, 345, 358–363
 approach, 43–44
 area, 30, 31
 curriculum, 112
 decimal system, 102

 schools, 22
 spoken number names, 131
 tradition, 44
 Chunka, 98
 Circle Hotel, 244
 Classical theory, 103
 Classifiers, 47–51, 80
 Classroom assessment, 276–279
 Clock arithmetic, 242–243
 Closed answer form, 281
 Cognitive
 axis, 333
 issues, 221
 Cognitively demanding tasks, 215–218
 Column units, 49
 Combinatorial task, 217
 Commutative, 440
 Commutative property, 458
 of addition, 458
 of multiplication, 460
 Commutativity, 144, 236, 239, 288, 468
 Comparative studies of textbooks, 280
 Compatibility, 239
 Compensation
 principles, 440
 property for addition, 459
 property of multiplication, 461
 Composing/decomposing numbers, 52
 Composite unit, 155
 Composition and decomposition, 107, 362
 Computational
 algorithms, 106, 126, 441, 466
 efficacy 127
 estimation, 139
 flexibility, 144
 ideas, 206
 methods, 126
 processes, 139
 skills, 119, 391
 solutions, 311
 strategies, 156
 technological devices, 72–73
 tools, 126
 Computer games, 183
 Concept images, 333
 Conceptual /relational meaning, 62
 Conceptual
 aspects, 465
 development of place value, 474
 foundations, 466
 issues, 469
 models, 466
 structures, 145
 understanding, 60, 467, 472

- Concrete number, 51, 443
 Concrete-pictorial-abstract (CPA) approach, 408
 Connaissance (a knowing), 272
 Connections between topics, 281
 Connectivity across concepts, 139
 Content knowledge, 430
 Convenience sample, 24
 Conversion, 47–48, 102, 107, 427
 Costa Rica, 255
 Countable noun, 80, 81
 Counting, 60, 99, 170, 171, 207–208, 230, 446, 465–467
 boards, 47, 73
 principle, 97
 rods, 45, 47, 53, 188, 353
 Count-to-cardinal transition, 143
 Creative mathematical thinking, 263
 Critical places of basic school mathematics, 426
 Cross-cultural study, 154–155
 Cross-sectional, 139
 Cuisenaire rods, 170, 182, 199, 234, 240, 332, 357
 Cultural
 artefacts, 184–198
 constraints, 220–221
 diversity, 19
 transposition, 36, 64, 210, 312–314, 352–355, 364
 Culture(s), 36, 91, 94, 95, 107–117
 of gesture, 72
 of speaking, 72
 of writing, 72
 Curriculum, 32, 93, 106, 110–113, 125, 129
 Curriculum Reform, 118–119
 Cushitic, 42, 221
 Cutting and paste, 56
 Cypherization, 78
 Cyprus, 25, 28
 Czech Republic, 25, 28
- D**
 Dance, 189
 Danish, 40, 108–110, 113, 131, 350
 D-books, 189
 Decimal
 division, 116, 310
 equivalence, 77
 expansions, 247
 finite decimals, 467
 form of rational numbers, 110
 fractions, 48, 76, 83, 103, 113
 infinite representation, 469
 marker, 79
 money context, 318
 multiplication, 310, 358–359
 numbers, 71, 351
 numeration system, 45, 358
 place value system, 45, 94–96, 101–104, 106–107, 306, 360
 position system, 108, 348–350
 principles, 39, 60, 93
 structure, 308, 402
 units, 102, 110
 value, 75, 78
 Decomposing and recomposing, 153
 Definitions, 405, 440
 Democratic Republic of Congo, 42
 Denmark, 25, 31, 93, 108–109
 Design of activities, 186
 Devolution, 274, 296
 Diagnosis, 378
 Didactical cycle, 186
 Didactical situation, 273
 Didactic tension, 336
 Dienes block(s), 76–78, 81
 Difference, 449
 Differentiating tasks and instruction, 263
 Digit(s), 41, 72, 440
 Digital Assessment Environment (DAE), 387
 Digital textbooks, 214
 Direct instruction, 335
 Discovery learning, 335
 Distance effect, 148, 478
 Distance learning, 32
 Distributive property, 440, 457, 460
 Distributivity, 239
 Dividend, 455–456
 Divisibility criteria, 247
 Division, 116, 133, 452–456
 Division with remainder (DWR), 116, 133
 Divisor, 455–456
 Dominican Republic, 25, 357
 Dot enumeration, 157, 481
 Dots2Track game, 485
 Dutch, 26, 281
 Dyscalculia, 8, 161, 378–382, 392, 479, 482
- E**
 Early algebra, 300, 302, 311, 320
 Early numeracy research project, 263
 East African Countries, 42–43
 East Asia, 110

- Egyptian(s), 100, 102
 hieroglyph, 73
 numeration, 77, 240
 Egyptian hieroglyph, 73
 Egyptian numeration, 240
 Electronic calculators, 115
 Elements, 440
 Emphasis on algorithms, 281
 Enactive axis, 333
 England, 25, 183
 English, 26, 28, 38, 40, 41, 50, 53, 57,
 60, 62, 110, 111, 113,
 127, 349
 Enumerating World, 149
 Environmental
 deprivation, 376
 factors, 479, 482
 stressors, 484
 variables, 157
 e-Pascaline, 210–211
 Epistemological
 context, 242
 issues, 221
 nature of tradition, 344
 obstacle, 200
 Equality, 56–59, 62–64
 Equalizing, 56
 Equal sign, 56
 Equations, 405
 Equipotency, 232
 Equivalence, 55
 Esann, 28
 Euclidean algorithm, 245
 Europe, 95, 118
 European, 93
 Everyday
 artefacts, 189, 198, 202
 calculation, 261
 Chinese arithmetic, 36
 context, 178, 188
 environment, 177
 expression, 80
 language, 37–38, 60, 110, 221, 345,
 350–351
 life, 7, 41, 109, 182, 201–202, 441
 situations, 262
 tools, 195
 words, 333
 Exclusion, 28, 29
 Exercise Elastics, 332
 Expanded form, 128
 Explicit variation, 265
 Extended counting, 154
- F**
 Face value, 107, 110
 Factorials, 247
 Factors, 453–454
 Figurate numbers, 195, 234
 Finger gnosis, 211, 482
 Fingu, 212
 Finnish, 28
 Five stages of place value, 128
 Foldable strips, 202
 Formative assessment, 262
 Foundational number sense (FoNS), 147
 Four-phase-model, 206, 207
 Fraction(s), 38, 52–53, 61, 73, 83–84, 116,
 247, 468
 naming, 61
 terms, 82
 France, 25, 28, 31, 93, 109, 117–118, 127,
 254, 280
 French, 26, 28, 38, 40, 41, 62, 109–111, 183,
 272, 345, 349
 Frieze, 328
 Functioning of activities, 186
- G**
 Game of the Goose, 195
 Games, 189
 Gattegno number chart, 78
 GCD, 244–245
 Gelosia
 lattice multiplication, 195
 method, 236
 scheme, 188
 General, 300, 302, 304, 305, 307, 309,
 311–314, 318, 319
 Generalists, 24, 422
 Generalization, 325
 Generalizing, 146
 German, 26, 28, 38, 40, 108, 183, 350
 Germany, 25, 28, 30, 31, 219, 261, 280
 Gesture, 73, 74
 Graphical representation, 146
 Great Mekong Area, 184
 Greece, 106
 Greek(s), 28, 53, 102, 105, 127
 (ionian) numerals, 78
 numeration system, 126
 Grifuna, 41
 Grouping, 53, 62, 473
 Growth points, 263
 Guatemala, 41, 108, 356
 Guatemalan, 41

H

Haptic symbolic devices, 149
 Hawaiians, 190
 Hebrew, 28
 Help learning, 181
 Hermeneutic listening, 33
 Hieroglyphic numerals, 77
 Hinder learning, 181
 Hindu-Arabic
 numerals, 74, 78, 107, 109, 114
 numeral system, 37–38, 45, 95–96
 Historical development, 134
 Historic-cultural school, 184–186
 History, 91, 96
 Holding wholes, 329
 Home language, 28
 Homogenizing, 56
 Hong Kong, 43, 254, 280
 Horizontal expressions, 440
 Hungarian, 28

I

ICD-10-CM code, 391
 ICME-13, 488
 ICMI, 229, 230, 233
 ICMI Study 6, 13
 ICMI Study 8, 20
 ICMI Study 13, 472
 ICMI Study 15, 11, 32
 ICMI Study 17, 209
 ICMI Study 21, 221
 ICMI Study 22, 155, 184
 ICMI Study 23, 15, 22, 140, 184, 251, 252,
 282, 299, 368, 378
 Iconic images, 153
 Incas, 105, 190, 358
 Inclusion, 26, 28–30
 Inclusiveness, 23, 26, 28–30, 32
 Indeterminacy, 37
 Indexical images (generic), 153
 India, 25
 “Indigenous,” 265
 Indo-European languages, 36
 Indonesia, 254, 281
 Institutional
 constraints, 219
 context, 182
 Institutionalization, 274, 296
 Integration, 28–29
 Intentionality of teaching, 270
 Inter-American Conference on Mathematics
 Education (IACME), 13

Interest-dense situations, 288
 International Congress on Mathematical
 Education (ICME), 13
 Internship, 32
 Interpretative reading, 71
 Intervention, 139
 studies, 158
 IQ, 479
 Ishango, 99
 Israel, 25, 28, 32, 115–117, 281
 Italian, 28, 38, 40, 183, 345, 349
 Italy, 25, 28, 29, 31, 32, 63, 64, 204,
 351–355
 Iterating a unit of repeat, 146

J

Japan, 21, 43, 44
 Japanese, 31, 192
 Jordan, 25, 28, 30, 254

K

Kapa haka, 196
 Kenya, 42, 219
 Kinaesthetic, 160
 Kiswahili, 42
 Knowledge of the students, 263
 Korea, 44

L

Ladino, 41
 Ladybug Count, 212
 Language(s), 91, 98, 107–117, 220
 Large number, 130
 Latin, 53, 56, 105
 Latin alphabet, 350
 Latin America, 25, 40–43, 355–358
 LDM, 388, 389
 Learner’s processes, 205
 Learning trajectories, 261–265
 Least common multiple (LCM), 244–245
 Length, 471
 Length units, 47
 Lesson plan, 278
 Lesson study, 183, 414, 423
 Like numbers, 440, 443
 Linear arithmetic, 199
 Logical thinking, 255
 Long division, 118
 Long Hotel, 244
 Longitudinal, 139

M

Macao, 32, 43, 254–261, 279
 Magnitude, 84
 representations, 141
 understanding, 159
 Make-a-ten, 114
 Malay, 28
 Mancala, 197
 Mandarin, 28
 Manipulatives, 187
 Maori, 220, 345
 Marton's variation theory, 269–272
 Mass nouns, 81
 Mathematical
 enculturation, 344
 induction, 239
 knowledge for teaching, 269, 287
 meaning, 204–208
 practice, 405
 proficiency, 335
 reasoning, 262
 structure, 325
 tasks, 184, 215–218, 228
 Mathematician community, 115–117
 Mathematics Olympiads, 281
 Maya, 41
 Mayan, 41, 101, 356
 Meankeli, 28
 Measure, 465–467
 Measurement, 60
 Measuring, 207, 230, 466
 Measuring number, 233–235
 Memorization activities, 288
 Mental
 number line, 140, 480
 representation of number, 478
 Mesopotamia, 105
 Meta-cognitive, 146
 Metaphor, 37
 Midland Mathematics Experiment, 326
 Migrant/refugee/marginalized students, 23
 Milieu, 273
 Minorities languages, 28, 30
 Minuend, 53, 449
 Model method, 407, 408
 Models, 412
 Modern artefacts, 198–199
 Mother's language, 72
 Multibase arithmetic blocks, 182, 199, 241
 Multi-method approach, 162
 Multiple Problem One Solution (MPOS), 58
 Multiplicand, 453–454
 Multiplication, 56, 82, 98, 127, 128, 132, 405,
 452–456, 468

 table, 106–107
 Multiplicative, 39, 105, 106
 concept, 101
 reasoning, 154
 structure, 128
 thinking, 138
 Multiplicative-additive system, 101–102
 Multiplier, 453–454
 Multitouch technologies, 198, 211–213

N
 Napier's bones, 188, 195, 236
 National Council of Teachers of Mathematics
 (NCTM), 12, 31
 National Standards, 30–31
 Native language, 109
 Natural language, 71
 NCTM, *see* National Council of Teachers of
 Mathematics (NCTM)
 Ndebele, 28
 Near-universal conventional mathematics, 344
 Netherlands, 25, 28, 278, 280
 Neural basis of mathematics, 478
 Neuro-cognitive, 140
 Neuroimaging, 377
 Neuropsychological studies, 478
 Neuroscience, 140, 172
 New Math, 117–118, 120, 127
 New Zealand, 25, 28, 31, 196, 220, 263
 New Zealand Sign Language, 28
 Nigeria, 98
 Nilotic, 42, 221
 Nine nines song, 193
 Nominal aspect, 465
 Non decimal system, 108
 Non-example, 175
 Nordic network of research on mathematics
 textbooks, 281
 North America, 62, 118
 Northern Sotho, 28
 Notation, 116, 465
 Number, 41
 competence, 140
 module, 481
 names, 95, 108–109
 naming, 35, 108–109
 structure, 110
 words, 82, 85
 Number line, 140–141, 182, 188, 195, 202,
 209, 234, 351–352, 467
 Numeral, 71, 85, 440
 Numeral systems, 99–104
 Numeration, 38, 97, 98

- Numeration unit(s), 48, 49, 102, 103, 107, 110, 113, 118
- Numerical
 expressions, 134
 magnitude, 142
 units, 80
- Numerons, 480
- Numerosity, 230, 232, 480
- Numicon, 332
- Numro, 41
- Nursery rhymes, 231, 288
- O**
- Objects, 171
- Object-tracking system (OTS), 479
- Oceania, 64
- Oksapmin people, 98
- Old Babylon, 106
- One Problem Multiple Changes (OPMC), 58, 265
- One Problem Multiple Solutions (OPMS), 58, 266
- One-to-one correspondence, 97, 104, 107, 170, 232, 238
- Opacity, 182
- Open class approach, 413–418
- ‘Open-Class Model’ Program, 423–425
- Open task, 262
- Opportunity-to-learn (OTL), 279
- Ordinal(s), 83–84, 170, 412, 428
 numbers, 169
 terms, 82
- Ordinality, 140, 148, 169
- P**
- Palaeolithic, 97
- Panare, 98
- Papua New Guinea, 64
- Paralinguistic, 74
- Parking, 326
- Partitioning, 161
- Partitive division, 455
- Part-part-whole structure, 47, 51–52
- Part-whole relations, 140, 150
- Pascaline, 210–211
- Pattern(s), 146, 217–218, 303, 304, 307, 331
- Pattern and structural relationships, 139, 169
- Pattern and Structure Assessment (PASA), 154
- Pattern and Structure Mathematics Awareness Program (PASMAMP), 146
- Paying back, 73
- Pedagogical content knowledge, 287, 413–414, 430
- Pedagogical knowledge, 264
- Perceiving properties, 329
- Peru, 356
- PGBM-COMPS, 388
- Pictorial and abstract representations, 262
- Pithy tables, 188, 192
- Place value, 38–39, 47, 50, 59–60, 72, 74–80, 84, 95, 112, 132, 199–202, 348, 467, 472–474
 chart(s), 202, 212
 notation (PVN), 125–129
 numeral systems, 103
 system, 102
- Planning, 287
- Please Go Bring Me (PGBM), 388
- PME, 20
- Poems, 189
- Policy makers, 114
- Positional, 106
 notation, 38, 102, 127
 numeration, 246–247
 principle, 39, 106
- Practicum, 32
- Pragmatics, 37
- Pre-algebra, 150
- Pre-history of numbers, 104–105
- Pre-service primary school teachers, 183
- Primitive conception, 442
- Principles, 173
 of addition/subtraction, 51
 of division, 51
 of multiplication, 51
 of place value, 131
- Problem-solving, 428, 430
- Procedural/operational meaning, 63
- Product, 452
- Project-based practice, 255
- Proofs without words, 245–246
- Properties, 304–306, 308, 309, 311, 312
- Proportion, 405
- Prospective teachers, 227
- Proto-quantitative part-whole schemas, 150
- Pythagoras tables, 236, 246
- Q**
- Qualitative and holistic assessments, 276
- Quantifier, 171
- Quantitative relations, 144–147
- Quantity, 465
 discrimination, 147
 value, 110, 112

Quechua Collao, 356
 Quipus, 105, 188, 190–192, 220
 Quotient, 455–456
 Quotitive division, 455

R

Radicals, 51
 Real-world, 415, 417
 Reasoning on the basis of agreed properties, 329
 Reckoning, 230
 Reckoning number, 235–236
 Recognizing relationships, 329
 Recreational mathematics, 197
 Reform, 119
 Regrouping, 62, 457
 Relational/conceptual meaning, 57
 Relational thinking, 62–64
 Relations, Relationships, 300, 302–307, 309–310, 312, 314, 320–321
 Remainder, 455–456
 Remedial interventions, 378
 Representational structures, 140
 Representation/model, 187, 430
 Retenue, 62
 Roman, 105, 126, 191
 Etruscan numerals, 99
 numeral(s), 99, 101–102, 105
 numeration, 240
 Romanian, 28
 Romansh, 28
 Roman written numerals, 102
 Round numbers, 38
 Russia, 25
 Russian, 192, 229
 Rwanda, 42

S

Sameness, 55
 Samic, 28
 Saudi Arabia, 254, 281
 Savoir (knowledge), 272
 Scaffolding, 474
 Schème, 346
 Scholarly knowledge, 186
 School
 language, 28
 mathematics, 413, 414
 Schoty, 191
 Science and technology, 117–118
 Second expanded form, 129
 Segregation, 28, 29

Selecting, 287
 Semiotic potential, 186
 Semiotic representations, 344–348
 Sensorimotor, perceptive and kinaesthetic-tactile, 151
 Sequences of tallies, 231, 233
 Serbia, 25, 28, 31
 Serbian, 28
 Seriation, 172
 SFON, *see* Spontaneous focusing on numerosity (SFON)
 SFOR, *see* Spontaneous focusing on quantitative relations (SFOR)
 Shanghai, 43
 Simbiti, 42
 Simplification, 239
 Simultaneous equations, 56
 Singapore, 25, 28, 30, 31, 43, 254, 261
 method, 333
 Singular/plural noun, 80–81
 Six-column sieve, 243
 Skip counting, 150
 Slavonic abacus, 182, 205, 216
 Socio-cultural aspects, 181
 Songs, 189
 Soroban, 61, 191
 South Africa, 25, 28, 30, 31, 253, 279
 South African, 253
 South-East Africa, 183
 Southeast Asia, 25, 126
 Southern Europe, 195
 Southern Sotho, 28
 South Korea, 43
 Spanish, 28, 38, 41, 349, 356
 Spatial
 awareness, 331
 structuring, 145
 visualization, 146
 Specialist mathematics teacher, 422
 Specialists, 24, 31, 419
 Special schools, 28
 Spelling reading, 71
 Spike abacus, 61, 199
 Spirograph, 244
 Spoken
 counting system, 75
 language based numeration system, 75
 languages, 40
 numbers, 72, 98
 Spontaneous, 146
 focusing on numerosity (SFON), 145, 147, 161
 focusing on quantitative relations (SFOR), 145, 147, 161

- Standard
 column-wise procedures, 132
 counting unit, 77
 Standards, 24, 32
 Starter kit, 141
 Stellenwerttafel, 212
 Strategic thinking, 429
 Strategies, 262
 Strategy
 efficiency, 156
 flexibility, 156
 Strip diagram, 407
 Structural
 groupings, 147
 names, 132
 perspective, 230
 relations/relationships, 151, 428
 Structure(ing), 174–176, 302, 304, 306, 307,
 309, 314, 317, 318, 321
 of artefacts, 153
 sense, 153
 Students with special needs, 26
 Suàn pán, 47, 49, 54, 61, 191
 Subitizing, 141, 172, 197, 212, 232, 479
 Subtraction, 53, 61, 98, 113, 446–452, 468
 strategies, 263
 Subtrahend, 53, 449
 Successor, 170, 173, 231
 Suffix, 83
 Sum, 176, 446
 Swati, 28
 Sweden, 25, 28, 31, 32
 Swedish, 28
 Switzerland, 25, 28, 31
 Symbolic, 153
 Symbol to symbol connections, 138
 Symposium on Elementary Mathematics
 Teaching (SEMT), 12
 Système Internationale (SI), 76
- T**
- Taiwan, 25, 43
 Tally, tallies, 97, 99–100, 182, 188, 230, 237,
 240–242
 Tamil, 28
 Tanzania, 42–43, 221
 Task design, 158–160
 Tasks, 181–222, 325
 Taught knowledge, 186
 Teacher education, 183, 222
 and development, 24, 31–32
 Teachers' knowledge of pedagogy, 261–265
 Teaching aids, 187
- Teen numbers, 131
 Temporal, 150
 Ten-to-one, 107
 Te Reo Maori, 28
 Textbooks, 23, 24, 30, 189, 198, 279, 413–415
 Thai, 28, 93, 281
 Thailand, 25, 28, 30, 31, 183, 261, 281
 Theory of didactical situations (TDS), 272
 Theory of school arithmetic, 456
 Theory of semiotic mediation, 186–187, 219
 Thought experiment, 205–207
 Tiny numbers, 53
 Tongwen Suanzhi, 280
 TouchCounts, 138, 211
 Tracking arithmetic, 327
 Transcoding, 39, 142–143, 201
 Transparency, 182, 220
 Transposition of the open-class approach, 422
 Triple-code model, 142
 Tsonga, 28
 Tswana, 28
 Tunja sequences, 330
 Turkish, 28
 Turner's Syndrome, 478
 -ty numbers, 131
 Types of knowledge, 272
- U**
- Uganda, 42
 UK, 28, 32
 Understanding, 262, 276
 Ungrouping, 53, 62
 Unit(s), 80–83, 102, 107, 110, 112, 442, 470
 conversions, 107
 of measure, 152
 of measurement, 174, 466
 of repeat, 146
 Unity of theory and practice, 421
 Universal Primary Education (UPE), 26
 USA, 25, 28, 30, 32, 39, 59, 128, 130, 131,
 219
 US numeration, 130
- V**
- Variable, 74
 Variation, 58, 325, 334
 efficiency and flexibility of representations,
 139
 problems, 36, 64, 361
 theory, 265
 Vedic verses, 196
 Venda, 28

Verbal code, 142
Verbal language, 221
Video clips, 10
Vietnam, 25, 30, 44
Virtual
 artefacts, 211
 manipulatives, 183, 187, 209
Visual Arabic code, 142
Visual
 imagery, 153
 proofs, 234
Visual-spatial, 150
Visuospatial reasoning, 64
Volume, 471

W
Watch What You Do (WWYD), 327
Weaknesses, 281
Weight, 471
Whole number addition and subtraction,
 261–263

WNA curriculum, 279
Word problems, 333, 427
Working memory, 479
Work problems, 441
Written numbers, 110
Written numerals, 74, 79
Written numeration system, 78

X
Xhosa, 28
Xinka, 41

Y
Yoruba, 98
Yupana, 106, 188, 358

Z
Zanzibar, 42
Zulu, 28